

Brodart Contract Furniture
2017 Price List and Specifications



2017 Price List and Specifications Addendum

Brodart Co. Contract Furniture - Made in USA

280 North Road, Clinton County Industrial Park • McElhattan, PA 17748

Toll-Free: 888-521-1884 • E-Mail: furniture@brodart.com • www.brodartfurniture.com

Table of Contents

2017 Price List and Specifications

General Specifications and Modifications

General Specifications.....GEN 1 - GEN 8

Modifications & Up Charges.....MOD 1 - MOD 8

Collections

The Abridge Collection.....ABR 1 - ABR 44

Circulation Desks..... ABR 2 - ABR 15
 Reading Tables..... ABR 16 - ABR 21
 Computer Tables..... ABR 22 - ABR 26
 Media Workstations & Carrels..... ABR 27 - ABR 34
 PAC Stations..... ABR 35
 Dictionary / Atlas Stands..... ABR 36
 Shelving Continuous Tops..... ABR 37 - ABR 39
 Lounge Furniture..... ABR 40 - ABR 44

The Chancellor's Collection.....CHA 1 - CHA 36

Circulation Desks.....CHA 2 - CHA 15
 Reading Tables.....CHA 16 - CHA 19
 Computer Tables.....CHA 20 - CHA 21
 Media Workstations & Carrels.....CHA 22 - CHA 29
 Dictionary / Atlas Stands.....CHA 30
 Shelving Continuous Tops.....CHA 31 - CHA 33
 Lounge Furniture.....CHA 34 - CHA 36

The Epoch Collection.....EPO 1 - EPO 60

Circulation Desks.....EPO 2 - EPO 26
 Reading Tables.....EPO 27 - EPO 32
 Computer Tables.....EPO 33 - EPO 35
 Conference Tables.....EPO 36 - EPO 38
 Media Workstations & Carrels.....EPO 39 - EPO 48
 PAC / OPAC Stations.....EPO 49 - EPO 50
 Dictionary / Atlas Stands.....EPO 51 - EPO 52
 CD/DVD Cabinets.....EPO 51 - EPO 53
 Shelving Continuous Tops & End Panels.....EPO 54 - EPO 57
 Lounge Furniture.....EPO 58 - EPO 60

Geometrix.....GEO 1 - GEO 52

General Specifications and Legend.....GEO 2 - GEO 8
 Linear Shelving.....GEO 9 - GEO 17
 Arc (Curved) Shelving.....GEO 18 - GEO 26
 3-Way Towers and Components.....GEO 27 - GEO 33
 Finishing Panels for Shelving.....GEO 34
 Mobile Shelving (Linear and Arc).....GEO 35 - GEO 36
 Back Panels (Linear, Arc, and Mobile).....GEO 37 - GEO 46
 Seating (Linear and Arc).....GEO 47 - GEO 50
 Tables.....GEO 51 - GEO 52

The Horizons Collection.....HOR 1 - HOR 32

Circulation Desks.....HOR 2 - HOR 13
 Reading Tables.....HOR 14 - HOR 21
 Media Stations.....HOR 22 - HOR 26
 Book Browsers.....HOR 27 - HOR 28
 Shelving End Panels.....HOR 29
 Seating.....HOR 30 - HOR 31
 Cutout Designs.....HOR 32

The Matrix Collection.....MAT 1 - MAT 44

Circulation Desks.....MAT 2 - MAT 15
 Reading Tables.....MAT 16 - MAT 27
 Computer Tables.....MAT 28 - MAT 31
 Media Workstations & Carrels.....MAT 32 - MAT 38
 PAC Stations.....MAT 39
 Dictionary / Atlas Stands.....MAT 40
 Shelving Continuous Tops & End Panels.....MAT 41 - MAT 44

The Maxim Collection.....MAX 1 - MAX 16

Circulation Desks.....MAT 2 - MAT 16

The Quorum 94T Collection.....QUO 1 - QUO 32

Reading Tables.....QUO 2 - QUO 7
 Café Tables.....QUO 8 - QUO 9
 Computer Tables.....QUO 10 - QUO 12
 Media Workstations & Carrels.....QUO 13 - QUO 19
 PAC Stations.....QUO 20
 Desk and Credenzas.....QUO 21 - QUO 23
 Dictionary / Atlas Stands.....QUO 24
 Newspaper Rack & EOR Station.....QUO 25
 Picture Book Table.....QUO 26
 Shelving Continuous Tops & End Panels.....QUO 27 - QUO 30
 Lounge Furniture.....QUO 31 - QUO 32

Array Tables.....ARY 1 - ARY 12

mTables.....MTA 1 - MTA 8

Reading Tables.....MTA 2 - MTA 6
 Computer Tables.....MTA 7 - MTA 8

Mobile Tables.....MOB 1 - MOB 4

Sync Tables (Collaborative Tables.).....SYN 1 - SYN 4

Collection Accessories.....ACC 1 - ACC 4

Shelving

Classic Shelving.....CLA 1 - CLA 48

Shelving.....CLA 2 - CLA 39
 Shelving and Accessories.....CLA 40 - CLA 48

Reprise Shelving.....REP 1 - REP 36

Shelving.....REP 2 - REP 34
 Shelving and Accessories.....REP 35 - REP 36

Seating

Seating.....Various

Alpha Chairs.....ALP 1
 Banbury Chairs.....BAN 1 - BAN 2
 B-Series Chairs.....BSE 1 - BSE 8
 Calyx Chairs & Stools.....CAL 1 - CAL 5
 Calyx Swivel and Swivel Tilt Chair.....CAL 6 - CAL 7
 Carver Chairs.....CAR 1
 D-Series Chairs.....DSE 1 - DSE 3
 Entice Chairs.....ENT 1 - ENT 2
 Essex Chairs.....ESS 1 - ESS 2
 Melis Chairs.....MEL 1 - MEL 2
 Metro Chairs.....MET 1
 Netta Chairs.....NET 1
 Parallax Chairs.....PAR 1 - PAR 2
 Pellego Chairs.....PEL 1
 Parallax Chairs.....PAR 1 - PAR 2

Lounge Furniture

Lounge.....Various

L1 Series.....L1S 1 - L1S 6
 L4 Series.....L4S 1 - L4S 2
 L5 Series.....L5S 1 - L5S 3
 LX Series.....LXS 1 - LXS 2
 Engage Series.....ENG 1 - ENG 2
 Cirro Soft Seating.....CIR 1 - CIR 3

Miscellaneous Furniture and Electrical

Cabinets (Base, Wall & Storage).....CAB 1 - CAB 8

Display Furniture.....DIS 1 - DIS 16

Wood Book Trucks.....WBT 1 - WBT 4

Electrical.....ELE 1 - ELE 16

General Specifications

Materials and Finishes, Quality Standards, and Performance Tests and Results



2017 Price List and Specifications Addendum

Brodart Co. Contract Furniture - Made in USA

280 North Road, Clinton County Industrial Park • McElhattan, PA 17748

Toll-Free: 888-521-1884 • E-Mail: furniture@brodart.com • www.brodartfurniture.com

General Information Brodart Contract Furniture

ORDERING INSTRUCTIONS

Your order can be entered and acknowledged promptly only if you supply us with certain essential information. A clean purchase order is needed to be entered into the manufacturing production process (Product Number, Quantity, Fabric, Finish, Species, Layouts, Photos, ect.). If any of these items are missing, your purchase order cannot be processed.

- a. Each item to be purchased must be identified by a complete catalog number.
- b. The quantity of each item to be purchased.
- c. If an item is modified in any way, the letters "MOD" must be used as a suffix on the catalog number.
- d. Unit price and extended price as determined from the Brodart price list, or a quotation from Brodart.
- e. If shop drawings are needed, note this requirement on your purchase order. You must supply architectural prints of pertinent building areas when requesting shop drawings.

Failure to supply essential order information may result in delays in the processing of your order.

TERMS AND CONDITIONS

Prices

These prices supersede all previously issued prices. All prices herein are list prices, unless otherwise noted, and are subject to change without notice. Prices stated are for our standard finishes, laminates, and materials. Any deviations from 'standard' are subject to an up charge. Up charges for specials will be quoted upon request.

Discounts

Discounts can be obtained by contacting a Project Coordinator. When obtaining discounts, you must be prepared to provide total list price information, estimated delivery dates, as well as all other information located on the *Discount Request Form*.

Payment Terms

Net 30 days from date of invoice, F.O.B. Factory

Taxes

Any sales or excise tax, or any other tax or government charge now or hereafter levied upon the product, sale, use or shipment of goods shall, at the Company's option, be charged to the customer.

Orders

All orders are subject to acceptance by Brodart Co., 280 North Road, Clinton County Industrial Park, McElhattan, PA 17748.

Acknowledgements

Brodart will ship products as detailed on the acknowledgement. Please confirm that all items are ordered as intended. Brodart will not accept responsibility for products shipped as acknowledged.

Cancellations

All orders are considered firm and cannot be cancelled without Brodart's approval. A cancellation charge will be required based on costs incurred. Minimum cancellation charge will be **\$50.00**

Order Changes

Changes to orders already in process are subject to a charge covering the making of the change. You will be required to indicate your acceptance of the additional costs before Brodart can proceed with the change. Minimum charge is **\$50.00**, other charges are as follows: Within 8 weeks of ship date - minimum charge is **\$150.00** plus any material costs incurred. Once the job is within 6 weeks and is in full production - minimum charge is **\$350.00** for the change and any material and labor costs involved. Brodart reserves the right to deny change requests within 6 weeks of the ship date.

All product ships from McElhattan, PA with the following exceptions:

Gondola Display Shelving Units:

For units ordered in quantities of 5 or less (or the only products on the order); units are shipped from 280 North Road with all other Furniture. For units ordered in quantities of 6 or more; product will ship direct from Columbus, Ohio.

Claims – Freight

All shipments are delivered to common carriers in good condition. Brodart's liability ceases once the order is delivered to the carrier. If your order is received short or damaged, you should note on your freight bill and file a claim immediately with the carrier.

Claims – Product

Claims against Brodart for defects, errors or shortages must be made by the purchaser, in writing, within 30 days after delivery. Failure to make such claim shall constitute full acceptance of the merchandise.

Returns

No Merchandise may be returned for credit without our previous agreement. Unauthorized returns will not be accepted.

Warranty

Brodart warrants that the Furniture designed and manufactured by it will be free of defects in material and workmanship for a period of twenty-five (25) years for furniture and five (5) years for seating. *Please refer to the official warranty documents for more information.*

Product Specifications

Product specifications are subject to change without notice.

Environmental

Brodart focuses on implementing environmental management practices that ensure our operations are conducted in a manner that respects, protects, and sustains the natural environment. For the most up-to-date information on Brodart's environmental policy including CARB, and more, please visit <http://www.brodartfurniture.com/about/environmental-efforts> or contact a Brodart Furniture representative.

Modified/Custom Products

Modifications in dimension, wood species, and design are available for an additional fee. Completely customized products are available as well on a per-project and per-quote basis. The following part numbers will be used based on the type of product:

CUSTOM	Custom Furniture	TABLEMOD	Custom Table
SHELVEMOD	Custom Shelving	COMPMOD	Custom Computer Furniture
LOUNGEMOD	Custom Lounge Furniture	CARRELMOD	Custom Carrels
HARDWAREMOD	Custom Hardware	CIRCMOD	Custom Circulation
DISPLAYMOD	Custom Display Units	CHAIRMOD	Custom Chair
REPRISEMOD	Custom Reprise	GEOMOD	Custom Geometrix

For any charges not listed in this Price List, please contact a Project Coordinator.

Product Options Brodart Contract Furniture

Antimicrobial Finish:

Brodart's finish now contains an antimicrobial agent formulated to resist mildew growth. This specially formulated finish prevents the growth and action of microbes from the degrading of Brodart Furniture and also helps to inhibit bacterial odors. **There is no up-charge for this additive.**

TABLE 1					
WOOD FINISH OPTIONS					
Oak Wood					
Clear On Oak	O33	Natural Oak	089	Antique on Oak	343
Porcelain on Oak	654	Solar on Oak	716	Victorian on Oak	790
Dark on Oak	801	Mocha on Oak	812	Champagne on Oak	837
Maple Wood					
Clear on Maple	M33	Natural Maple	089	Antique on Maple	343
Porcelain on Maple	654	Solar on Maple	716	Victorian on Maple	790
Dark on Maple	801	Mocha on Maple	812	Champagne on Maple	837
Cherry Wood					
Clear on Cherry	C33	Porcelain on Cherry	654		
Antique on Cherry	343	Victorian on Cherry	790		
Pigmented Stains (Formulated for Maple Wood, available on Oak Wood):					
Grasshopper	570	Pumpkin	515	Ginger	GNG
Storm	546	Fern	FRN	Mustard	MUS
Peaceful Blue	520	Cranberry	CRN	Sky	SKY
Dark Chocolate	580				

Finish Note: The wood finishes listed above are specifically formulated for the wood species listed. Color may vary significantly if the stain is used on a different species of wood. Color may vary on the same wood species due to grain and texture differences. Solid wood and matching veneer have distinct grain and color variations. Harmonious color variations will appear in each Brodart furniture piece.

Custom Finish: Custom finishes on orders over \$5,000.00 **NET** will not require a special finish fee. On orders under \$5,000.00 **NET**, one-step custom finishes are available at an up-charge of \$250.00 **NET** per color, per order. On orders where the finish is a multi-step or hand-wiped finish, a special up charge will be applied. Contact Brodart for a quotation.

HIGH-PRESSURE LAMINATES: WilsonArt laminates in finishes ending with "-60" and "-38" are preferred for Brodart Furniture. Up-charges for laminate that deviates from these are listed below. Please note that these selections may require a change in lead time as well. For an up-to-date listing of available WilsonArt Laminates, please visit: www.wilsonartcontract.com/.

TABLE 2		
Laminate Manufacturer & Type	Grade	Up-Charge
Wilsonart		
-60 and -38 Finishes	G1	0%
-01, -07, -18, -52, -78 Finishes	G2	3%
-35, -45, -55, and DeepStar Finishes	G3	12%
All Indie Collection	G5	45%
Pionite		
General Purpose Laminates	G2	3%
Specials	G3	12%
Nevamar		
All Laminate	G3	12%
Formica		
Patterns, Woodgrains, Solids, Dust & Graphix, Formations and Prime Colors (Grade 12, and 20 Matte)	G2	3%
Patterns, Woodgrains, Solids, Dust & Graphix, Formations and Prime Colors (Grade 12 Textured/Sparkle)	G3	12%
Etchings, Honed, Riverwash & Radiance (All Grades)	G3	12%
ColorCore and Chemtop	G5	45%
Marmoleum		
All	G4	20%

Alternatives to high-pressure laminate are available as well. If an alternative to high-pressure laminate (such as Corian) is desired, please refer to the "modifications" sections throughout this price list or contact your Project Coordinator for more information.

METAL OPTIONS (Powder Paint Guidelines & Up-Charges): Brodart's standard paint colors are available at no charge. Brodart "Select" colors are available at an up-charge of \$500.00 NET per color, per order. Custom powder paints are available as well; please call Brodart for pricing and availability.

TABLE 3					
METAL OPTIONS					
"Standard" Paint Options				"Select" Paint Options	
Sand	R3500051	Metallic Anthracite	R3500070	Yellow	R3500064
Almond	R3500057	Metallic Beige	R3500071	F/T* Blue	R3500098
Red	R3500052	Metallic Bengal Black	R3500095	F/T* Pale Yellow	R3500099
Blue	R3500060	Metallic Bengal Silver	R3500096	F/T* Red	R3500100
Gray	R3500053	Metallic Copper	R3500073		
Burgundy	R3500061			Metallic Sun Gold	R3500077
Hunter Green	R3500063	Nu Black Hammertone	R3500078	Metallic Bronze	R3500072
Brown	R3500055	Capri Blue Hammertone	R3500079	Metallic Gray	R3500074
Mango	R3500066	Antique White	R3500093		
Lilac	R3500067	Antique Gold	R3500091	Sapphire Hammertone	R3500087
Sapling	R3500068	Antique Silver	R3500092		
Olive	R3500069	Antique Copper	R3500090		
F/T* Black	R3500050				
F/T* Anthracite	R3500097			*FT = Fine Textured	
F/T* Bronze Mist	R3500065				

REPRISE SHELVING COLOR OPTIONS: Specify a color option for the the body and base shelf of shelving unit (Base Colors Only). Specify color option for shelves (Base Colors or Accent Colors for shelves).

TABLE 4			
BRODART STANDARD LAMINATES			
Accent Colors		Base Colors	
Orange	158	Canadian Gray	168
Red	201	Classic Maple	290
Plum	262	Classic Black	631
Island	375	White	143
Lapis Blue	5265	Biltmore Cherry	615
		Bannister Oak	519
		Pewter Mesh	823

FABRIC OPTIONS: Yardage requirements are listed under each product line. Yardages indicated in this price list are for non-directional 54" wide upholstery fabric. Additional yardage will be required if your upholstery fabric deviates in any way from "non-directional 54" wide".

TABLE 5	
FABRIC OPTIONS	
CFStinson or Douglass	www.brodartfurniture.com/products/custom-options/fabrics.asp
Cirro Vinyls	Use Zander vinyl from spradlingvinyl.com

Fabric Grade Information: Brodart offers fabrics in Grades 1-5 as listed in this price list. Fabrics can be selected from either CFStinson or Douglass via www.brodartfurniture.com/products/custom-options/fabrics.asp. Any fabrics listed on these sites as COM or coming from any other supplier must be handled as outlined in the "COM Fabrics" section of this price list.

California Technical Bulletin #133 treatment is available on all Crypton Upholstery at a charge of \$50.00/yard (list)

COM Fabrics: All fabrics sent to Brodart must be shipped PREPAID and tagged with the Project Name, Item Number, Sales Order Number (if available), and Project Manager's name. Ship to: *Brodart Co., 280 North Road, Clinton County Industrial Park, McElhattan, PA 17748 Attention: Furniture Marketing.*

Installation Hardware Kit: Full installation hardware kits are available upon request and include shelf pins, bolts, screws, washers, bushings, and brackets. For a complete list, please contact your Project Coordinator.

INSTHARDWARE

\$50.00 NET Per Kit

ACRYLICS: Standard Brodart Resin Offering. 1/4" thick, sandstone finish on both sides is the STANDARD. Variations may incur an up-charge.

TABLE 6	
RESIN OPTIONS	
Product	Colors
C3 (up to 3 layers)	Titanium, Sable, Marsh and Atlantic
Cirque	Silver
Linen	White
Regency	Silver
Struck	Cayenne, Jute and Kelp

Contact your designated Project Coordinator for ordering instructions.

Modifications & Up Charges



2017 Price List and Specifications

Brodart Co. Contract Furniture - Made in USA

280 North Road, Clinton County Industrial Park • McElhattan, PA 17748

Toll-Free: 888-521-1884 • E-Mail: furniture@brodart.com • www.brodartfurniture.com

Catalog No.	Description	Price
	Replace End Panels with Knee Space Panels To order, change S00 to MOD and insert "knee panel on (left or right)" to your description	\$109
	Removal of Grommet and Bushing Holes from and End Panel Per Panel	\$147
	Removal of Grommets from Work Surface Per Work Surface	\$177
	Cut Down in Dimension of a Open Unit (example: XX-014-S00) 1 Dimension Cut Down	\$177
	2 Dimension Cut Down	\$250
	3 Dimension Cut Down	\$353
	Cut Down in Dimension of a Cupboard/Drawer Unit (example: XX-121-S00) 1 Dimension Cut Down	\$353
	2 Dimension Cut Down	\$501
	3 Dimension Cut Down	\$647
	Change Work Surface Height (For Surface Between Panels Only) Per Unit	\$177
	Move A Box/File Drawer Left or Right Per Unit, specify location	\$182
	Factory Installed Add On Patron Ledge (Patron Ledge must be ordered separately) Single-Wide per Unit	\$324
	Double-Wide per Unit	\$401
	Add A Lock To A Drawer or Door Per Lock	\$132
	Key A Lock Differently from All Other Locks Per Lock	\$132
	Replace Standard Tops with Sup Tops Per Unit	\$177
	Place Continuous Tops on A Circulation Desk Unit Per Unit, Must use Sub Tops	\$104
	Change Standard Top/Edge Band to Corian Please send a Special Pricing Form to your Project Coordinator	SPECIAL PRICING

Catalog No.	Description	Price
Casters for Tables		
LG-CST-S00	Caster to Convert Table to be Mobile-Includes a Brake (Price is per leg)	\$84
MTCASTER	Caster to Convert M-Tables, Mobile Tables and Sync Tables Only (Price is per leg)	\$28
Cut Down in Dimension of Leg Base Tables*		
	1 Dimension Cut Down	\$177
	2 Dimension Cut Down	\$251
	Note: Dimension Cut Down pricing listed is for cuts on square and rectangular table ONLY. All others will require special pricing.	
Cut Down in Dimension of Apron/Panel Base Tables		
	1 Dimension Cut Down	\$324
	2 Dimension Cut Down	\$472
	Note: Dimension Cut Down pricing listed is for cuts on square and rectangular table ONLY. All others will require special pricing.	
Change 29"H Table to 32"H		\$153
	Note: Not available for mTables/Sync Tables/Mobile Tables	
Tapered Leg Option: Up-Charge		\$196
	Any Series Table.	
Change Standard Top/Edge Band to Corian		SPECIAL PRICING
	Please send a Special Pricing Form to your Project Coordinator.	
Add Grommets		SPECIAL PRICING
	Grommets can be added to all table sizes. Please specify the size of grommet (and location) and add the grommet list price to the table list price.	
Center Leg on 60"W to 72"W		SPECIAL PRICING
	Tables 60"W to 72"W will automatically receive a center leg for stability. Please contact your Project Coordinator for up-charge.	

Catalog No.	Description	Price
-------------	-------------	-------

****Accessories for Computer Furniture (example: Keyboard Trays & CPU Holders) can be found in the Circulation Desk Accessories Section page CIR 4.**

Casters for Computer Tables

LG-CST-S00	Caster to Convert Table to be Mobile-Includes a Brake (Price is per leg)	\$84
MTCASTER	Caster to Convert M-Tables Only (Price is per leg)	\$28

Cut Down in Dimension of Computer Tables without Privacy Panel

1 Dimension Cut Down	\$177
2 Dimension Cut Down	\$251

Note: Dimension Cut Down pricing listed is for cuts on square and rectangular table ONLY.
All others will require special pricing.

Cut Down in Dimension of Computer Tables with Privacy Panel

1 Dimension Cut Down	\$324
2 Dimension Cut Down	\$472

Note: Dimension Cut Down pricing listed is for cuts on square and rectangular table ONLY.
All others will require special pricing.

Cut Down in Dimension of any Workstations/Carrel Unit

Per Dimension, Per Unit	\$353
-------------------------	-------

Add an ADA Station to any Carrel Unit

Per Unit, Must Specify Location of Unit	\$279
---	-------

Change Standard Top/Edge Band to Corian

Please send a Special Pricing Form to your Project Coordinator.	SPECIAL PRICING
---	-----------------

Catalog No.	Description	Price
	Add Edge Band on back side of Single-Faced Continuous Tops	
	10% Per Continuous Top	10%
	Note: Charge is for adding the same style band that is on the unit.	
	Add Drop Edge Band to Continuous Tops	
	2% Per Continuous Top	2%
	Add Mitered Corners to Butt-Joint Series	
MOD	Per Continuous Top	\$266
	Change in Size of Continuous Tops	
	0% - Add 0" - 2"	0%
	10% - Add 2" - 4"	10%
	15% - Add 4" - 6"	15%
	Note: 0% for Reduction in Top Size.	0%
	Change Standard Top/Edge Band to Corian	
	Please send a Special Pricing Form to your Project Coordinator	SPECIAL PRICING
	Change in Size of End Panels	
	0% - Add 0" - 2"	0%
	10% - Add 2" - 4"	10%
	15% - Add 4" - 6"	15%
	Note: 0% for Reduction in Top Size.	0%

Modifications & Up Charges

Shelving

	Oak Catalog No.	Maple Catalog No.	Description	Wt. (lbs.)	Oak Price	Maple Price
Dust Covers (for use on high shelving) 1/4" Plywood, Cleats & Screws			Dust Covers (for use on high shelving) 1/4" Plywood, Cleats & Screws			
	SHELVMOD		Dust Cover for 10"D Unit	5	\$187	\$199
	SHELVMOD		Dust Cover for 12"D Unit	7	\$193	\$205
	SHELVMOD		Dust Cover for 16"D Unit	9	\$198	\$210
	SHELVMOD		Dust Cover for 20"D Unit	10	\$209	\$222
	SHELVMOD		Dust Cover for 24"D Unit	14	\$214	\$227
	SHELVMOD		Dust Cover for 32"D Unit	18	\$240	\$254

Shelving Modifications



Bullnose Fascia on Shelving Top

BNE
BNS
BNT
BNT



Fluted Fascia on Shelving Top

FT
FT



Dentil Fascia on Shelving Top

DT
DT

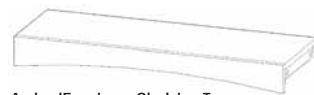

Arched Fascia on Shelving Top

AT
AT

SBS

Shelving Modifications

Bullnose End Panels, Add to Unit Price

Bullnose Shelves, Add to Unit Price

Bullnose Fascia on Shelving Top, Single-Faced

Bullnose Fascia on Shelving Top, Double-Faced

Fluted Fascia on Shelving Top, Single-Faced

Fluted Fascia on Shelving Top, Double-Faced

Dentil Fascia on Shelving Top, Single-Faced

Dentil Fascia on Shelving Top, Double-Faced

Arched Fascia on Shelving Top, Single-Faced

Arched Fascia on Shelving Top, Double-Faced

Sloping Base Shelving Option (per shelf)

Note: Sloping Base Shelf Price includes deletion of Standard Base Shelf.

14%

14%

5%

5%

\$65

\$68

\$136

\$143

\$65

\$68

\$136

\$143

\$65

\$68

\$136

\$143

\$65

\$68

\$136

\$143

\$44

\$46

Undersizing (Cut-Down)

MOD

MOD

MOD

MOD

MOD

MOD

Undersizing (Cut-Down)

Undersized Backs and Partitions (Specify Dimensions of Unit)

Cut-Down Height, Shelving Starter Unit Undersize Only

Cut-Down Height, Shelving Adder Unit Undersize Only

Cut-Down Width, Wood Shelving Unit, Undersize

Cut-Down Width, Omega or Omega Book Stop Shelving Unit, Undersize

Shelving Range Reducer Panel/Step Down Shelving
(S/F or D/F, LAYOUT - SKETCH REQUIRED)

\$25

N/A

\$98

N/A

\$60

N/A

\$219

N/A

\$416

N/A

\$444

N/A

Oversizing

MOD

MOD

Oversizing

Oversized Backs and Partitions up to 42"W

Oversized Width Shelving, Wood Only (Oversize to 42" MAX)

\$132

\$139

\$592

\$622



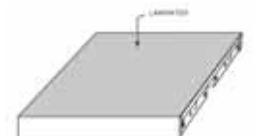

Note: Omega Shelving cannot be supplied oversized.

Oak Catalog No.	Maple Catalog No.	Description	Wt. (lbs.)	Oak Price	Maple Price
		Finish and Band Back Side of Shelving Unit (Backs Ordered Separately)			
					Finish and Band Back Side of Shelving Unit
MOD		Finish and Band Back Side of S/F Shelving Unit Starter		\$342	\$359
MOD		Finish and Band Back Side of S/F Shelving Unit Adder		\$253	\$266
		Convert Unit to Mobile (Price includes base facing, hardware and partition.)			
					Convert Unit to Mobile
MOD		Unit must be 60-1/2"H or less and a minimum of 20"D		\$1,300	\$1,300
		Filler Panel			
					Filler Panel
SHELVMOD		Plywood (per sq. ft. - Excluding Edge Banding)		\$30	\$32
SHELVMOD		Edge Banding, 1" x 1/4" (per lineal ft.)		\$6	\$6
SHELVMOD		Corner Filler Cap (per sq. ft.)		\$136	\$143
SHELVMOD		Corner Filler Cap with HPL (per sq. ft.)		\$156	\$164
		Deletion of Shelves			
					Deletion of Shelves
MOD		Deletion of 10" Wood Shelf (per shelf)		\$ -36	\$ -38
MOD		Deletion of 12" Wood Shelf (per shelf)		\$ -42	\$ -44
MOD		Deletion of 12" Picture Book Shelf (per shelf)		\$ -85	\$ -92
MOD		Deletion of 10" Omega Shelf (per shelf)		\$ -29	\$ -29
MOD		Deletion of 12" Omega Shelf (per shelf)		\$ -36	\$ -36
		Clip & Strip Shelving			
					10% Upcharge over standard shelving prices
					Clip & Strip Shelving
		<p>All shelving (with the exception of Glass Door Shelving) is listed as Pin & Hole construction. Clip & Strip shelving is available for Wood or Laminate Shelves ONLY and can be ordered by changing the S1 prefix on the starter unit to S3, and changing the S2 prefix on the adder unit to S4. Example: S3 861 S00 or S4 861 S00.</p>			
		Sub Tops for Shelving (to accept continuous HPL tops (sold separately) are available and can be ordered by changing the S00 extension on the catalog number to S02. Example: S1 861 S02.			
					Sub Tops for Shelving
		10", 12" and 16" Shelving Units with Sub Tops (list deduct per unit)		\$ -34	\$ -34
		20", 24" and 32" Shelving Units with Sub Tops (list deduct per unit)		\$ -67	\$ -67
		Individual HPL Tops for Shelving are available and can be ordered by changing the S00 extension on the catalog number to S03. Example: S1 861 S03.			
					Individual HPL Tops for Shelving
		10", 12" and 16" Individual HPL Tops (list add per unit)		\$64	\$64
		20", 24" and 32" Individual HPL Tops (list add per unit)		\$87	\$87

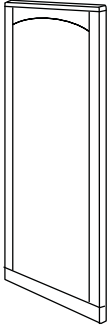

Modifications & Up Charges

Shelving

Panel Style	Description	Oak Price	Maple Price
 <p>Chancellor Panel</p>	<p>Panel Styles Up-charge is to be added to the STARTER UNIT price of the unit receiving the design. Any additional species/modification up-charges should be added over and above this charge.</p> <p>Upcharge for Chancellor Sketch Face Design - No Top Cap (per panel)</p>	62%	62%
 <p>Epoch Panel</p>	<p>Upcharge for Epoch with Painted Metal Inlay Design (per panel) Arched Top with 1/4" Painted Metal Inlay 4" from the bottom of the Panel. Note: Due to the arch on the Epoch series panels, if continuous tops are used, they MUST be inset (not overhang).</p> <p>Upcharge for Epoch with Chrome Metal Inlay Design (per panel) Arched Top with 1/4" Chrome Metal Inlay 4" from the bottom of the Panel. Note: Due to the arch on the Epoch series panels, if continuous tops are used, they MUST be inset (not overhang).</p>	9%	9%
 <p>Horizon Panel</p>	<p>Upcharge for Horizon Cut-Out with Laminate Inlay Design (per panel) With specified Cut-Outs and Laminate Inlay (overall panel thickness will be 1-1/4").</p>	81%	81%
 <p>Matrix Panel</p>	<p>Upcharge for Matrix Panel with Black Matrix Design Stencil (per panel)</p>	6%	6%

The Abridge Collection



2017 Price List and Specifications

Brodart Co. Contract Furniture - Made in USA

280 North Road, Clinton County Industrial Park • McElhattan, PA 17748

Toll-Free: 888-521-1884 • E-Mail: furniture@brodart.com • www.brodartfurniture.com

General Specifications

DESKTOP

Standard desktop is 1-3/16" thick, 3-ply, 45# density particleboard core, with a high-pressure laminate top surface .050" thick and a backing sheet .020" thick for balanced construction. The desk top receives a solid Northern-grown Red Oak or maple flush edge band 5/8" x 1-3/16" thick, radiused 1/2" to form a waterfall shape on the patron side. A 1/4", solid Northern-grown Red Oak or maple edge band is applied to the remaining three sides of the desk top, with top and bottom edges have a 1/8" radius. All edges are applied to the desktop after the laminate and backer sheets are applied, constituting an external edge band. Desktop is positioned over the end panels of the desk module, flush with the outside edges of the end panels.

END PANEL

Desk module end panel is 1" thick, 3-ply, 45# density particleboard core with select plain-sliced slip matched Northern-grown Red Oak or maple veneer on both sides. Exposed edges are externally banded with a 1" x 1.6mm thick Northern-grown Red Oak or maple veneer edge band. The end panel and front panel are joined with 3/4" x 3/4" thick solid hardwood cleats screwed to the inside surface of the panel. Each end panel receives a 3" diameter egress grommet to provide for wire passage and two adjustable glides to allow leveling of the individual units.

FRONT PANEL

The front panel is 3/4" thick; 45# density particleboard core comprised of select rift cut Northern-grown Red Oak veneers or maple plain sliced slip matched veneers. Exposed edges are externally banded with a 3/4" x 1.6mm thick, veneer edge band. A 6"H x 3/4"D recessed, ebonized, toe space is incorporated at the bottom of the panel. The front panel is positioned over the end panels of the desk module, flush with the outside edges of the end panels. Double wide units have two front panels to give the appearance of two individual units.

DESK DIMENSIONS

Standing-Height Desk, overall:

39-3/16"H x 35"W x 30"D or 39-3/16"H x 70"W x 30"D.

Sitting-Height Desk, overall:

32-3/16"H x 35"W x 30"D or 32-3/16"H x 70"W x 30"D.

WORK SURFACE

Work surface is 1-3/16" thick, 3-ply, 45# density particleboard core, with a high-pressure laminate top surface .050" thick and a backing sheet .020" thick for balanced construction. The exposed edge receives a 1/4" thick, Northern-grown Red Oak or maple solid internal edge band in straight design. The back edge of the work surface has a plastic black strip, 1-1/2"W, which projects above the work surface 1/4" to act as a retainer. The work surface is 24-1/2"D and is positioned 1-1/2" away from the front panel, creating a cord drop space. Adjustable work surfaces positioned at heights of 36", 32" or 27" are available in single wide standing height desks.

Note: See Brodart optional electrical accessories for electrical power-distribution system for desk modules.

SHELVES

Shelves are constructed of 7-ply, furniture-grade veneer-core hardwood plywood, with Northern-grown Red Oak plain sliced face veneer or maple plain sliced face veneer. Exposed edges receive a 1.6mm thick, solid-oak or maple edge band.

DRAWER

Drawer is constructed of solid Northern-grown Red Oak or maple with 1/4" thick wood bottom panel. Drawer has 3-ply particleboard fronts with select oak-face veneer or maple veneer. Box drawer has extension slides with 100# load capacity. File drawer has full-extension slides with 100# load capacity. Double Units: 32-3/16"H x 70"W x 30"D

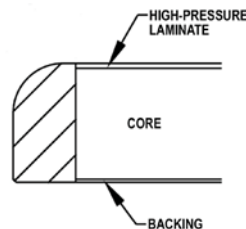



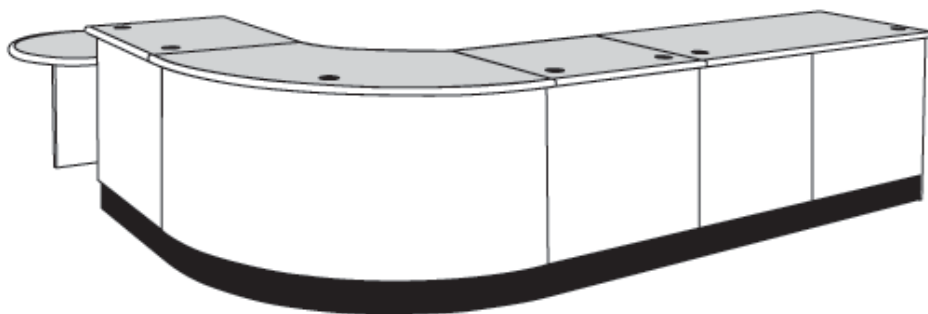

Abridge Flush Edge Band







Oak Catalog No.	Maple Catalog No.	Description	H x W x D	Wt. (lbs.)	Oak Price	Maple Price	Standing	Sitting
ABOCIRSW39PLS	ABMCIRSW39PLS	Standing Height Desk with Patron Service Ledge Inside dimensions: 33"W x 26-3/4"D. The 7-7/8" patron ledge is at a height of 39-1/4"H. Note: Adjustable-height work surface may be positioned at heights of 36", 32" or 27".	39-3/16" x 35" x 30"	140	\$2,654	\$2,893	Single-Wide Desk with Patron Service Ledge	
ABOCIRSW32PLS	ABMCIRSW32PLS	Sitting Height Desk with Patron Service Ledge Inside dimensions: 33"W x 26-3/4"D. The 7-7/8" patron ledge is at a height of 32-3/16"H. Note: Work surface is fixed at 27"H.	32-3/16" x 35" x 30"	125	\$2,522	\$2,748	Single-Wide Desk with Patron Service Ledge	
ABOCIRSW39S	ABMCIRSW39S	Standing Height Desk without Patron Service Ledge Inside dimensions: 33"W x 26-3/4"D. The work surface is at 39-3/16"H. Two 3" diameter grommets are located in the work surface.	39-3/16" x 35" x 30"	135	\$2,317	\$2,525	Single-Wide Desk without Patron Service Ledge	
ABOCIRSW32S	ABMCIRSW32S	Sitting Height Desk without Patron Service Ledge Inside dimensions: 33"W x 26-3/4"D. The work surface is at 32-3/16"H. Two 3" diameter grommets are located in the work surface.	32-3/16" x 35" x 30"	120	\$2,122	\$2,313	Single-Wide Desk without Patron Service Ledge	
ABOCIRSW39BRS	ABMCIRSW39BRS	Standing Height Book Return Unit Inside dimensions: 33"W x 26-3/4"D. The work surface is at 39-3/16"H. Unit has a 5"H x 12"W finished opening centered in the front panel for passage of books and a book chute to direct the books over a mobile depressible book truck. (Depressible book truck not included). Two 3" diameter grommets are located in the work surface.	39-3/16" x 35" x 30"	135	\$2,246	\$2,448	Book Return Unit	
ABOCIRSW32BRS	ABMCIRSW32BRS	Sitting Height Book Return Unit Inside dimensions: 33"W x 26-3/4"D. The work surface is at 32-3/16"H. Unit has a 5"H x 12"W finished opening centered in the front panel for passage of books and a book chute to direct the books over a mobile depressible book truck. (Depressible book truck not included). Two 3" diameter grommets are located in the work surface.	32-3/16" x 35" x 30"	120	\$2,114	\$2,305	Book Return Unit	

Please specify Wood Finish (Table 1) and High-Pressure Laminate (Table 2). Details can be found on page GEN 4.

Standing	Sitting	Oak Catalog No.	Maple Catalog No.	Description	H x W x D	Wt. (lbs.)	Oak Price	Maple Price
Cupboard and Open Shelf		ABOCIRSW39COSS	ABMCIRSW39COSS	Standing Height Cupboard and Open Shelf	39-3/16" x 35" x 30"	175	\$4,415	\$4,813
				This unit has one fixed and two adjustable shelves. A hidden drawer is positioned above the lockable storage compartment. Two 3" diameter grommets are located in the work surface.				
		ABOCIRSW32COSS	ABMCIRSW32COSS	Sitting Height Cupboard	32-3/16" x 35" x 30"	160	\$4,127	\$4,498
				This unit has one fixed and one adjustable shelf. A hidden drawer is positioned above the lockable storage compartment. Two 3" diameter grommets are located in the work surface.				
Full Width Drawer, Cupboard and Drawers		ABOCIRSW39FCDS	ABMCIRSW39FCDS	Standing Height Full Width Drawer, Cupboard and Drawers	39-3/16" x 35" x 30"	225	\$6,048	\$6,593
				This unit has one full-width drawer, two file drawers, and a lockable storage compartment. Two 3" diameter grommets are located in the work surface. Note: Available in 39"H only.				
Cupboard and Drawer Unit		ABOCIRSW39CDS	ABMCIRSW39CDS	Standing Height Cupboard and Drawer Unit	39-3/16" x 35" x 30"	225	\$5,355	\$5,837
				This unit has one locking box drawer and two file drawers. Cupboard section has two adjustable shelves and locking door on hinges. Two 3" diameter grommets are located in the work surface.				
		ABOCIRSW32CDS	ABMCIRSW32CDS	Sitting Height Cupboard and Drawer Unit	32-3/16" x 35" x 30"	205	\$4,878	\$5,316
				This unit has one locking file drawer and one file drawer. Cupboard section has one adjustable shelf and locking door on hinges. Two 3" diameter grommets are located in the work surface.				

Please specify Wood Finish (Table 1) and High-Pressure Laminate (Table 2). Details can be found on page GEN 4.

Oak Catalog No.	Maple Catalog No.	Description	H x W x D	Wt. (lbs.)	Oak Price	Maple Price	Standing	Sitting
ABOCIRSW39OSDS	ABMCIRSW39OSDS	Standing Height Open Shelf and Drawer Unit This unit has one lockable box drawer and two file drawers. Shelf section has two adjustable shelves, and one fixed base shelf. Two 3" diameter grommets are located in the work surface.	39-3/16" x 35" x 30"	200	\$4,942	\$5,387	Open Shelf and Drawer Unit	
								
ABOCIRSW32OSDS	ABMCIRSW32OSDS	Sitting Height Open Shelf and Drawer Unit This unit has one lockable box drawer and one file drawer. Shelf section has one adjustable shelf, and one fixed base shelf. Two 3" diameter grommets are located in the work surface.	32-3/16" x 35" x 30"	180	\$4,510	\$4,916		
								
ABOCIRSW39CSDS	ABMCIRSW39CSDS	Standing Height Cash Drawer Unit Inside dimensions: 33"W x 26-3/4"D. The work surface is at 39-3/16"H. Desk has locking drawer with a coin and currency tray. Two 3" diameter grommets are located in the work surface.	39-3/16" x 35" x 30"	150	\$3,359	\$3,662	Cash Drawer Unit	
								
ABOCIRSW32CSDS	ABMCIRSW32CSDS	Sitting Height Cash Drawer Unit Inside dimensions: 33"W x 26-3/4"D. The work surface is at 32-3/16"H. Desk has locking drawer with a coin and currency tray. Two 3" diameter grommets are located in the work surface.	32-3/16" x 35" x 30"	135	\$3,216	\$3,505		
								
ABOCIRSW32ADAS	ABMCIRSW32ADAS	Sitting Height ADA Station The ADA transaction station is designed to provide wheelchair access on the patrons' side. The knee space depth on the patrons' side is 22-1/4" and on the staff side is 16". Two 3" diameter grommets are located in the work surface. One 3-1/2" diameter egress with sleeve is located in each end panel for wire passage.	32-3/16" x 35" x 30"	185	\$2,522	\$2,748	ADA Station	
								

Please specify Wood Finish (Table 1) and High-Pressure Laminate (Table 2). Details can be found on page GEN 4.

Standing	Sitting	Oak Catalog No.	Maple Catalog No.	Description	H x W x D	Wt. (lbs.)	Oak Price	Maple Price
----------	---------	--------------------	----------------------	-------------	-----------	---------------	--------------	----------------



Full Width Drawer Unit		ABOCIRSW39FS	ABMCIRSW39FS	Standing Height Full Width Drawer Unit	39-3/16" x 35" x 30"	160	\$3,455	\$3,765
------------------------	--	--------------	--------------	--	----------------------	-----	---------	---------

This drawer unit has a full-width drawer 10"H x 33"W x 18-3/4"D. Two 3" diameter grommets are located in the work surface.
Note: Available in 39" H only.

Full Width Drawer and Cupboard Unit



Full Width Drawer and Cupboard Unit		ABOCIRSW39FCS	ABMCIRSW39FCS	Standing Height Full Width Drawer and Cupboard Unit	39-3/16" x 35" x 30"	220	\$3,841	\$4,187
-------------------------------------	--	---------------	---------------	---	----------------------	-----	---------	---------

This unit has a full-width drawer 10"H x 33"W x 18-3/4"D. Also, one fixed and one adjustable, full-depth shelf. Hinged doors have a catch, lock and door pulls. Two 3" diameter grommets are located in the work surface.

Discharge Unit



Discharge Unit		ABOCIRSW39DS	ABMCIRSW39DS	Standing Height Discharge Unit	39-3/16" x 35" x 30"	165	\$3,612	\$3,937
----------------	--	--------------	--------------	--------------------------------	----------------------	-----	---------	---------







These units have a full-width well with seven removable wood trays for 5"H x 3"W cards. The 7-7/8" patron ledge is at a height of 39-3/16"H.
Note: Standing-height roll unders do not work with this unit.



		ABOCIRSW32DS	ABMCIRSW32DS	Sitting Height Discharge Unit	32-3/16" x 35" x 30"	145	\$3,418	\$3,725
--	--	--------------	--------------	-------------------------------	----------------------	-----	---------	---------

These units have a full-width well with seven removable wood trays for 5"H x 3"W cards. The 7-7/8" patron ledge is at a height of 32-3/16"H.

Please specify Wood Finish (Table 1) and High-Pressure Laminate (Table 2). Details can be found on page GEN 4.





Oak Catalog No.	Maple Catalog No.	Description	H x W x D	Wt. (lbs.)	Oak Price	Maple Price	Standing	Sitting
ABOCIRSW39OSS	ABMCIRSW39OSS	Standing Height Open Shelf Unit This unit has a full-depth fixed base shelf and two full-depth adjustable shelves. Two 3" diameter grommets are located in the work surface.	39-3/16" x 35" x 30"	175	\$2,689	\$2,931		Open Shelf Unit
ABOCIRSW32OSS	ABMCIRSW32OSS	Sitting Height Open Shelf Unit This unit has a full-depth fixed base shelf and two full-depth adjustable shelves. Two 3" diameter grommets are located in the work surface.	32-3/16" x 35" x 30"	155	\$2,400	\$2,616		
ABOCIRSW39CS	ABMCIRSW39CS	Standing Height Cupboard Unit This unit has a full-depth fixed base shelf and two full-depth adjustable shelves. Hinged doors have a catch, lock and door pulls. Two 3" diameter grommets are located in the work surface.	39-3/16" x 35" x 30"	200	\$3,340	\$3,640		Cupboard Unit
ABOCIRSW32CS	ABMCIRSW32CS	Sitting Height Cupboard Unit This unit has a full-depth fixed base shelf and one full-depth adjustable shelf. Hinged doors have a catch, lock and door pulls. Two 3" diameter grommets are located in the work surface.	32-3/16" x 35" x 30"	180	\$3,187	\$3,474		
ABOCIRSW39FOSS	ABMCIRSW39FOSS	Standing Height Full Width Drawer and Open Shelves This unit has a full-width drawer 10"H x 33"W x 18-3/4"D. Also, one fixed and one adjustable, full-depth shelf. Two 3" diameter grommets are located in the work surface.	39-3/16" x 35" x 30"	180	\$3,264	\$3,558		Full Width Drawer and Open Shelves
ABOCIRSW32FOSS	ABMCIRSW32FOSS	Sitting Height Full Width Drawer and Open Shelves This unit has a full-width drawer 10"H x 33"W x 18-3/4"D. Also, one fixed and one adjustable, full-depth shelf. Two 3" diameter grommets are located in the work surface.	32-3/16" x 35" x 30"	165	\$3,072	\$3,349		

Please specify Wood Finish (Table 1) and High-Pressure Laminate (Table 2). Details can be found on page GEN 4.

Standing	Sitting	Oak Catalog No.	Maple Catalog No.	Description	H x W x D	Wt. (lbs.)	Oak Price	Maple Price
		ABOCIRSW39MSS	ABMCIRSW39MSS	Standing Height Media Storage Unit This unit has four full-width drawers 8-1/2"H x 33"W x 24"D with each containing five compartments for media storage.	39-3/16" x 35" x 30"	225	\$4,613	\$5,028
		ABOCIRSW32MSS	ABMCIRSW32MSS	Sitting Height Media Storage Unit This unit has three full-width drawers 8-1/2"H x 33"W x 24"D with each containing five compartments for media storage.	32-3/16" x 35" x 30"	205	\$4,240	\$4,621



Please specify Wood Finish (Table 1) and High-Pressure Laminate (Table 2). Details can be found on page GEN 4.

Oak Catalog No.	Maple Catalog No.	Description	H x W x D	Wt. (lbs.)	Oak Price	Maple Price	Standing	Sitting
ABOCIRDW39PL35S	ABMCIRDW39PL35S	Standing Height Double-Wide Desk with Patron Service Ledge Work Surface at 35"H Inside dimensions are 68"W x 26-3/4"D. The 7-7/8"D patron ledge is at a height of 39-3/16". Two 3" diameter grommets are located in the work surface. Note: Standing-height roll unders do not work with this unit.	39-3/16" x 70" x 30"	245	\$3,839	\$4,185		Double-Wide Desk with Patron Service Ledge,
								
ABOCIRDW32PLS	ABMCIRDW32PLS	Sitting Height Double-Wide Desk with Patron Service Ledge Work Surface at 28"H Inside dimensions are 68"W x 26-3/4"D. The 7-7/8"D patron ledge is at a height of 32-3/16". Two 3" diameter grommets are located in the work surface.	32-3/16" x 70" x 30"	210	\$3,621	\$3,947		
								
ABOCIRDW39PL28S	ABMCIRDW39PL28S	Standing Height Double-Wide Desk with Patron Service Ledge Work Surface at 28"H Inside dimensions are 68"W x 26-3/4"D. The 7-7/8"D patron ledge is at a height of 39-3/16". Two 3" diameter grommets are located in the work surface. Note: Standing-height roll unders do not work with this unit.	39-3/16" x 70" x 30"	245	\$3,742	\$4,079		
								
ABOCIRDW39S	ABMCIRDW39S	Standing Height Double-Wide Desk without Patron Service Ledge Inside dimensions are 68"W x 26-3/4"D. The work surface is at 39-3/16" H. Two 3" diameter grommets are located in the work surface.	39-3/16" x 70" x 30"	230	\$3,411	\$3,717		Double-Wide Desk without Patron Service Ledge
								
ABOCIRDW32S	ABMCIRDW32S	Sitting Height Double-Wide Desk without Patron Service Ledge Inside dimensions are 68"W x 26-3/4"D. The work surface is at 32-3/16" H. Two 3" diameter grommets are located in the work surface.	32-3/16" x 70" x 30"	195	\$3,240	\$3,532		
								

Please specify Wood Finish (Table 1) and High-Pressure Laminate (Table 2). Details can be found on page GEN 4.

Standing	Sitting	Oak Catalog No.	Maple Catalog No.	Description	H x W x D	Wt. (lbs.)	Oak Price	Maple Price
Double-Wide	Double Pedestal	ABOCIRDW32DPS	ABMCIRDW32DPS	Sitting Height Double-Wide Double Pedestal Work Desk	32-3/16" x 70" x 30"	260	\$7,872	\$8,580



Inside dimensions are 68"W x 26-3/4"D.
 This unit has two drawer pedestals, one mounted on each side consisting of one locking drawer at top; one file drawer with hanging file rack at bottom. Two center drawers are mounted between the two pedestals. Two 3" diameter grommets are located in the work surface.
Note: Available in 32-3/16" H only.

Double-Wide	Single Pedestal	ABOCIRDW39SPS	ABMCIRDW39SPS	Standing Height Double-Wide Single Pedestal Work Desk	39-3/16" x 70" x 30"	230	\$5,183	\$5,650
-------------	-----------------	---------------	---------------	---	----------------------	-----	---------	---------









Inside dimensions are 68"W x 26-3/4"D.
 This unit has one drawer pedestal mounted on the left side consisting of one locking drawer at top; two file drawers with Pendaflex hangers at the bottom. Two 3" diameter grommets are located in the work surface.

		ABOCIRDW32SPS	ABMCIRDW32SPS	Sitting Height Double-Wide Single Pedestal Work Desk	32-3/16" x 70" x 30"	195	\$4,896	\$5,337
--	--	---------------	---------------	--	----------------------	-----	---------	---------









Inside dimensions are 68"W x 26-3/4"D.
 This unit has one drawer pedestal mounted on the left side consisting of one locking file drawer at top; one file drawer at the bottom, both with hanging file racks. Two 3" diameter grommets are located in the work surface.





Please specify Wood Finish (Table 1) and High-Pressure Laminate (Table 2). Details can be found on page GEN 4.

Oak Catalog No.	Maple Catalog No.	Description	H x W x D	Wt. (lbs.)	Oak Price	Maple Price	Standing	Sitting
ABOCIR9039MCS	ABMCIR9039MCS	Standing Height 90 Degree Multi-Purpose Corner Unit has 29-5/16"W port area. Storage shelves are located in the two angled areas to the left and right of the desk module. One 3" diameter grommet is located in the work-surface top. One 3-1/2" diameter egress with sleeve is located in each end panel for wire passage.	39-3/16" x 71-3/4" x 30"	250	\$5,013	\$5,464		90 Degree Multi-Purpose Corner
								
ABOCIR9032MCS	ABMCIR9032MCS	Sitting Height 90 Degree Multi-Purpose Corner Unit has 29-5/16"W port area. Storage shelves are located in the two angled areas to the left and right of the desk module. One 3" diameter grommet is located in the work-surface top. One 3-1/2" diameter egress with sleeve is located in each end panel for wire passage.	32-3/16" x 71-3/4" x 30"	215	\$4,797	\$5,228		
								
ABOCIR9039MCPS	ABMCIR9039MCPS	Standing Height 90 Degree Multi-Purpose with Patron Service Ledge Unit has 29-5/16"W port area. The 7-7/8"D patron ledge is at a height of 39-3/16". Work surface is at 35"H. Storage shelves are located in the two angled areas to the left and right of the module. One 3" diameter grommet is located in the work surface top. One 3-1/2" diameter egress with sleeve is located in each end panel for wire passage.	39-3/16" x 71-3/4" x 30"	245	\$6,513	\$7,099		90 Degree Multi-Purpose Corner with Patron Service Ledge
								
ABOCIR9032MCPS	ABMCIR9032MCPS	Sitting Height 90 Degree Multi-Purpose with Patron Service Ledge Unit has 29-5/16"W port area. The 7-7/8"D patron ledge is at a height of 32-3/16". Work surface is at 28"H. Storage shelves are located in the two angled areas to the left and right of the module. One 3" diameter grommet is located in the work surface top. One 3-1/2" diameter egress with sleeve is located in each end panel for wire passage.	32-3/16" x 71-3/4" x 30"	210	\$6,239	\$6,801		
								
ABOCIR9039CCS	ABMCIR9039CCS	Standing Height 90 Degree Closed Corner Unit This 90 degree unit is used to form a right angle turn in a desk arrangement. This is not available with patron ledge. One 3-1/2" diameter egress is located in each end panel for wire passage through a continuous ABS tube.	39-3/16"H	140	\$2,680	\$2,921		90 Degree Closed Corner Unit
								
ABOCIR9032CCS	ABMCIR9032CCS	Sitting Height 90 Degree Closed Corner Unit This 90 degree unit is used to form a right angle turn in a desk arrangement. This is not available with patron ledge. One 3-1/2" diameter egress is located in each end panel for wire passage through a continuous ABS tube.	32-3/16"H	120	\$2,550	\$2,779		
								

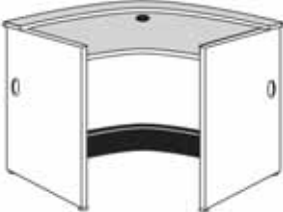

Please specify Wood Finish (Table 1) and High-Pressure Laminate (Table 2). Details can be found on page GEN 4.

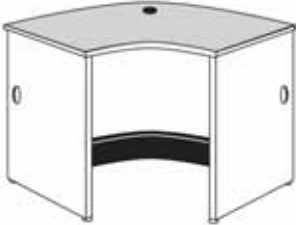
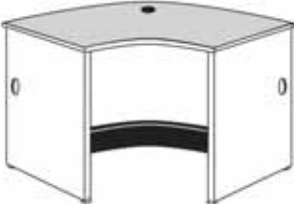
Standing	Sitting	Oak Catalog No.	Maple Catalog No.	Description	H x W x D	Wt. (lbs.)	Oak Price	Maple Price
		ABOCIR4539CCS	ABMCIR4539CCS	Standing Height 45 Degree Closed Corner Unit	39-3/16" x 22-7/8" x 30"	130	\$2,490	\$2,715
				This corner unit is used to create a 45 degree angle in the circulation desk. This unit is not available with a patron ledge.				
		ABOCIR4532CCS	ABMCIR4532CCS	Sitting Height 45 Degree Closed Corner Unit	32-3/16" x 22-7/8" x 30"	110	\$2,358	\$2,570
				This corner unit is used to create a 45 degree angle in the circulation desk. This unit is not available with a patron ledge.				
		ABOCIR90390CCPS	ABMCIR90390CCPS	Standing Height 90 Degree Open Curved Corner with Patron Service Ledge	39-3/16" x 70-1/8" x 30"	245	\$8,125	\$8,856
				The 7-7/8"D patron ledge is at a height of 39-3/16". The work surface is at 35"H. Unit has 26-5/8"W port area. Storage shelves are located in the two angled areas to the left and right of the desk module. One 3" diameter grommet is located in the work surface top. One 3-12" diameter egress with sleeve is located in each end panel for wire passage.				
		ABOCIR90320CCPS	ABMCIR90320CCPS	Sitting Height 90 Degree Open Curved Corner with Patron Service Ledge	32-3/16" x 70-1/8" x 30"	210	\$7,829	\$8,533
				The 7-7/8"D patron ledge is at a height of 32-3/16". The work surface is at 35"H. Unit has 26-5/8"W port area. Storage shelves are located in the two angled areas to the left and right of the desk module. One 3" diameter grommet is located in the work surface top. One 3-12" diameter egress with sleeve is located in each end panel for wire passage.				
		ABOCIR90390CCS	ABMCIR90390CCS	Standing Height 90 Degree Open Curved Corner	39-3/16" x 70-1/8" x 30"	245	\$7,165	\$7,809
				Work surface is at 39-3/16"H. Unit has 26-5/8"W port area. Storage shelves are located in the two angled areas to the left and right of the desk module. One 3" diameter grommet is located in the work-surface top. One 3-1/2" diameter egress with sleeve is located in each end panel for wire passage.				
		ABOCIR90320CCS	ABMCIR90320CCS	Sitting Height 90 Degree Open Curved Corner	32-3/16" x 70-1/8" x 30"	210	\$6,899	\$7,520
				Work surface is at 32-3/16"H. Unit has 26-5/8"W port area. Storage shelves are located in the two angled areas to the left and right of the desk module. One 3" diameter grommet is located in the work-surface top. One 3-1/2" diameter egress with sleeve is located in each end panel for wire passage.				



Please specify Wood Finish (Table 1) and High-Pressure Laminate (Table 2). Details can be found on page GEN 4.

Oak Catalog No.	Maple Catalog No.	Description	H x W x D	Wt. (lbs.)	Oak Price	Maple Price	Standing	Sitting
ABOCIR6039CCPS	ABMCIR6039CCPS	Standing Height 60 Degree Curved Corner with Patron Service Ledge The 7-7/8"D patron ledge is at a height of 39-3/16". The work surface is at 35-7/16"H. Unit has 49-1/16" W port area. Storage shelves are located in the two angled areas to the left and right of the desk module. One 3" diameter grommet is located in the work surface top. One 3-1/2" diameter egress with sleeve is located in each end panel for wire passage.	39-3/16" x 80-3/4" x 30"	245	\$9,785	\$10,665		60 Degree Curved Corner with Patron Service Ledge
								
ABOCIR6032CCPS	ABMCIR6032CCPS	Sitting Height 60 Degree Curved Corner with Patron Service Ledge The 7-7/8"D patron ledge is at a height of 32-3/16". The work surface is at 28"H. Unit has 49-1/16" W port area. Storage shelves are located in the two angled areas to the left and right of the desk module. One 3" diameter grommet is located in the work surface top. One 3-1/2" diameter egress with sleeve is located in each end panel for wire passage.	32-3/16" x 80-3/4" x 30"	210	\$9,434	\$10,283		
								
ABOCIR6039CCS	ABMCIR6039CCS	Standing Height 60 Degree Curved Corner Work surface is at 39-3/16"H. Unit has 49-1/16"W port area. Storage shelves are located in the two angled areas to the left and right of the desk module. One 3" diameter grommet is located in the work surface top. One 3-1/2" diameter egress with sleeve is located in each end panel for wire passage.	39-3/16" x 80-3/4" x 30"	245	\$8,843	\$9,638		60 Degree Curved Corner
								
ABOCIR6032CCS	ABMCIR6032CCS	Sitting Height 60 Degree Curved Corner Work surface is at 32-3/16"H. Unit has 49-1/16"W port area. Storage shelves are located in the two angled areas to the left and right of the desk module. One 3" diameter grommet is located in the work surface top. One 3-1/2" diameter egress with sleeve is located in each end panel for wire passage.	32-3/16" x 80-3/4" x 30"	210	\$8,533	\$9,301		
								
ABOCIR9039CCCS	ABMCIR9039CCCS	Standing Height 90 Degree Closed Corner Unit This 90 degree unit is used to form a right-angle turn in a desk arrangement. This unit is provided with a curved front panel.	39-3/16"H x 30"D	140	\$3,464	\$3,776		90 Degree Curved Closed Corner Unit
								
ABOCIR9032CCCS	ABMCIR9032CCCS	Sitting Height 90 Degree Closed Corner Unit This 90 degree unit is used to form a right-angle turn in a desk arrangement. This unit is provided with a curved front panel.	32-3/16"H x 30"D	120	\$3,236	\$3,527		
								

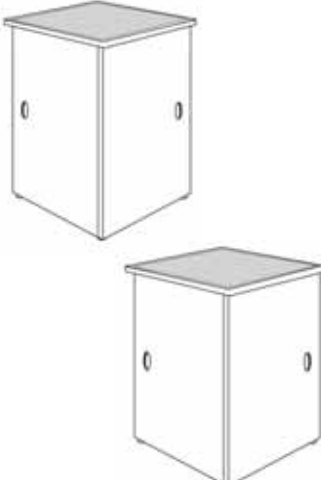
Please specify Wood Finish (Table 1) and High-Pressure Laminate (Table 2). Details can be found on page GEN 4.

Standing	Sitting	Oak Catalog No.	Maple Catalog No.	Description	H x W x D	Wt. (lbs.)	Oak Price	Maple Price
		ABOCIR4539CCCS	ABMCIR4539CCCS	Standing Height 45 Degree Curved Closed Corner Unit This unit is used to create a 45 degree angle in the circulation desk. It is not available with patron ledge.	39-3/16" x 22-3/8" x 30"	130	\$3,167	\$3,452
		ABOCIR4532CCCS	ABMCIR4532CCCS	Sitting Height 45 Degree Curved Closed Corner Unit This unit is used to create a 45 degree angle in the circulation desk. It is not available with patron ledge.	32-3/16" x 22-3/8" x 30"	110	\$2,938	\$3,203
		ABOCIR9039OCSS	ABMCIR9039OCSS	Standing Height 90 Degree Open Corner Shelf This 90 degree unit is used to form a right-angle turn in a desk arrangement. Has one fixed base shelf and two adjustable shelves. Note: Units must be modified on a project by project basis for electrical pass-through on open corner units.	39-3/16"H x 30"D	140	\$2,464	\$2,686
		ABOCIR9032OCSS	ABMCIR9032OCSS	Sitting Height 90 Degree Open Corner Shelf This 90 degree unit is used to form a right-angle turn in a desk arrangement. Has one fixed base shelf and two adjustable shelves. Note: Units must be modified on a project by project basis for electrical pass-through on open corner units.	32-3/16"H x 30"D	120	\$2,281	\$2,486
		ABOCIR9039SCS	ABMCIR9039SCS	Standing Height 90 Degree Square Corner Unit This square corner unit is used to form a right angle in a desk arrangement. One 3" diameter egress is located in each end panel for wire passage through a continuous ABS tube.	39-3/16" x 30" x 30"	160	\$2,667	\$2,906
		ABOCIR9032SCS	ABMCIR9032SCS	Sitting Height 90 Degree Square Corner Unit This square corner unit is used to form a right angle in a desk arrangement. One 3" diameter egress is located in each end panel for wire passage through a continuous ABS tube.	32-3/16" x 30" x 30"	140	\$2,514	\$2,740

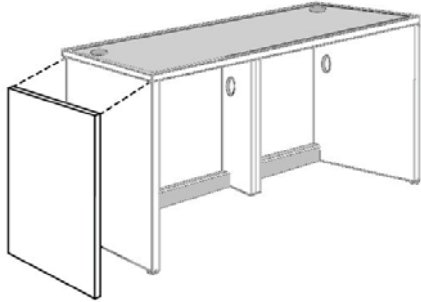
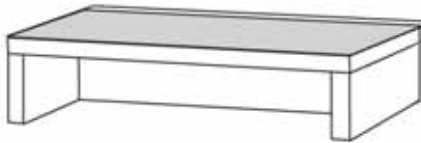
Please specify Wood Finish (Table 1) and High-Pressure Laminate (Table 2). Details can be found on page GEN 4.

Oak Catalog No.	Maple Catalog No.	Description	H x W x D	Wt. (lbs.)	Oak Price	Maple Price	
ABOCIREP39S	ABMCIREP39S	Detachable End Panels (Pair) End panels are 1" thick, 3-ply, 45# density particleboard core with plain-sliced oak or maple veneers. Exposed edges are externally banded with 1.6mm thick, solid Northern-grown Oak or maple edge band.	37-1/2" x 1" x 26-3/4"	52	\$1,027	\$1,119	Detachable End Panels (Pair) 
ABOCIREP32S	ABMCIREP32S	Detachable End Panels (Pair) End panels are 1" thick, 3-ply, 45# density particleboard core with plain-sliced oak or maple veneers. Exposed edges are externally banded with 1.6mm thick, solid Northern-grown Oak or maple edge band.	30-1/2" x 1" x 26-3/4"	42	\$980	\$1,068	
ABOCIRSWPL7HS	ABMCIRSWPL7HS	Single-Wide Add On 7"H Patron Ledge Unit is designed to be added onto a single wide desk without a patron ledge. The Patron Ledge Assembly will attach to the desktop by means of #8 x 2-1/2" screws inserted through the work surface into the ledge assembly.	7" x 35" x 7-7/8"	10	\$510	\$556	Single-Wide Add On 7"H Patron Ledge 
ABOCIRDWPL7HS	ABMCIRDWPL7HS	Double-Wide Add On 7"H Patron Ledge Unit is designed to be added onto a double wide desk without a patron ledge. The Patron Ledge Assembly will attach to the desktop by means of #8 x 2-1/2" screws inserted through the work surface into the ledge assembly.	7" x 70" x 7-7/8"	20	\$644	\$702	Double-Wide Add On 7"H Patron Ledge 

Please specify Wood Finish (Table 1) and High-Pressure Laminate (Table 2). Details can be found on page GEN 4.

General Specifications

TABLETOP

Tabletop is 1-3/16" thick, 9-ply solid hardwood plywood or 3-ply 45# density particleboard, with a high-pressure laminate top surface .050" thick and a backing sheet .020" thick for balanced construction. Edges are solid Northern-grown Red Oak or maple. Top receives an external solid drop edge Northern-grown Red Oak or maple band 5/8" x 1-5/8" thick, radiused 1/2" to form a waterfall shape.

Note: Tables with a depth exceeding 48" receive only 1-3/16" thick, 3-ply, 45# density particleboard core.

APRON (OPTIONAL)

A 4"H x 1" thick solid Northern-grown Red Oak or maple apron is fitted between the legs and behind the extended tabletop edge band. Starting 1/2" in from each end, the apron receives a radius that peaks at 2" in the center. The ends of each apron receive a 1/2" radius.

Aprons are attached to the table using wood cleats screwed to the underside of the tabletop. Aprons on round tables go straight between the legs

Note: Aprons are not available for trapezoid shaped tables or Pedestal Base tables.

LEG

The leg is glued up 2-1/4" solid Northern-grown Red Oak or maple. The leg is molded into a triangle shape with the front face receiving a 2" radius and outside edges receiving a 1/2" radius that tapers to a 90° right angle. A 1/4" wide x 1/16" deep horizontal vein line is routed 2" up from the bottom of the leg. A 1/8" chamfer is placed at the bottom of the leg. Each leg receives a 1-1/2" diameter, adjustable glide mounted in a recessed tee-nut which is further recessed into the leg by means of a counter-sink boring which accepts the upper two-thirds of the glide. Legs attach to tabletops by means of a 5" square x 5/16" thick cold-rolled steel plate. The plate is attached to the leg by a 5/16" x 2-1/2" machine bolt engaging a 5/8" diameter barrel nut inserted into the leg. The assembled leg is attached to the tabletop by five 5/16" x 1" machine bolts engaging internal and external threaded bushings embedded in the underside of the tabletop. Leg plates are positioned behind and hidden by the extended table edge band.

TABLETOP SUPPORT

For maximum rigidity, rectangular tables 60" wide or more receive a V-shaped, 14-gauge steel keel securely fastened to the underside of the tabletop. Tables 48"D and more than 60"W, receive two steel keels parallel to the length of the table. Tables 90" or wider receive two extra legs located under the center of the table to provide added support.

Note: Center support legs will be glued up, 2-1/4" square solid Northern-grown Red Oak or maple. All vertical edges of legs receive a 1/2" radius. Bottom edges of legs are chamfered 1/8". Each leg has a 1-1/2" diameter, adjustable glide mounted in a recessed tee-nut. The glide is further recessed into the leg by means of a counter-sunk boring which accepts the upper two-thirds of the glide.

PEDESTAL

Pedestal base will be solid Northern-grown Red Oak or maple. The base consists of four assembled leg components comprised of 6/4 solid material assembled using mortise and tenon construction. The upper horizontal part of the each base leg will receive borings for attaching the assembly to the tabletop. The lower horizontal piece will receive a 1-1/2" diameter, adjustable glide mounted in a recessed tee-nut which is further recessed into the leg by means of a counter-sink boring which accepts the upper two-thirds of the glide. All pedestal base edges will receive a 1/4" radius. The four assembled base components will connect to a 2-1/4" x 2-1/4" solid Northern-grown red oak or maple post using metal to metal hardware fasteners forming a one piece pedestal. Table tops are attached to base by bolting through the upper horizontal members of base into internal and external threaded bushings embedded in the under side of the table top.

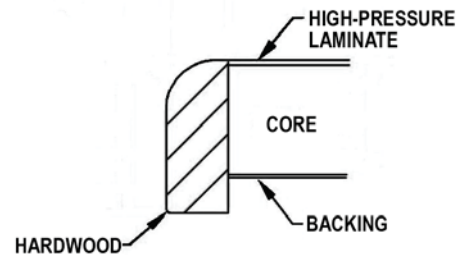

Abridge Drop Edge Band

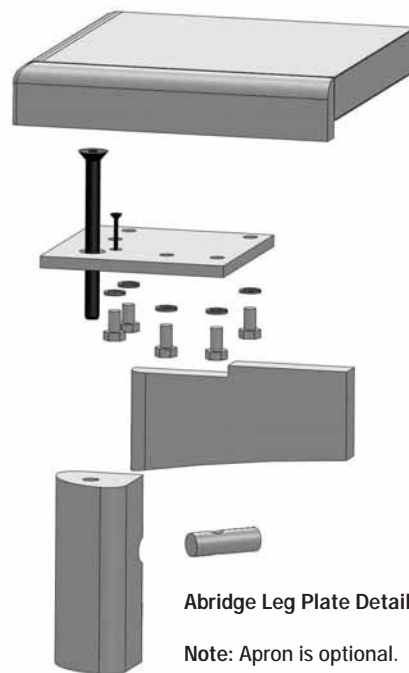

Abridge Leg Plate Detail

Note: Apron is optional.

Plywood Core Catalog No.	Particleboard Core Catalog No.	Description	H x W x D	Wt. (lbs.)	Plywood Core Price	Particleboard Core Price
Round Oak Table						
ABOT36RD29BRTWS	ABOT36RD29ARTWS	Adult Table	29"H x 36" Diameter	100	\$1,480	\$1,371
ABOT36RD27BRTWS	ABOT36RD27ARTWS	Youth Table	27-1/2"H x 36" Diameter	100	\$1,480	\$1,371
ABOT36RD25BRTWS	ABOT36RD25ARTWS	Juvenile Table	25"H x 36" Diameter	100	\$1,480	\$1,371
ABOT42RD29BRTWS	ABOT42RD29ARTWS	Adult Table	29"H x 42" Diameter	110	\$1,584	\$1,450
ABOT42RD27BRTWS	ABOT42RD27ARTWS	Youth Table	27-1/2"H x 42" Diameter	110	\$1,584	\$1,450
ABOT42RD25BRTWS	ABOT42RD25ARTWS	Juvenile Table	25"H x 42" Diameter	110	\$1,584	\$1,450
ABOT48RD29BRTWS	ABOT48RD29ARTWS	Adult Table	29"H x 48" Diameter	120	\$1,642	\$1,488
ABOT48RD27BRTWS	ABOT48RD27ARTWS	Youth Table	27-1/2"H x 48" Diameter	120	\$1,642	\$1,488
ABOT48RD25BRTWS	ABOT48RD25ARTWS	Juvenile Table	25"H x 48" Diameter	120	\$1,642	\$1,488
N/A	ABOT60RD29ARTWS	Adult Table	29"H x 60" Diameter	120	N/A	\$1,785
N/A	ABOT60RD27ARTWS	Youth Table	27-1/2"H x 60" Diameter	120	N/A	\$1,785
N/A	ABOT60RD25ARTWS	Juvenile Table	25"H x 60" Diameter	120	N/A	\$1,785

Round Table



Round Maple Table						
ABMT36RD29BRTWS	ABMT36RD29ARTWS	Adult Table	29"H x 36" Diameter	100	\$1,509	\$1,399
ABMT36RD27BRTWS	ABMT36RD27ARTWS	Youth Table	27-1/2"H x 36" Diameter	100	\$1,509	\$1,399
ABMT36RD25BRTWS	ABMT36RD25ARTWS	Juvenile Table	25"H x 36" Diameter	100	\$1,509	\$1,399
ABMT42RD29BRTWS	ABMT42RD29ARTWS	Adult Table	29"H x 42" Diameter	110	\$1,626	\$1,491
ABMT42RD27BRTWS	ABMT42RD27ARTWS	Youth Table	27-1/2"H x 42" Diameter	110	\$1,626	\$1,491
ABMT42RD25BRTWS	ABMT42RD25ARTWS	Juvenile Table	25"H x 42" Diameter	110	\$1,626	\$1,491
ABMT48RD29BRTWS	ABMT48RD29ARTWS	Adult Table	29"H x 48" Diameter	120	\$1,687	\$1,534
ABMT48RD27BRTWS	ABMT48RD27ARTWS	Youth Table	27-1/2"H x 48" Diameter	120	\$1,687	\$1,534
ABMT48RD25BRTWS	ABMT48RD25ARTWS	Juvenile Table	25"H x 48" Diameter	120	\$1,687	\$1,534
N/A	ABMT60RD29ARTWS	Adult Table	29"H x 60" Diameter	120	N/A	\$1,838
N/A	ABMT60RD27ARTWS	Youth Table	27-1/2"H x 60" Diameter	120	N/A	\$1,838
N/A	ABMT60RD25ARTWS	Juvenile Table	25"H x 60" Diameter	120	N/A	\$1,838



Square Table



Square Oak Table						
ABOT303029BRTWS	ABOT303029ARTWS	Adult Table	29" x 30" x 30"	110	\$1,143	\$1,009
ABOT303027BRTWS	ABOT303027ARTWS	Youth Table	27-1/2" x 30" x 30"	110	\$1,143	\$1,009
ABOT303025BRTWS	ABOT303025ARTWS	Juvenile Table	25" x 30" x 30"	110	\$1,143	\$1,009
ABOT363629BRTWS	ABOT363629ARTWS	Adult Table	29" x 36" x 36"	110	\$1,258	\$1,110
ABOT363627BRTWS	ABOT363627ARTWS	Youth Table	27-1/2" x 36" x 36"	110	\$1,258	\$1,110
ABOT363625BRTWS	ABOT363625ARTWS	Juvenile Table	25" x 36" x 36"	110	\$1,258	\$1,110
ABOT424229BRTWS	ABOT424229ARTWS	Adult Table	29" x 42" x 42"	110	\$1,275	\$1,142
ABOT424227BRTWS	ABOT424227ARTWS	Youth Table	27-1/2" x 42" x 42"	110	\$1,275	\$1,142
ABOT424225BRTWS	ABOT424225ARTWS	Juvenile Table	25" x 42" x 42"	110	\$1,275	\$1,142
ABOT484829BRTWS	ABOT484829ARTWS	Adult Table	29" x 48" x 48"	110	\$1,367	\$1,209
ABOT484827BRTWS	ABOT484827ARTWS	Youth Table	27-1/2" x 48" x 48"	110	\$1,367	\$1,209
ABOT484825BRTWS	ABOT484825ARTWS	Juvenile Table	25" x 48" x 48"	110	\$1,367	\$1,209

Square Maple Table						
ABMT303029BRTWS	ABMT303029ARTWS	Adult Table	29" x 30" x 30"	110	\$1,157	\$1,022
ABMT303027BRTWS	ABMT303027ARTWS	Youth Table	27-1/2" x 30" x 30"	110	\$1,157	\$1,022
ABMT303025BRTWS	ABMT303025ARTWS	Juvenile Table	25" x 30" x 30"	110	\$1,157	\$1,022
ABMT363629BRTWS	ABMT363629ARTWS	Adult Table	29" x 36" x 36"	110	\$1,273	\$1,126
ABMT363627BRTWS	ABMT363627ARTWS	Youth Table	27-1/2" x 36" x 36"	110	\$1,273	\$1,126
ABMT363625BRTWS	ABMT363625ARTWS	Juvenile Table	25" x 36" x 36"	110	\$1,273	\$1,126
ABMT424229BRTWS	ABMT424229ARTWS	Adult Table	29" x 42" x 42"	110	\$1,296	\$1,161
ABMT424227BRTWS	ABMT424227ARTWS	Youth Table	27-1/2" x 42" x 42"	110	\$1,296	\$1,161
ABMT424225BRTWS	ABMT424225ARTWS	Juvenile Table	25" x 42" x 42"	110	\$1,296	\$1,161
ABMT484829BRTWS	ABMT484829ARTWS	Adult Table	29" x 48" x 48"	110	\$1,382	\$1,229
ABMT484827BRTWS	ABMT484827ARTWS	Youth Table	27-1/2" x 48" x 48"	110	\$1,382	\$1,229
ABMT484825BRTWS	ABMT484825ARTWS	Juvenile Table	25" x 48" x 48"	110	\$1,382	\$1,229

Please specify Wood Finish (Table 1) and High-Pressure Laminate (Table 2). Details can be found on page GEN 4. Note: Optional Wood Aprons for Tables are located on page ABR 21.

	Plywood Core Catalog No.	Particleboard Core Catalog No.	Description	H x W x D	Wt. (lbs.)	Plywood Core Price	Particleboard Core Price	
Four-Reader Rectrangular Table 	<i>Four-Reader Rectangular Oak Table</i>							
	ABOT306029BRTWS	ABOT306029ARTWS	Adult Table	29" x 30" x 60"	120	\$1,532	\$1,198	
	ABOT306027BRTWS	ABOT306027ARTWS	Youth Table	27-1/2" x 30" x 60"	120	\$1,532	\$1,198	
	ABOT306025BRTWS	ABOT306025ARTWS	Juvenile Table	25" x 30" x 60"	120	\$1,532	\$1,198	
	ABOT307229BRTWS	ABOT307229ARTWS	Adult Table	29" x 30" x 72"	140	\$1,638	\$1,334	
	ABOT307227BRTWS	ABOT307227ARTWS	Youth Table	27-1/2" x 30" x 72"	140	\$1,638	\$1,334	
	ABOT307225BRTWS	ABOT307225ARTWS	Juvenile Table	25" x 30" x 72"	140	\$1,638	\$1,334	
	<i>Four-Reader Rectangular Maple Table</i>							
	ABMT306029BRTWS	ABMT306029ARTWS	Adult Table	29" x 30" x 60"	120	\$1,617	\$1,269	
	ABMT306027BRTWS	ABMT306027ARTWS	Youth Table	27-1/2" x 30" x 60"	120	\$1,617	\$1,269	
	ABMT306025BRTWS	ABMT306025ARTWS	Juvenile Table	25" x 30" x 60"	120	\$1,617	\$1,269	
	ABMT307229BRTWS	ABMT307229ARTWS	Adult Table	29" x 30" x 72"	140	\$1,714	\$1,399	
ABMT307227BRTWS	ABMT307227ARTWS	Youth Table	27-1/2" x 30" x 72"	140	\$1,714	\$1,399		
ABMT307225BRTWS	ABMT307225ARTWS	Juvenile Table	25" x 30" x 72"	140	\$1,714	\$1,399		
Six-Reader Rectrangular Table 	<i>Six-Reader Rectangular Oak Table</i>							
	ABOT366029BRTWS	ABOT366029ARTWS	Adult Table	29" x 36" x 60"	120	\$1,597	\$1,280	
	ABOT366027BRTWS	ABOT366027ARTWS	Youth Table	27-1/2" x 36" x 60"	120	\$1,597	\$1,280	
	ABOT366025BRTWS	ABOT366025ARTWS	Juvenile Table	25" x 36" x 60"	120	\$1,597	\$1,280	
	ABOT367229BRTWS	ABOT367229ARTWS	Adult Table	29" x 36" x 72"	140	\$1,692	\$1,471	
	ABOT367227BRTWS	ABOT367227ARTWS	Youth Table	27-1/2" x 36" x 72"	140	\$1,692	\$1,471	
	ABOT367225BRTWS	ABOT367225ARTWS	Juvenile Table	25" x 36" x 72"	140	\$1,692	\$1,471	
	ABOT487229BRTWS	ABOT487229ARTWS	Adult Table	29" x 48" x 72"	170	\$1,849	\$1,621	
	ABOT487227BRTWS	ABOT487227ARTWS	Youth Table	27-1/2" x 48" x 72"	170	\$1,849	\$1,621	
	ABOT487225BRTWS	ABOT487225ARTWS	Juvenile Table	25" x 48" x 72"	170	\$1,849	\$1,621	
	<i>Six-Reader Rectangular Maple Table</i>							
	ABMT366029BRTWS	ABMT366029ARTWS	Adult Table	29" x 36" x 60"	120	\$1,617	\$1,299	
	ABMT366027BRTWS	ABMT366027ARTWS	Youth Table	27-1/2" x 36" x 60"	120	\$1,617	\$1,299	
	ABMT366025BRTWS	ABMT366025ARTWS	Juvenile Table	25" x 36" x 60"	120	\$1,617	\$1,299	
	ABMT367229BRTWS	ABMT367229ARTWS	Adult Table	29" x 36" x 72"	140	\$1,714	\$1,493	
	ABMT367227BRTWS	ABMT367227ARTWS	Youth Table	27-1/2" x 36" x 72"	140	\$1,714	\$1,493	
	ABMT367225BRTWS	ABMT367225ARTWS	Juvenile Table	25" x 36" x 72"	140	\$1,714	\$1,493	
	ABMT487229BRTWS	ABMT487229ARTWS	Adult Table	29" x 48" x 72"	170	\$1,872	\$1,645	
ABMT487227BRTWS	ABMT487227ARTWS	Youth Table	27-1/2" x 48" x 72"	170	\$1,872	\$1,645		
ABMT487225BRTWS	ABMT487225ARTWS	Juvenile Table	25" x 48" x 72"	170	\$1,872	\$1,645		

Please specify Wood Finish (Table 1) and High-Pressure Laminate (Table 2). Details can be found on page GEN 4.

Note: Optional Wood Aprons for Tables are located on page ABR 21.

Plywood Core Catalog No.	Particleboard Core Catalog No.	Description	H x W x D	Wt. (lbs.)	Plywood Core Price	Particleboard Core Price
<i>Rectangular Oak Table with Center Support Legs</i>						
ABOT309029BRTWS	ABOT309029ARTWS	Adult Table	29" x 30" x 90"	165	\$2,163	\$1,760
ABOT309027BRTWS	ABOT309027ARTWS	Youth Table	27-1/2" x 30" x 90"	165	\$2,163	\$1,760
ABOT309025BRTWS	ABOT309025ARTWS	Juvenile Table	25" x 30" x 90"	165	\$2,163	\$1,760
ABOT369029BRTWS	ABOT369029ARTWS	Adult Table	29" x 36" x 90"	165	\$2,163	\$1,855
ABOT369027BRTWS	ABOT369027ARTWS	Youth Table	27-1/2" x 36" x 90"	165	\$2,163	\$1,855
ABOT369025BRTWS	ABOT369025ARTWS	Juvenile Table	25" x 36" x 90"	165	\$2,163	\$1,855
ABOT489029BRTWS	ABOT489029ARTWS	Adult Table	29" x 48" x 90"	185	\$2,279	\$1,968
ABOT489027BRTWS	ABOT489027ARTWS	Youth Table	27-1/2" x 48" x 90"	185	\$2,279	\$1,968
ABOT489025BRTWS	ABOT489025ARTWS	Juvenile Table	25" x 48" x 90"	185	\$2,279	\$1,968

Rectangular Table with Center Support Legs



Rectangular Maple Table with Center Support Legs

ABMT309029BRTWS	ABMT309029ARTWS	Adult Table	29" x 30" x 90"	165	\$2,191	\$1,788
ABMT309027BRTWS	ABMT309027ARTWS	Youth Table	27-1/2" x 30" x 90"	165	\$2,191	\$1,788
ABMT309025BRTWS	ABMT309025ARTWS	Juvenile Table	25" x 30" x 90"	165	\$2,191	\$1,788
ABMT369029BRTWS	ABMT369029ARTWS	Adult Table	29" x 36" x 90"	165	\$2,191	\$1,881
ABMT369027BRTWS	ABMT369027ARTWS	Youth Table	27-1/2" x 36" x 90"	165	\$2,191	\$1,881
ABMT369025BRTWS	ABMT369025ARTWS	Juvenile Table	25" x 36" x 90"	165	\$2,191	\$1,881
ABMT489029BRTWS	ABMT489029ARTWS	Adult Table	29" x 48" x 90"	185	\$2,310	\$1,999
ABMT489027BRTWS	ABMT489027ARTWS	Youth Table	27-1/2" x 48" x 90"	185	\$2,310	\$1,999
ABMT489025BRTWS	ABMT489025ARTWS	Juvenile Table	25" x 48" x 90"	185	\$2,310	\$1,999

Trapezoid Oak Table

ABOT60TR29BRTWS	ABOT60TR29ARTWS	Adult Table	29" x 30" x 30" x 60"	120	\$1,766	\$1,439
ABOT60TR27BRTWS	ABOT60TR27ARTWS	Youth Table	27-1/2" x 30" x 30" x 60"	120	\$1,766	\$1,439
ABOT60TR25BRTWS	ABOT60TR25ARTWS	Juvenile Table	25" x 30" x 30" x 60"	120	\$1,766	\$1,439

Trapezoid Table



Trapezoid Maple Table

ABMT60TR29BRTWS	ABMT60TR29ARTWS	Adult Table	29" x 30" x 30" x 60"	120	\$1,844	\$1,449
ABMT60TR27BRTWS	ABMT60TR27ARTWS	Youth Table	27-1/2" x 30" x 30" x 60"	120	\$1,844	\$1,449
ABMT60TR25BRTWS	ABMT60TR25ARTWS	Juvenile Table	25" x 30" x 30" x 60"	120	\$1,844	\$1,449

Note: Aprons are NOT available for Trapezoid Tables.



Catalog No.	Description	Price
LG-CST-S00	Caster add-on to make any table mobile. 3-inch black nylon hooded twin-wheel caster with a brake. Add one caster per table leg (sold each).	\$84

Caster for Abridge Tables



Please specify Wood Finish (Table 1) and High-Pressure Laminate (Table 2). Details can be found on page GEN 4.

Note: Optional Wood Aprons for Tables are located on page ABR 21.

	Plywood Core Catalog No.	Particleboard Core Catalog No.	Description	H x W x D	Wt. (lbs.)	Plywood Core Price	Particleboard Core Price
Round Table with Pedestal Base 	<u>Round Oak Table</u>						
	ABOT36RD29BWPDS	ABOT36RD29AWPDS	Adult Table	29"H x 36" Diameter	100	\$2,010	\$1,923
	ABOT36RD27BWPDS	ABOT36RD27AWPDS	Youth Table	27-1/2"H x 36" Diameter	100	\$2,010	\$1,923
	ABOT36RD25BWPDS	ABOT36RD25AWPDS	Juvenile Table	25"H x 36" Diameter	100	\$2,010	\$1,923
	ABOT42RD29WPDWS	ABOT42RD29AWPDS	Adult Table	29"H x 42" Diameter	110	\$2,096	\$1,988
	ABOT42RD27WPDWS	ABOT42RD27AWPDS	Youth Table	27-1/2"H x 42" Diameter	110	\$2,096	\$1,988
	ABOT42RD25WPDWS	ABOT42RD25AWPDS	Juvenile Table	25"H x 42" Diameter	110	\$2,096	\$1,988
	ABOT48RD29BWPDS	ABOT48RD29AWPDS	Adult Table	29"H x 48" Diameter	120	\$2,138	\$2,017
	ABOT48RD27BWPDS	ABOT48RD27AWPDS	Youth Table	27-1/2"H x 48" Diameter	120	\$2,138	\$2,017
	ABOT48RD25BWPDS	ABOT48RD25AWPDS	Juvenile Table	25"H x 48" Diameter	120	\$2,138	\$2,017
N/A	ABOT60RD29AWPDS	Adult Table	29"H x 60" Diameter	120	N/A	\$2,462	
N/A	ABOT60RD27AWPDS	Youth Table	27-1/2"H x 60" Diameter	120	N/A	\$2,462	
N/A	ABOT60RD25AWPDS	Juvenile Table	25"H x 60" Diameter	120	N/A	\$2,462	
<u>Round Maple Table</u>							
ABMT36RD29BWPDS	ABMT36RD29AWPDS	Adult Table	29"H x 36" Diameter	100	\$2,039	\$1,951	
ABMT36RD27BWPDS	ABMT36RD27AWPDS	Youth Table	27-1/2"H x 36" Diameter	100	\$2,039	\$1,951	
ABMT36RD25BWPDS	ABMT36RD25AWPDS	Juvenile Table	25"H x 36" Diameter	100	\$2,039	\$1,951	
ABMT42RD29BWPDS	ABMT42RD29AWPDS	Adult Table	29"H x 42" Diameter	110	\$2,133	\$2,026	
ABMT42RD27BWPDS	ABMT42RD27AWPDS	Youth Table	27-1/2"H x 42" Diameter	110	\$2,133	\$2,026	
ABMT42RD25BWPDS	ABMT42RD25AWPDS	Juvenile Table	25"H x 42" Diameter	110	\$2,133	\$2,026	
ABMT48RD29BWPDS	ABMT48RD29AWPDS	Adult Table	29"H x 48" Diameter	120	\$2,183	\$2,059	
ABMT48RD27BWPDS	ABMT48RD27AWPDS	Youth Table	27-1/2"H x 48" Diameter	120	\$2,183	\$2,059	
ABMT48RD25BWPDS	ABMT48RD25AWPDS	Juvenile Table	25"H x 48" Diameter	120	\$2,183	\$2,059	
N/A	ABMT60RD29AWPDS	Adult Table	29"H x 60" Diameter	120	N/A	\$2,473	
N/A	ABMT60RD27AWPDS	Youth Table	27-1/2"H x 60" Diameter	120	N/A	\$2,473	
N/A	ABMT60RD25AWPDS	Juvenile Table	25"H x 60" Diameter	120	N/A	\$2,473	
Square Table with Pedestal Base 	<u>Square Oak Table</u>						
	ABOT303029BWPDS	ABOT303029AWPDS	Adult Table	29" x 30" x 30"	110	\$1,739	\$1,631
	ABOT303027BWPDS	ABOT303027AWPDS	Youth Table	27-1/2" x 30" x 30"	110	\$1,739	\$1,631
	ABOT303025BWPDS	ABOT303025AWPDS	Juvenile Table	25" x 30" x 30"	110	\$1,739	\$1,631
	ABOT363629BWPDS	ABOT363629AWPDS	Adult Table	29" x 36" x 36"	110	\$1,809	\$1,703
	ABOT363627BWPDS	ABOT363627AWPDS	Youth Table	27-1/2" x 36" x 36"	110	\$1,809	\$1,703
	ABOT363625BWPDS	ABOT363625AWPDS	Juvenile Table	25" x 36" x 36"	110	\$1,809	\$1,703
	ABOT424229BWPDS	ABOT424229AWPDS	Adult Table	29" x 42" x 42"	110	\$1,845	\$1,738
	ABOT424227BWPDS	ABOT424227AWPDS	Youth Table	27-1/2" x 42" x 42"	110	\$1,845	\$1,738
	ABOT424225BWPDS	ABOT424225AWPDS	Juvenile Table	25" x 42" x 42"	110	\$1,845	\$1,738
ABOT484829BWPDS	ABOT484829AWPDS	Adult Table	29" x 48" x 48"	110	\$1,917	\$1,805	
ABOT484827BWPDS	ABOT484827AWPDS	Youth Table	27-1/2" x 48" x 48"	110	\$1,917	\$1,805	
ABOT484825BWPDS	ABOT484825AWPDS	Juvenile Table	25" x 48" x 48"	110	\$1,917	\$1,805	
<u>Square Maple Table</u>							
ABMT303029BWPDS	ABMT303029AWPDS	Adult Table	29" x 30" x 30"	110	\$1,760	\$1,653	
ABMT303027BWPDS	ABMT303027AWPDS	Youth Table	27-1/2" x 30" x 30"	110	\$1,760	\$1,653	
ABMT303025BWPDS	ABMT303025AWPDS	Juvenile Table	25" x 30" x 30"	110	\$1,760	\$1,653	
ABMT363629BWPDS	ABMT363629AWPDS	Adult Table	29" x 36" x 36"	110	\$1,825	\$1,720	
ABMT363627BWPDS	ABMT363627AWPDS	Youth Table	27-1/2" x 36" x 36"	110	\$1,825	\$1,720	
ABMT363625BWPDS	ABMT363625AWPDS	Juvenile Table	25" x 36" x 36"	110	\$1,825	\$1,720	
ABMT424229BWPDS	ABMT424229AWPDS	Adult Table	29" x 42" x 42"	110	\$1,868	\$1,760	
ABMT424227BWPDS	ABMT424227AWPDS	Youth Table	27-1/2" x 42" x 42"	110	\$1,868	\$1,760	
ABMT424225BWPDS	ABMT424225AWPDS	Juvenile Table	25" x 42" x 42"	110	\$1,868	\$1,760	
ABMT484829BWPDS	ABMT484829AWPDS	Adult Table	29" x 48" x 48"	110	\$1,939	\$1,816	
ABMT484827BWPDS	ABMT484827AWPDS	Youth Table	27-1/2" x 48" x 48"	110	\$1,939	\$1,816	
ABMT484825BWPDS	ABMT484825AWPDS	Juvenile Table	25" x 48" x 48"	110	\$1,939	\$1,816	

Please specify Wood Finish (Table 1) and High-Pressure Laminate (Table 2). Details can be found on page GEN 4. Note: Aprons are NOT available for Pedestal Base Tables.

Optional Wood Curved Aprons for Tables

An Apron is a 4"H x 1" thick, curved oak or maple piece of wood that is fitted between the legs of a table. The Apron is attached to the table using wood cleats that are screwed to the underside of the tabletop. These Aprons are optional and must be ordered separately.

Note: Aprons are not available for Trapezoid Shaped Tables or Pedestal Base Tables.

Oak Catalog No.	Maple Catalog No.	Description	Wt. (lbs.)	Oak Price	Maple Price
ABOAK36RDCAS	ABMAK36RDCAS	For 36" Diameter Table	5	\$294	\$313
ABOAK42RDCAS	ABMAK42RDCAS	For 42" Diameter Table	5	\$346	\$365
ABOAK48RDCAS	ABMAK48RDCAS	For 48" Diameter Table	5	\$370	\$396
ABOAK60RDCAS	ABMAK60RDCAS	For 60" Diameter Table	8	\$408	\$438
ABOAK3030CAS	ABMAK3030CAS	For 30" Square Table	5	\$307	\$321
ABOAK3636CAS	ABMAK3636CAS	For 36" Square Table	5	\$294	\$313
ABOAK4242CAS	ABMAK4242CAS	For 42" Square Table	5	\$346	\$365
ABOAK4848CAS	ABMAK4848CAS	For 48" Square Table	5	\$371	\$396
ABOAK3060CAS	ABMAK3060CAS	For 30" x 60" Table	5	\$358	\$379
ABOAK3072CAS	ABMAK3072CAS	For 30" x 72" Table	5	\$397	\$422
ABOAK3090CAS	ABMAK3090CAS	For 30" x 90" Table	5	\$433	\$463
ABOAK3660CAS	ABMAK3660CAS	For 36" x 60" Table	8	\$365	\$389
ABOAK3672CAS	ABMAK3672CAS	For 36" x 72" Table	8	\$404	\$433
ABOAK3690CAS	ABMAK3690CAS	For 36" x 90" Table	10	\$442	\$474
ABOAK4872CAS	ABMAK4872CAS	For 48" x 72" Table	10	\$506	\$458
ABOAK4890CAS	ABMAK4890CAS	For 48" x 90" Table	12	\$465	\$502

General Specifications

TABLETOP

Tabletop is 1-3/16" thick, 3-ply 45# density particle board, with a high-pressure laminate top surface .050" thick and a backing sheet .020" thick for balanced construction. Edges are solid Northern-grown Red Oak or maple. The top receives a solid drop edge band of Northern-grown Red Oak or maple, 5/8" x 1-5/8" thick, radiused 1/2" to form a waterfall shape.

Note: Standing Height Tables are Apron construction.

TABLETOP SUPPORT

For maximum rigidity, rectangular tables 60" or more wide receive a V-shaped, 14-gauge steel keel securely fastened to the underside of the tabletop. Tables 48"D and more than 60"W, receive two steel keels parallel to the length of the table. Tables 72" or wider receive two extra legs located under the center of the table to provide added support.

Note: Center support legs will be glued up, 2-1/4" square solid Northern-grown Red Oak or maple. All vertical edges of legs receive a 1/2" radius. Bottom edges of legs are chamfered 1/8". Each leg has a 1-1/2" diameter, adjustable glide mounted in a recessed tee-nut. The glide is further recessed into the leg by means of a counter-sunk boring which accepts the upper two thirds of the glide.

PRIVACY PANEL

The privacy panel consists of end panels and a back constructed of 3/4" thick veneered particleboard 6"H x 10-7/16"D. The front edges of the privacy panel end panels receive a 3" radius. Exposed panel edges are banded with 1.6mm solid oak or maple. The privacy panel attaches securely to the tabletop by screws passing through the tabletop and into the privacy panel panels. The privacy panel is finished to match the table and designed to obscure wires exiting computer equipment, to eliminate incidental tampering and create defined patron space.

LEG WITHOUT APRON

The leg is glued up 2-1/4" solid Northern-grown Red Oak or maple. The leg is molded into a triangle shape with the front face receiving a 2" radius and outside edges receiving a 1/2" radius that tapers to a 90° right angle. A 1/4" wide x 1/16" deep vein line is routed 2" up from the bottom of the leg. A 1/8" chamfer is placed at the bottom of the leg. Each leg receives a 1-1/2" diameter, adjustable glide mounted in a recessed tee-nut. The glide is further recessed into the leg by means of a countersink boring which accepts the upper two-thirds of the glide. Legs attach to tabletops by means of a 5" square x 5/16" thick cold rolled steel plate. The plate is attached to the leg by a 5/16" x 2-1/2" machine bolt engaging a 5/8" diameter barrel nut inserted into the leg. The assembled leg is attached to the tabletop by five 5/16" x 1" machine bolts engaging internal and external threaded bushings embedded in the underside of the tabletop. Leg plates are positioned behind and hidden by the extended table edge band.

LEG WITH APRON

Leg is glued up 2-1/4" solid Northern-grown Red Oak or maple. The leg is molded into a triangle shape with the front face receiving a 2" radius and outside edges receiving a 1/2" radius that tapers to a 90° right angle. A 1/4" wide x 1/16" deep vein line is routed 2" up from the bottom of the leg. A 1/8" chamfer is placed at the bottom of the leg. Each leg receives a 1-1/2" diameter, adjustable glide mounted in a recessed tee-nut which is further recessed into the leg by means of a countersink boring that accepts the upper two-thirds of the glide. Legs attach to the aprons by means of formed 14-gauge steel corner brackets. Each leg is bolted to the corner bracket with two 5/16" - 18 hex head bolts which pass through the bracket and engage threaded bushings, embedded into the leg and cross-pinned with a 3/16" diameter steel pin.

APRON (Standard for Standing Height, Optional for Sitting Height)

A 4"H x 1" thick solid Northern-grown Red Oak or maple apron is fitted between the legs and behind the extended tabletop edge band. Starting 1/2" in from each end, the apron receives a radius that peaks at 2" in the center. The ends of each apron receive a 1/2" radius. Aprons are attached to the table by means of wood cleats and formed 14-gauge steel corner brackets. Aprons on round tables go straight between the legs.

LEG (CENTER)

Center support legs will be glued up, 2-1/4" square solid Northern-grown Red Oak or maple. All vertical edges of legs receive a 1/2" radius. Bottom edges of legs are chamfered 1/8". Each leg has a 1-1/2" diameter, adjustable glide mounted in a recessed tee-nut. The glide is further recessed into the leg by means of a counter-sunk boring which accepts the upper two-thirds of the glide. Legs attach to tabletops by means of a 5" square x 5/16" thick cold-rolled steel plate. The plate is attached to the leg by a 5/16" x 2-1/2" machine bolt engaging a 5/8" diameter barrel nut inserted into the leg. The assembled leg is attached to the tabletop by five 5/16" x 1" machine bolts engaging internal and external threaded bushings embedded in the underside of the tabletop. Leg plates are positioned behind and hidden by the extended table edge band.

ELECTRICAL

Each position on an Information Access Table receives one 3" diameter grommet for wire passage and J-channel wire manager to hold excess wires. Grommets are ABS black plastic with notched removable cap. J-channel is 18-gauge steel with electrostatically applied black powder paint and is mounted to the underside of the tabletop.

TABLETOP HEIGHT

Standing Height: 39" (with Apron)
Sitting Height: 27-1/2" (without Apron)

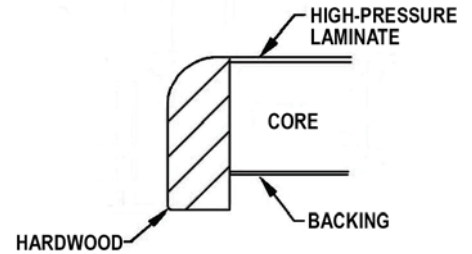

Abridge Drop Edge Band

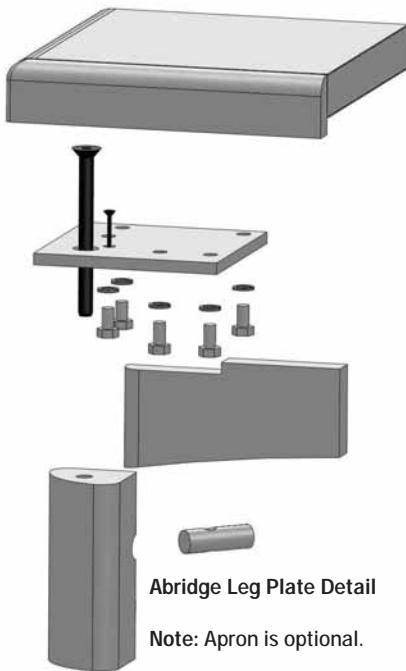

Abridge Leg Plate Detail

Note: Apron is optional.

The Abridge Collection

Sitting Height Computer Tables

	Oak Catalog No.	Maple Catalog No.	Description	H x W x D	Wt. (lbs.)	Oak Price	Maple Price
One Position Computer Tables	ABOITGO243027RTWS	ABMITGO243027RTWS	Sitting Height	27-1/2" x 30" x 24"	80	\$1,156	\$1,201
	ABOITGO303027RTWS	ABMITGO303027RTWS	Sitting Height	27-1/2" x 30" x 30"	80	\$1,232	\$1,280



Two Position Computer Tables	ABOITGO246027RTWS	ABMITGO246027RTWS	Sitting Height	27-1/2" x 60" x 24"	80	\$1,642	\$1,708
	ABOITGO306027RTWS	ABMITGO306027RTWS	Sitting Height	27-1/2" x 60" x 30"	80	\$1,768	\$1,839



One Position Computer Table with 6"H Privacy Panel	ABOITGS243627RTWS	ABMITGS243627RTWS	Sitting Height	27-1/2" x 36" x 24"	70	\$1,431	\$1,546
	ABOITGS363627RTWS	ABMITGS363627RTWS	Sitting Height	27-1/2" x 36" x 36"	80	\$1,556	\$1,680



Two Position Computer Table with 6"H Privacy Panel	ABOITGS247227RTWS	ABMITGS247227RTWS	Sitting Height	27-1/2" x 72" x 24"	150	\$1,909	\$2,073
	ABOITGS367227RTWS	ABMITGS367227RTWS	Sitting Height	27-1/2" x 72" x 36"	150	\$2,075	\$2,241





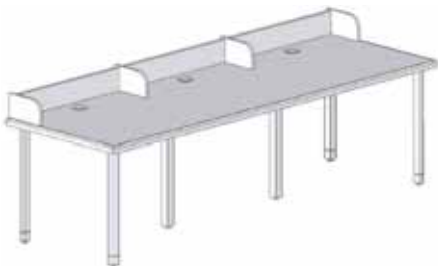

Three Position Computer Table with 6"H Privacy Panel	ABOITGS249027RTWS	ABMITGS249027RTWS	Sitting Height	27-1/2" x 90" x 24"	180	\$2,560	\$2,778
	ABOITGS369027RTWS	ABMITGS369027RTWS	Sitting Height	27-1/2" x 90" x 36"	170	\$2,781	\$3,003



Please specify Wood Finish (Table 1) and High-Pressure Laminate (Table 2). Details can be found on page GEN 4.

Note: Optional Wood Aprons for Computer Tables are located on page ABR 26.

Note: Curved Apron is Standard on Standing Height Tables.

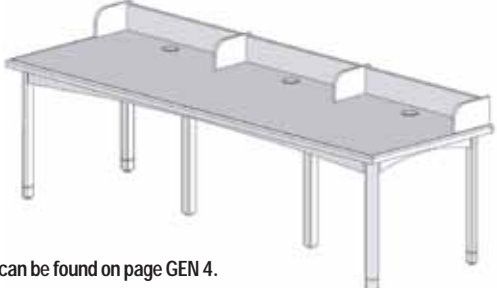
Oak Catalog No.	Maple Catalog No.	Description	H x W x D	Wt. (lbs.)	Oak Price	Maple Price	
ABOITGO303039RTAS	ABMITGO303039RTAS	Standing Height	39" x 30" x 30"	85	\$1,344	\$1,404	One Position Computer Tables 
ABOITGO306039RTAS	ABMITGO306039RTAS	Standing Height	39" x 60" x 30"	115	\$1,860	\$1,927	Two Position Computer Tables 
ABOITGS363639RTAS	ABMITGS363639RTAS	Standing Height	39" x 36" x 36"	85	\$1,619	\$1,745	One Position Computer Table with 6"H Privacy Panel 
ABOITGS367239RTAS	ABMITGS367239RTAS	Standing Height	39" x 72" x 36"	150	\$2,161	\$2,332	Two Position Computer Table with 6"H Privacy Panel 
ABOITGS369039RTAS	ABMITGS369039RTAS	Standing Height	39" x 90" x 36"	180	\$2,896	\$3,127	Three Position Computer Table with 6"H Privacy Panel 

Please specify Wood Finish (Table 1) and High-Pressure Laminate (Table 2). Details can be found on page GEN 4.
Note: Optional Wood Aprons for Computer Tables are located on page ABR 26.

Optional Wood Curved Aprons for Sitting Height Computer Tables

An Apron is a 4"H x 1" thick, curved oak or maple piece of wood that is fitted between the legs of a table. The Apron is attached to the table using wood cleats that are screwed to the underside of the tabletop. These Aprons are optional and must be ordered separately.

Note: Curved Apron is Standard on Standing Height Tables.

Oak Catalog No.	Maple Catalog No.	Description	Wt. (lbs.)	Oak Price	Maple Price
ABOAK2430CAS	ABMAK2430CAS	For 24" x 30" Table	5	\$290	\$302
ABOAK2436CAS	ABMAK2436CAS	For 24" x 36" Table	5	\$278	\$290
ABOAK2460CAS	ABMAK2460CAS	For 24" x 60" Table	5	\$340	\$356
ABOAK2472CAS	ABMAK2472CAS	For 24" x 72" Table	5	\$379	\$397
ABOAK2490CAS	ABMAK2490CAS	For 24" x 90" Table	8	\$415	\$435
ABOAK3030CAS	ABMAK3030CAS	For 30" Square Table	5	\$307	\$321
ABOAK3636CAS	ABMAK3636CAS	For 36" Square Table	5	\$358	\$379
ABOAK3060CAS	ABMAK3060CAS	For 30" x 60" Table	5	\$294	\$313
ABOAK3672CAS	ABMAK3672CAS	For 36" x 72" Table	8	\$404	\$433
ABOAK3690CAS	ABMAK3690CAS	For 36" x 90" Table	10	\$442	\$474

General Specifications

WORK SURFACE

Work surface is 1-3/16" thick, 3-ply, 45# density particleboard core, with a high-pressure laminate top surface .050" thick and a backing sheet .020" thick for balanced construction. The front edge of the work surface receives a drop edge band of Northern-grown Red Oak or maple, 5/8" x 1-5/8" thick with a 1/2" radius to form a waterfall shape. The back edge of the work surface has a black plastic strip, 1-1/2"W, which projects above the work surface 1/4" to act as a retainer.

Work surface is 27-1/2"D with an additional 1-1/2"W cord drop available in two widths: 48" and 36", and adjustable in heights to 27", 32" and 39". Workstation is of modular starter and adder design. Work surface is attached to end and intermediate panels by means of two metal 23" long "Z" brackets with 5/16" x #18 hex-head bolts engaging embedded internal and external threaded bushings. The back panel is attached to end and intermediate panels using hidden metal keyways and shoulder screws. The shelf is attached to end, intermediate and back panels with 3/4" x 3/4" steel, black painted angle brackets and black #8 screws.

END PANEL

End panel consists of a framed panel and plinth base assembly. The framed panel assembly consists of Northern-grown Red Oak or maple hardwood rails and stiles with a veneered panel. The panel is 3/4" thick plain-sliced slip-matched Northern-grown Red Oak or maple. The top rail is 2"H x 1" thick and side stiles are 1" x 1" with a 1" radius. The plinth base is composed of one piece of 5/4 solid Northern-grown Red Oak or maple 2-1/4"H x 1" thick. The plinth base receives a molded shape at the top which consists of a 1" radius ending in a 1/4"W reveal and is attached to the bottom of the frame panel assembly by means of three #8 x 3" long flat-head screws and wood glue. The bottom of the plinth receives two 7/8" diameter chrome adjustable glides located 1-1/4" from the plinth ends. End panel attaches to back panels by means of recessed metal fasteners and shoulder screws.

INTERMEDIATE PANEL

Intermediate panels are 1" thick, 3-ply 45# density particleboard core, with select plain-sliced slip-matched Northern-grown Red Oak or maple veneers. The panel will receive a 1.6mm solid oak or maple band on all four (4) sides. Each panel receives a 3" diameter egress grommet to provide for wire passage and two 7/8" diameter chrome adjustable glides located 1-1/4" from the ends. Intermediate panel attaches to back panels by means of recessed metal fasteners and shoulder screws.

BACK PANEL

Back panel is 3/4" thick, 45# density particleboard core of select Northern-grown Red Oak or maple face veneers. The top and bottom edge of the back panel receives 1.6mm solid oak or maple band. Back panels attach to end and intermediate panels by means of recessed metal fasteners and shoulder screws. The back panel on double-faced units receives a 3" diameter grommet located below the work surface to allow passage of electrical and data wires.

SHELF

A 12"D storage shelf, located under the work surface, extends the full width of the station.

ELECTRICAL

To hide excess wires, a 1-1/2" separation between the work surface and back panel is provided.

WORKING SPACE HEIGHTS

Adjustable at 27", 32" and 39"

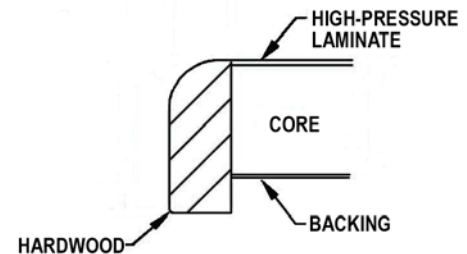

Abridge Drop Edge Band

	Oak Catalog No.	Maple Catalog No.	Description	H x W x D	Wt. (lbs.)	Oak Price	Maple Price
Single-Faced Information Access Workstations/Carrels	<u>36" Wide Adjustable Height Working Space</u>						
	ABOICSFS36S	ABMICSFS36S	S/F Starter	47-3/4" x 38" x 34-1/2"	85	\$2,098	\$2,408
	ABOICSFA36S	ABMICSFA36S	S/F Adder	47-3/4" x 37" x 34-1/2"	75	\$1,628	\$1,803

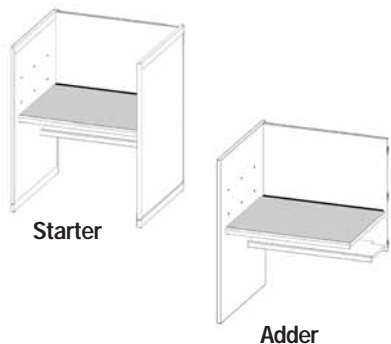

	<u>48" Wide Adjustable Height Working Space</u>						
	ABOICSFS48S	ABMICSFS48S	S/F Starter	47-3/4" x 49-3/4" x 34-1/2"	90	\$2,230	\$2,537
	ABOICSFA48S	ABMICSFA48S	S/F Adder	47-3/4" x 49" x 34-1/2"	80	\$1,732	\$1,912

Double-Faced Information Access Workstations/Carrels	<u>36" Wide Adjustable Height Working Space</u>						
	ABOICDFS36S	ABMICDFS36S	D/F Starter	47-3/4" x 38" x 68"	140	\$3,808	\$4,270
	ABOICDFA36S	ABMICDFA36S	D/F Adder	47-3/4" x 37" x 68"	126	\$2,912	\$3,356

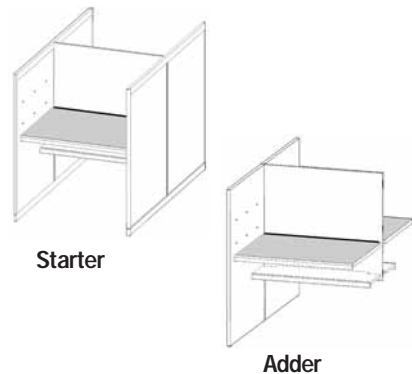

	<u>48" Wide Adjustable Height Working Space</u>						
	ABOICDFS48S	ABMICDFS48S	D/F Starter	47-3/4" x 49-3/4" x 68"	150	\$4,133	\$4,727
	ABOICDFA48S	ABMICDFA48S	D/F Adder	47-3/4" x 49" x 68"	136	\$3,249	\$3,596

Pinwheel Design Information Access Workstations/Carrels	<u>36" Wide Adjustable Height Working Space</u>						
	ABOICPIN36S	ABMICPIN36S	Pinwheel	47-3/4" x 75" x 75"	375	\$6,445	\$7,390

	<u>48" Wide Adjustable Height Working Space</u>						
	ABOICPIN48S	ABMICPIN48S	Pinwheel	47-3/4" x 99" x 99"	425	\$6,979	\$7,927

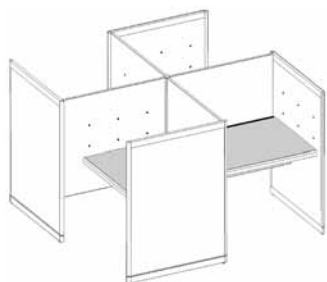

Please specify Wood Finish (Table 1) and High-Pressure Laminate (Table 2). Details can be found on page GEN 4.

General Specifications

WORKSTATION

Workstation is of modular starter and adder design, with an overall height 35-1/4". Work surfaces are available in 36", 48", 73", 97", and 110" widths. A knee-space panel, located below the work surface, supports all work surfaces greater than 48"W. Work surface height is at 27-1/2" and depth is 22-1/2" with a 1-1/2"W cord drop. The work surface is attached to end and intermediate panels by means of two metal 16" long "Z" brackets with 5/16" x #18 hex-head bolts engaging embedded internal and external threaded bushings. The back panel is attached to end and intermediate panels using hidden metal keyways and shoulder screws. The shelf is attached to end, intermediate, and back panels with 1" x 1" steel, black painted angle brackets and black #8 screws.

WORK SURFACE

Work surface is 1-3/16" thick, 3-ply, 45# density particleboard core, with a high-pressure laminate top surface .050" thick and a backing sheet .020" thick for balanced construction. The front edge of the work surface receives a drop edge band of Northern-grown Red Oak or Maple, 5/8" x 1-5/8" thick with a 1/2" radius to form a waterfall shape. The back edge of the work surface has a plastic black strip, 1-1/2"W, which projects above the work surface 1/4" to act as a retainer.

END PANEL

End panel consists of a framed panel assembly. The framed panel assembly consists of Northern-grown Red Oak or Maple hardwood rails and stiles with a veneered panel. The panel is 3/4" thick plain-sliced slip-matched Northern-grown Red Oak or Maple routed on two (2) edges. The top and bottom rails are 2"H x 1" thick and side bands are 1" x 1" with a 1" radius. The bottom rail is screwed on using #8 x 3" long flat-head screws and wood glue. The side bands receive a 1/4" x 1/16" vein line 2" up from the bottom of the panel. The bottom of the end panel receives two 7/8" diameter chrome adjustable glides located 1-1/2" from the ends. End panel attaches to back panels by means of recessed metal fasteners and shoulder screws.

INTERMEDIATE PANEL

Intermediate panel is 1" thick, 3-ply 45# density particleboard core, with select plain sliced slip matched Northern-grown Red Oak or Maple veneers. The panel receives a 1" x 1.6mm solid oak or maple band. Each panel receives a 3" diameter egress grommet to provide for wire passage and two 7/8" diameter chrome adjustable glides located 1-1/2" from the ends. Intermediate panel attaches to back panels by means of recessed metal fasteners and shoulder screws.

BACK PANEL/PARTITION

Back panel is 3/4" thick, 45# density particleboard core of select Northern-grown Red Oak or Maple face veneers. The top and bottom edge of the back panel receives 1.6mm solid oak or maple band. Back panels attach to end and intermediate panels by means of recessed metal fasteners and shoulder screws. The partition on double-faced units receives a 3" diameter grommet located below the work surface to allow passage of electrical and data wires.

SHELF

Shelf is 3/4" thick x 5"D 45# density particleboard core with face veneers of select Northern-grown Red Oak or Maple. Shelf is banded on the front edge with a 1.6mm solid oak or maple band. The shelf is attached to end and intermediate panels with 1" x 1" steel, black painted angle brackets and black #8 screws. Back corners of shelf have a 3" x 3" cutout to allow for the passage of electrical cords. The shelf is positioned 11-13/16" below the bottom of the work surface.

WIRE MANAGEMENT DOOR

The wire management door is positioned between the bottom of the work surface and the shelf and is designed to form a concealed wire management channel 5"D x 11-5/16"H. The door is 1/4" thick with select oak or maple face veneers. The door slides in two aluminum tracks, one that is attached to the bottom of the work surface while the other is attached to the top of the shelf.

KNEE-SPACE PANEL

All 72" and 96"W workstations, as well as functional corner units, have a knee-space panel positioned under the work surface for additional work-surface support. Units 110"W have two knee-space panels. The knee-space panel is 1" thick, 3 ply 45# density particleboard core with select Northern-grown Red Oak or Maple face veneers. The panel is banded on exposed edges with a 1.6mm solid oak or maple band. The knee-space panel is attached to the back panel using a 1" square, solid oak or maple post. Panels attach to the post using recessed metal fasteners and shoulder screws. The knee-space panel is angled in the back to create a space to allow passage of electrical and data cords. The knee-space panel receives one 7/8" diameter chrome adjustable glide.

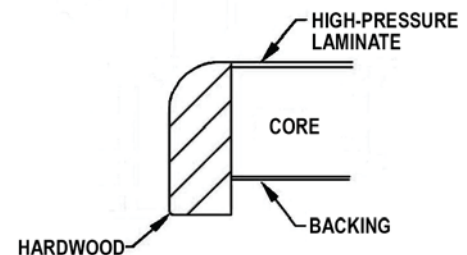

Abridge Drop Edge Band

	Oak Catalog No.	Maple Catalog No.	Description	H x W x D	Wt. (lbs.)	Oak Price	Maple Price
Single-Faced One-Position							
<i>36" Wide Working Space</i>							
	ABOMMSSF1S36S	ABMMMSDF1S36S	One-Position S/F Starter	35-1/4" x 38" x 26"	130	\$2,128	\$2,282
	ABOMMSSF1A36S	ABMMMSDF1A36S	One-Position S/F Adder	35-1/4" x 37" x 26"	100	\$1,456	\$1,585
<i>48" Wide Working Space</i>							
	ABOMMSSF1S48S	ABMMMSDF1S48S	One-Position S/F Starter	35-1/4" x 50" x 26"	155	\$2,288	\$2,461
	ABOMMSSF1A48S	ABMMMSDF1A48S	One-Position S/F Adder	35-1/4" x 49" x 26"	125	\$1,568	\$1,709
Double-Faced One-Position							
<i>36" Wide Working Space</i>							
	ABOMMSDF1S36S	ABMMMSDF1S36S	One-Position D/F Starter	35-1/4" x 38" x 51"	215	\$3,352	\$3,588
	ABOMMSDF1A36S	ABMMMSDF1A36S	One-Position D/F Adder	35-1/4" x 37" x 51"	155	\$2,464	\$2,730
<i>48" Wide Working Space</i>							
	ABOMMSDF1S48S	ABMMMSDF1S48S	One-Position D/F Starter	35-1/4" x 50" x 51"	255	\$3,564	\$3,842
	ABOMMSDF1A48S	ABMMMSDF1A48S	One-Position D/F Adder	35-1/4" x 49" x 51"	195	\$2,688	\$2,924
Single-Faced Two-Position							
<i>36" Wide Working Space</i>							
	ABOMMSSF2S36S	ABMMMSDF2S36S	Two-Position S/F Starter	35-1/4" x 75" x 26"	195	\$2,980	\$3,226
	ABOMMSSF2A36S	ABMMMSDF2A36S	Two-Position S/F Adder	35-1/4" x 74" x 26"	165	\$2,296	\$2,516
<i>48" Wide Working Space</i>							
	ABOMMSSF2S48S	ABMMMSDF2S48S	Two-Position S/F Starter	35-1/4" x 99" x 26"	235	\$3,308	\$3,592
	ABOMMSSF2A48S	ABMMMSDF2A48S	Two-Position S/F Adder	35-1/4" x 98" x 26"	205	\$2,464	\$2,703
Double-Faced Two-Position							
<i>36" Wide Working Space</i>							
	ABOMMSDF2S36S	ABMMMSDF2S36S	Two-Position D/F Starter	35-1/4" x 75" x 51"	330	\$4,770	\$5,118
	ABOMMSDF2A36S	ABMMMSDF2A36S	Two-Position D/F Adder	35-1/4" x 74" x 51"	270	\$3,883	\$4,212
<i>48" Wide Working Space</i>							
	ABOMMSDF2S48S	ABMMMSDF2S48S	Two-Position D/F Starter	35-1/4" x 99" x 51"	410	\$5,186	\$5,612
	ABOMMSDF2A48S	ABMMMSDF2A48S	Two-Position D/F Adder	35-1/4" x 98" x 51"	155	\$4,305	\$4,675

Please specify Wood Finish (Table 1) and High-Pressure Laminate (Table 2).
Details can be found on page GEN 4.

Oak Catalog No.	Maple Catalog No.	Description	HxWxD	Wt. (lbs.)	Oak Price	Maple Price
36" Wide Working Space						
ABOMMSSF3S36S	ABMMMSSF3S36S	Three-Position S/F Starter	35-1/4" x 112" x 26"	260	\$3,862	\$4,197
ABOMMSSF3A36S	ABMMMSSF3A36S	Three-Position S/F Adder	35-1/4" x 111" x 26"	230	\$3,024	\$3,327

Single-Faced Three-Position

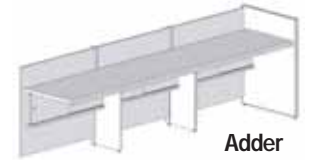

36" Wide Working Space						
ABOMMSDF3S36S	ABMMMDF3S36S	Three-Position D/F Starter	35-1/4" x 112" x 51"	445	\$6,151	\$6,612
ABOMMSDF3A36S	ABMMMDF3A36S	Three-Position D/F Adder	35-1/4" x 111" x 51"	385	\$5,489	\$6,184

Double-Faced Three-Position

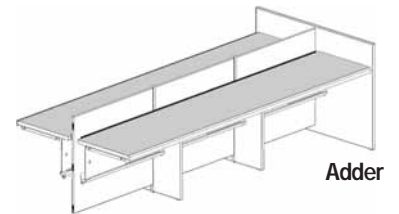
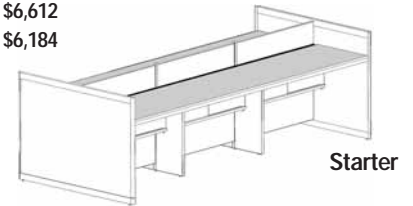

ABOMMSCNRSS	ABMMMCSRSS	90-Degree Functional Starter	35-1/4" x 62" x 26"	225	\$4,019	\$4,358
ABOMMSCNRAS	ABMMMCSRAS	90-Degree Functional Adder	35-1/4" x 62" x 26"	195	\$3,782	\$4,108

90° Functional Corner Unit

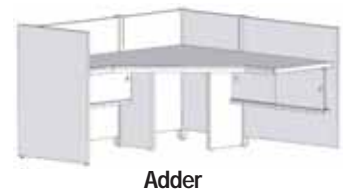
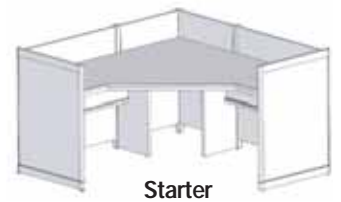

Please specify Wood Finish (Table 1) and High-Pressure Laminate (Table 2).
 Details can be found on page GEN 4.

General Specifications

TABLETOP

Tabletop is 1-3/16" thick, 3-ply 45# density particle board, with a high-pressure laminate top surface .050" thick and a backing sheet .020" thick for balanced construction. Edges are solid Northern-grown Red Oak or maple. Top receives a Northern-grown Red Oak or maple external solid flush edge band 5/8" x 1-3/16" thick, radiused 1/2" to form a waterfall shape.

PRIVACY PANEL

Privacy panels consist of two panels constructed of 3/4" thick Northern-grown Red oak or maple veneered particleboard. The two panels are 6"H x 45"W and intersect in the middle of the tabletop to form an "X". Privacy panels receive keyways and shoulder screws for assembly. The front edge of the privacy panel end panel receives a 3" radius. Exposed panel edges are banded with 1.6mm solid oak or maple. The privacy panel attaches securely to the tabletop by screws passing through the tabletop and into the privacy panel. Panels are finished to match the table edge band. Privacy panel is designed to obscure wires exiting computer equipment, to eliminate incidental tampering and create defined patron space.

TABLE BASE

Table base is panel and post construction. Posts are 1-3/4" square, with a 3/4"W x 1/8"D groove to receive panels. Each post has a 1-1/4" diameter, adjustable glide. Base back and vertical panels are 3/4" 3-ply 45# Northern-grown Red Oak or Maple veneered particleboard. Back panels are 23-1/2"H with a 4" base clearance for wire management access. Vertical panels are 26-5/16"H and receive two rubber cushioned chrome glides per panel. Base is assembled using metal to metal hardware fasteners and is attached to tabletop using 12" x 3/4" x 3/4" wood cleats.

WORKING SPACE HEIGHT

Fixed at 27" with a grommet in each position for wire passage.

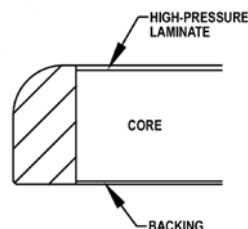

Abridge Flush Edge Band

	Oak Catalog No.	Maple Catalog No.	Description	HxWxD	Wt. (lbs.)	Oak Price	Maple Price
Square Working Space	ABOPAC4PS27GSS	ABMPAC4PS27GSS	Square with Privacy Panel	33-1/2" x 48-1/4" x 48-1/4"	360	\$2,678	\$3,065
	ABOPAC4PS27GOS	ABMPAC4PS27GOS	Square without Privacy Panel	27-1/2" x 48-1/4" x 48-1/4"	350	\$2,342	\$2,729

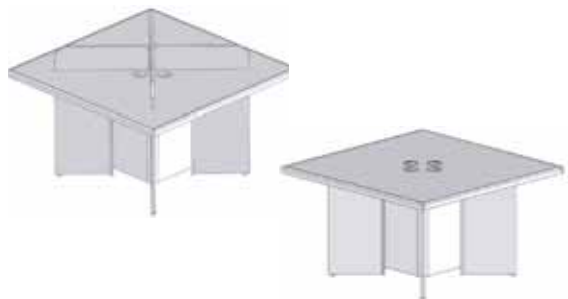

Octagon Working Space	ABOPAC4PO27GSS	ABMPAC4PO27GSS	Octagon with Privacy Panel	33-1/2" x 48-1/4" x 48-1/4"	370	\$3,014	\$3,394
	ABOPAC4PO27GOS	ABMPAC4PO27GOS	Octagon without Privacy Panel	27-1/2" x 48-1/4" x 48-1/4"	360	\$2,678	\$3,058



Please specify Wood Finish (Table 1) and High-Pressure Laminate (Table 2).
Details can be found on page GEN 4.

General Specifications

WORK SURFACE

Work surface are 1-3/16" thick, 3-ply, 45# density particleboard core, with a high-pressure laminate top surface .050" thick and a backing sheet .020" thick for balanced construction. The desk top receives a solid Northern-grown Red Oak or maple flush edge band 5/8" x 1-3/16" thick, radiused 1/2" to form a waterfall shape on the patron side. Edge band is applied to the desktop after the laminate and backer sheets are applied, constituting an external edge band.

VERTICAL PANEL

Vertical panel is 1" thick, with select plain-sliced slip-matched Northern-grown Red Oak or maple veneers. The panel receives a 1" x 1.6mm solid oak or maple band. Each panel receives a 3" diameter egress grommet to provide for wire passage and two 7/8" diameter chrome adjustable glides located 1-1/4" from the ends. The intermediate panel attaches to back panels by means of recessed metal fasteners and shoulder screws.

BACK PANEL

Back panel is 3/4" thick, 45# density particleboard core of select Northern-grown Red Oak or maple face veneers. The top and bottom edges of the back panel receive 1.6mm solid oak or maple bands. Back panels attach to end and intermediate panels by means of recessed metal fasteners and shoulder screws. The back panel receives a 3" diameter grommet located below the work surface to allow passage of electrical and data wires.

ELECTRICAL ACCESS DOOR

Access door is 3/4" thick and comprised of select face veneers of Northern-grown Red Oak or maple over a particleboard core. Panel is externally banded on all four sides with a 1.6mm solid oak or maple edge band. Access door has a full-length hinge and lock and can be located in any one of the back panels on the station.

CPU/UTILITY SHELF

Shelf is 3/4" thick x 15"D, 7-ply veneer-core oak or maple plywood construction. Front edge receives a 1/2" solid oak or maple band.

CENTER CAP

Cap is constructed of 3/4" particleboard core with plastic and backer. Available in full-hexagon, half-hexagon, or square configuration; the cap closes the center opening by mounting at the top rear edge of end panels on systems arranged in full- or half-hexagon configuration.

AVAILABLE WORKING SPACE

Depth of monitor and keyboard combined cannot exceed 29".

WORKING SPACE HEIGHTS

Working space is adjustable to:
 Standing Height: 39"
 ADA Height: 32"
 Sitting Height: 27"

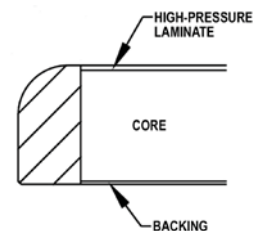

Abridge Flush Edge Band

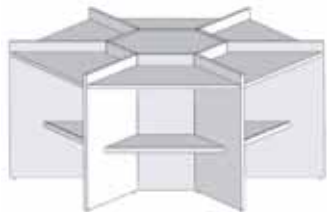
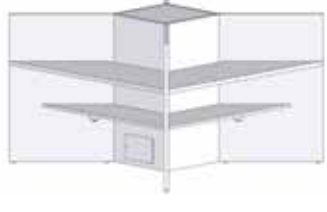
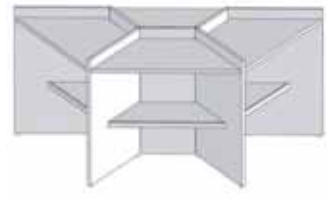
Oak Catalog No.	Maple Catalog No.	Description	H x W x D	Wt. (lbs.)	Oak Price	Maple Price	
ABOPAC6PAHS	ABMPAC6PAHS	Six position with angular tops.	42-1/4" x 99-1/4" x 99-1/4"	629	\$9,622	\$10,963	Six Position PAC Station 
ABOPAC4PAHS	ABMPAC4PAHS	Four position with angular tops.	42-1/4" x 75-1/2" x 75-1/2"	510	\$8,200	\$8,764	Four Position PAC Station 
ABOPAC3PAHS	ABMPAC3PAHS	Three position with angular tops. Composed of one starter unit and two adder units.	42-1/4" x 99-1/2" x 47-1/2"	401	\$6,002	\$6,941	Three Position PAC Station 

Please specify Wood Finish (Table 1) and High-Pressure Laminate (Table 2).
 Details can be found on page GEN 4.

General Specifications

WORK SURFACE

Work surface is 1-3/16" thick, 3-ply, 45# density particleboard core, with a high-pressure laminate top surface .050" thick and a backing sheet .020" thick for balanced construction. The exposed work surface edge receives a Northern-grown Red Oak or maple drop edge band 5/8" x 1-3/16" thick with a 1/2" radius to form a waterfall shape. The back edge of the work surface has a metal black strip, 1-1/2"W, which projects above the work surface 1/4" to act as a retainer.

END PANEL

End panel consists of a framed panel and plinth base assembly. The framed panel assembly consists of solid Northern-grown Red Oak or maple hardwood rails and stiles with a veneered panel. The panel is 3/4" thick plain sliced slip matched Northern grown Red Oak or maple routed on three sides. The top rail is 2"H x 1" thick and side stiles are 1" x 1" with a 1" radius. The plinth base is composed of one piece of 5/4 solid Northern-grown Red Oak or maple 2-1/4"H x 1" thick. The plinth base receives a molded shape at the top which consists of a 1" radius ending in a 1/4"W reveal and is attached to the bottom of the frame panel assembly by means of three #8 x 3" long flat-head screws and wood glue. The bottom of the plinth receives two 7/8" diameter chrome adjustable glides located 1-1/4" from the plinth ends. End panel attaches to back panels by means of recessed metal fasteners and shoulder screws.

BACK PANEL

Back panel is select Northern-grown Red Oak or maple face veneer 3/4" thick, 3-ply 45# density particleboard core of. The top and bottom edge of the back panel receives 1.6mm solid oak or maple band. Back panels attach to end and intermediate panels by means of recessed metal fasteners and shoulder screws. The back panel on double-face units receives a 3" diameter grommet located below the work surface to allow passage of electrical and data wires.

SHELF (MONITOR)

Monitor shelf is 1-3/16" thick, 3-ply, 45# density particleboard core, with a high-pressure laminate top surface .050" thick and a backing sheet .020" thick for balanced construction. Laminate has a lo-glare finish resistant to scratches, fading and staining that meets or exceeds NEMA standards. The exposed work surface edge receives a Northern-grown Red Oak or maple flush edge band 5/8" x 1-3/16" thick with a 1/2" radius to form a waterfall shape. Shelf receives one 3" diameter grommet for wire passage.

SHELF (PRINTER)

Printer shelf shall have a fascia, 1-3/4"H x 3/4" thick of solid oak banded to a 3/4" 3-ply 45# density particleboard core of specified depth. The top front corner shall have a 1/8" radius. Glue blocks will also be provided at the intersection of the fascia and top panel. Printer shelf is mounted as pull out shelf on 100# capacity nylon glides.

SHELF (FIXED)

Shelf is constructed of 3-ply 45# density particleboard core, with Northern-grown Red Oak plain sliced face veneer or maple plain sliced face veneer. Exposed edges receive a 1.6mm thick, solid-oak or maple edge band.

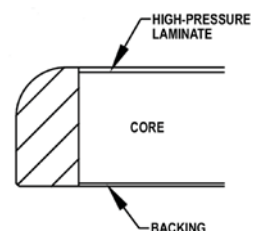

Abridge Drop Edge Band

	Oak Catalog No.	Maple Catalog No.	Description	H x W x D	Wt. (lbs.)	Oak Price	Maple Price
Self Check Out Station	ABOSCS323643S	ABMSCS323643S	Self Check Out Station	43-1/2" x 36" x 32"	220	\$1,930	\$2,397



Please specify Wood Finish (Table 1) and High-Pressure Laminate (Table 2).
Details can be found on page GEN 4.

General Specifications

END OF RANGE PAC STATION – Free Standing

Unit is designed to fit at the end of a double-faced shelving range. Standard tops are 1-3/16" thick, 3-ply, 45# density particleboard core, with a high-pressure laminate top surface .050" thick and a backing sheet .020" thick for balanced construction. The desk top receives a solid Northern-grown Red Oak or maple flush edge band 5/8" x 1-3/16" thick, radiused 1/2" to form a waterfall shape. Edge band is applied to the top after the laminate and backer sheets are applied, constituting an external edge band.

End panel consists of a framed panel and plinth base assembly. The framed panel assembly consists of Northern-grown Red Oak or maple hardwood rails and stiles with a veneered panel. The panel is 3/4" thick plain-sliced slip-matched Northern-grown Red Oak or maple routed on two sides and splined. The top rail is 2"H x 1" thick and side stiles are 1" x 1" with a 1" radius. The plinth base is composed of one piece of 5/4 solid Northern-grown Red Oak or maple 2-1/4" H x 1" thick. The plinth base receives a molded shape at the top which consists of a 1" radius ending in a 1/4" W reveal and is attached to the bottom of the frame panel assembly by means of three #8 x 3" long flat-head screws and wood glue. The bottom of the plinth receives two 7/8" diameter chrome adjustable glides located 1-1/4" from the plinth ends. End panel attaches to back panels by means of recessed metal fasteners and shoulder screws. Inside faces of end panels allow for shelf adjustment on 32mm center. Back panel is 3/4" thick, 45# density particleboard core of select Northern-grown Red Oak or maple face veneers. The top and bottom edge of the back panel receives 1.6mm solid oak or maple band. Unit has two full-depth fixed shelves with 3" diameter grommets and one pullout shelf for the keyboard. Space above the fixed shelves is 11".

END OF RANGE PAC STATION – Panel Mounted

This unit is designed to be attached to a double-faced end panel. Standard top is 1-3/16" thick, 3-ply, 45# density particleboard core, with a high-pressure laminate top surface .050" thick and a backing sheet .020" thick for balanced construction. The top receives a solid Northern-grown Red Oak or maple flush edge band 5/8" x 1-3/16" thick, radiused 1/2" to form a waterfall shape on the front and two sides with a 1/4" band on the back edge. Edge band is applied to the top after the laminate and backer sheets are applied, constituting an external edge band.

All panels are 3/4" thick, 45# density particleboard core of select Northern-grown Red Oak or maple face veneers. The base of the unit consists of tapered end panels, a back panel, an access panel for wire management and a removable front cover panel that provides access to the wire management. The back and access panel are 9-7/8" wide. The back panel receives a grommet at the base and the access panel receives a 6" wide opening. The front cover is solid and attaches to the access panel.

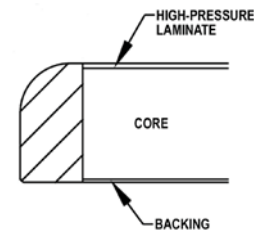

Abridge Flush Edge Band

Oak Catalog No.	Maple Catalog No.	Description	H x W x D	Wt. (lbs.)	Oak Price	Maple Price	
ABOPACEOR39S	ABMPACEOR39S	Free-Standing End-of-Range	39" x 23-1/2" x 20"	110	\$1,893	\$2,117	End-Of-Range Station
ABOPACEOR32S	ABMPACEOR32S	Free-Standing End-of-Range	32" x 23-1/2" x 20"	100	\$1,725	\$1,968	
ABOPACEPM39S	ABMPACEPM39S	Panel Mounted End-of-Range	39" x 22-1/2" x 18-1/8"	80	\$1,053	\$1,143	
ABOPACEPM32S	ABMPACEPM32S	Panel Mounted End-of-Range	32" x 22-1/2" x 18-1/8"	70	\$930	\$1,011	

End Panel Mounted PAC Station for Wood or Steel Shelving End Panels.

Note: Shelving End Panels are ordered separately and units MUST be attached.



Please specify Wood Finish (Table 1) and High-Pressure Laminate (Table 2). Details can be found on page GEN 4.

General Specifications

DICTIONARY STAND

Standard tops are 1-3/16" thick, 3-ply, 45# density particleboard core, with a high-pressure laminate top surface .050" thick and a backing sheet .020" thick for balanced construction. The desk top receives a solid Northern-grown Red Oak or maple flush external edge band 5/8" x 1-3/16" thick, radiused 1/2" to form a waterfall shape on the front and back. A 5/8" x 5/8" book retainer is positioned along the bottom edge of sloped top. End panel consists of a framed panel and plinth base assembly similar to all other Abridge end panels. Inside faces of end panels allow for shelf adjustment on 32mm center.

Back panel is 3/4" thick, 45# density particleboard core of select Northern-grown Red Oak or maple face veneers. The top and bottom edge of the back panel receives 1.6mm solid oak or maple band. Bottom shelf is stationary.

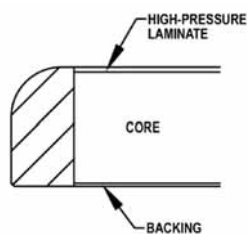

Abridge Flush Edge Band

ATLAS STAND

Standard tops are 1-3/16" thick, 3-ply, 45# density particleboard core, with a high-pressure laminate top surface .050" thick and a backing sheet .020" thick for balanced construction and receives a solid Northern-grown Red Oak or maple flush external edge band 5/8" x 1-3/16" thick, radiused 1/2" to form a waterfall shape on the front and back. A 5/8" x 5/8" book retainer is positioned along the bottom edge of sloped top. End panel consists of a framed panel and plinth base assembly similar to all other Abridge end panels. The bottom of the plinth receives two 7/8" diameter chrome adjustable glides located 1-1/4" from the plinth ends. Back panel is 3/4" thick, 45# density particleboard core of select Northern-grown Red Oak or maple face veneers. The top and bottom edge of the back panel receives 1.6mm solid oak or maple band. Each unit has five pullout shelves on nylon rollers. Stops on shelves prevent accidental removal. Shelves are 25-3/4"W x 23-7/8"D, with 3" between shelves. Children's height unit contains four pull-out shelves with 2-1/2" between shelves.

	Oak Catalog No.	Maple Catalog No.	Description	H x W x D	Wt. (lbs.)	Oak Price	Maple Price
	ABODCS162545S	ABMDCS162545S	Adult Dictionary Stand	45-1/2" x 24-3/8" x 16-1/2"	210	\$1,811	\$1,974
	ABODCS162538S	ABMDCS162538S	Youth Dictionary Stand	38-1/2" x 24-3/8" x 16-1/2"	200	\$1,811	\$1,974

Atlas Stand

	ABOATS293045S	ABMATS293045S	Adult Atlas Stand	45-1/2" x 28-3/8" x 29"	250	\$3,223	\$3,513
	ABOATS293038S	ABMATS293038S	Youth Atlas Stand	38-1/2" x 28-3/8" x 29"	240	\$3,223	\$3,513

Please specify Wood Finish (Table 1) and High-Pressure Laminate (Table 2).
Details can be found on page GEN 4.

Oak Catalog No.	Maple Catalog No.	Description	Wt. (lbs.)	Oak Price	Maple Price
<u>To Cover ONE UNIT</u>					
ABOCTW10SFC1S	ABMCTW10SFC1S	10"D, Single-Faced	11	\$277	\$291
ABOCTW12SFC1S	ABMCTW12SFC1S	12"D, Single-Faced	14	\$281	\$295
ABOCTW20DFC1S	ABMCTW20DFC1S	20"D, Double-Faced	23	\$393	\$413
ABOCTW24DFC1S	ABMCTW24DFC1S	24"D, Double-Faced	27	\$438	\$460
<u>To Cover TWO UNITS</u>					
ABOCTW10SFC2S	ABMCTW10SFC2S	10"D, Single-Faced	22	\$366	\$384
ABOCTW12SFC2S	ABMCTW12SFC2S	12"D, Single-Faced	28	\$389	\$408
ABOCTW20DFC2S	ABMCTW20DFC2S	20"D, Double-Faced	46	\$551	\$578
ABOCTW24SFC2S	ABMCTW24SFC2S	24"D, Double-Faced	54	\$693	\$727
<u>To Cover THREE UNITS</u>					
ABOCTW10SFC3S	ABMCTW10SFC3S	10"D, Single-Faced	33	\$478	\$502
ABOCTW12SFC3S	ABMCTW12SFC3S	12"D, Single-Faced	42	\$510	\$536
ABOCTW20DFC3S	ABMCTW20DFC3S	20"D, Double-Faced	69	\$695	\$729
ABOCTW24DFC2S	ABMCTW24DFC2S	24"D, Double-Faced	81	\$733	\$770
<u>To Cover FOUR UNITS</u>					
ABOCTW10SFC4S	ABMCTW10SFC4S	10"D, Single-Faced	44	\$730	\$767
ABOCTW12SFC4S	ABMCTW12SFC4S	12"D, Single-Faced	56	\$775	\$814
ABOCTW20DFC4S	ABMCTW20DFC4S	20"D, Double-Faced	92	\$1,087	\$1,142
ABOCTW24SFC4S	ABMCTW24SFC4S	24"D, Double-Faced	108	\$1,170	\$1,228
<u>To Cover FIVE UNITS</u>					
ABOCTW10SFC5S	ABMCTW10SFC5S	10"D, Single-Faced	55	\$843	\$886
ABOCTW12SFC5S	ABMCTW12SFC5S	12"D, Single-Faced	70	\$899	\$944
ABOCTW20DFC5S	ABMCTW20DFC5S	20"D, Double-Faced	115	\$1,245	\$1,307
ABOCTW24DFC5S	ABMCTW24DFC5S	24"D, Double-Faced	135	\$1,426	\$1,497
<u>To Cover SIX UNITS</u>					
ABOCTW10SFC6S	ABMCTW10SFC6S	10"D, Single-Faced	66	\$953	\$1,001
ABOCTW12SFC6S	ABMCTW12SFC6S	12"D, Single-Faced	84	\$1,020	\$1,071
ABOCTW20DFC6S	ABMCTW20DFC6S	20"D, Double-Faced	138	\$1,389	\$1,458
ABOCTW24DFC6S	ABMCTW24DFC6S	24"D, Double-Faced	162	\$1,464	\$1,538
<u>To Cover SEVEN UNITS</u>					
ABOCTW10SFC7S	ABMCTW10SFC7S	10"D, Single-Faced	77	\$1,229	\$1,291
ABOCTW12SFC7S	ABMCTW12SFC7S	12"D, Single-Faced	98	\$1,303	\$1,368
ABOCTW20DFC7S	ABMCTW20DFC7S	20"D, Double-Faced	161	\$1,780	\$1,869
ABOCTW24DFC7S	ABMCTW24DFC7S	24"D, Double-Faced	189	\$1,902	\$1,997
<u>To Cover EIGHT UNITS</u>					
ABOCTW10SFC8S	ABMCTW10SFC8S	10"D, Single-Faced	88	\$1,319	\$1,385
ABOCTW12SFC8S	ABMCTW12SFC8S	12"D, Single-Faced	112	\$1,409	\$1,479
ABOCTW20DFC8S	ABMCTW20DFC8S	20"D, Double-Faced	184	\$1,941	\$2,038
ABOCTW24DFC8S	ABMCTW24DFC8S	24"D, Double-Faced	216	\$2,156	\$2,264
<u>To Cover NINE UNITS</u>					
ABOCTW10SFC9S	ABMCTW10SFC9S	10"D, Single-Faced	99	\$1,432	\$1,503
ABOCTW12SFC8S	ABMCTW12SFC9S	12"D, Single-Faced	126	\$1,530	\$1,606
ABOCTW20DFC8S	ABMCTW20DFC9S	20"D, Double-Faced	207	\$2,085	\$2,189
ABOCTW24DFC8S	ABMCTW24DFC9S	24"D, Double-Faced	243	\$2,196	\$2,306

Note: Single-Faced Tops are banded on both ends and on the front edge only. Back edge is not banded.
Double-Faced Tops are banded on both ends and on the front and back edges.

Please specify Wood Finish (Table 1) and High-Pressure Laminate (Table 2). Details can be found on page GEN 4.

Oak Catalog No.	Maple Catalog No.	Description	Wt. (lbs.)	Oak Price	Maple Price
<i>To Cover ONE UNIT</i>					
ABOCTS10SFC1S	ABMCTS10SFC1S	10"D, Single-Faced	11	\$302	\$317
ABOCTS12SFC1S	ABMCTS12SFC1S	12"D, Single-Faced	14	\$304	\$319
ABOCTS20DFC1S	ABMCTS20DFC1S	20"D, Double-Faced	23	\$425	\$446
ABOCTS24DFC1S	ABMCTS24DFC1S	24"D, Double-Faced	27	\$478	\$502
<i>To Cover TWO UNITS</i>					
ABOCTS10SFC2S	ABMCTS10SFC2S	10"D, Single-Faced	22	\$396	\$416
ABOCTS12SFC2S	ABMCTS12SFC2S	12"D, Single-Faced	28	\$421	\$442
ABOCTS20DFC2S	ABMCTS20DFC2S	20"D, Double-Faced	46	\$599	\$629
ABOCTS24SFC2S	ABMCTS24SFC2S	24"D, Double-Faced	54	\$751	\$788
<i>To Cover THREE UNITS</i>					
ABOCTS10SFC3S	ABMCTS10SFC3S	10"D, Single-Faced	33	\$517	\$543
ABOCTS12SFC3S	ABMCTS12SFC3S	12"D, Single-Faced	42	\$554	\$582
ABOCTS20DFC3S	ABMCTS20DFC3S	20"D, Double-Faced	69	\$755	\$793
ABOCTS24DFC2S	ABMCTS24DFC2S	24"D, Double-Faced	81	\$794	\$832
<i>To Cover FOUR UNITS</i>					
ABOCTS10SFC4S	ABMCTS10SFC4S	10"D, Single-Faced	44	\$796	\$836
ABOCTS12SFC4S	ABMCTS12SFC4S	12"D, Single-Faced	56	\$843	\$886
ABOCTS20DFC4S	ABMCTS20DFC4S	20"D, Double-Faced	92	\$1,125	\$1,181
ABOCTS24SFC4S	ABMCTS24SFC4S	24"D, Double-Faced	108	\$1,271	\$1,335
<i>To Cover FIVE UNITS</i>					
ABOCTS10SFC5S	ABMCTS10SFC5S	10"D, Single-Faced	55	\$911	\$957
ABOCTS12SFC5S	ABMCTS12SFC5S	12"D, Single-Faced	70	\$972	\$1,026
ABOCTS20DFC5S	ABMCTS20DFC5S	20"D, Double-Faced	115	\$1,353	\$1,421
ABOCTS24DFC5S	ABMCTS24DFC5S	24"D, Double-Faced	135	\$1,548	\$1,625
<i>To Cover SIX UNITS</i>					
ABOCTS10SFC6S	ABMCTS10SFC6S	10"D, Single-Faced	66	\$1,033	\$1,085
ABOCTS12SFC6S	ABMCTS12SFC6S	12"D, Single-Faced	84	\$1,112	\$1,168
ABOCTS20DFC6S	ABMCTS20DFC6S	20"D, Double-Faced	138	\$1,509	\$1,585
ABOCTS24DFC6S	ABMCTS24DFC6S	24"D, Double-Faced	162	\$1,590	\$1,669
<i>To Cover SEVEN UNITS</i>					
ABOCTS10SFC7S	ABMCTS10SFC7S	10"D, Single-Faced	77	\$1,311	\$1,376
ABOCTS12SFC7S	ABMCTS12SFC7S	12"D, Single-Faced	98	\$1,401	\$1,470
ABOCTS20DFC7S	ABMCTS20DFC7S	20"D, Double-Faced	161	\$1,949	\$2,046
ABOCTS24DFC7S	ABMCTS24DFC7S	24"D, Double-Faced	189	\$2,068	\$2,171
<i>To Cover EIGHT UNITS</i>					
ABOCTS10SFC8S	ABMCTS10SFC8S	10"D, Single-Faced	88	\$1,432	\$1,503
ABOCTS12SFC8S	ABMCTS12SFC8S	12"D, Single-Faced	112	\$1,530	\$1,607
ABOCTS20DFC8S	ABMCTS20DFC8S	20"D, Double-Faced	184	\$2,107	\$2,213
ABOCTS24DFC8S	ABMCTS24DFC8S	24"D, Double-Faced	216	\$2,343	\$2,460
<i>To Cover NINE UNITS</i>					
ABOCTS10SFC9S	ABMCTS10SFC9S	10"D, Single-Faced	99	\$1,553	\$1,630
ABOCTS12SFC8S	ABMCTS12SFC9S	12"D, Single-Faced	126	\$1,667	\$1,749
ABOCTS20DFC8S	ABMCTS20DFC9S	20"D, Double-Faced	207	\$2,264	\$2,377
ABOCTS24DFC8S	ABMCTS24DFC9S	24"D, Double-Faced	243	\$2,385	\$2,504

Note: Edge Band on long side only. Tops are designed to be inset between end panels. If edge bands are desired on short edges, please enter the part as a modification and specify which bands to be included.

To ensure that tops for steel shelving work with each manufacturer and top method, please specify the exact width and depth of tops. Add 15% for HPL on top and bottom (Steel Shelving ONLY).

Please specify Wood Finish (Table 1) and High-Pressure Laminate (Table 2). Details can be found on page GEN 4.

General Specifications

END PANELS

End panel consists of a framed panel and plinth base assembly. The framed panel assembly consists of Northern-grown Red Oak or Maple hardwood rails and stiles with a veneered panel. The panel is 3/4" thick plain sliced slip matched Northern-grown Red Oak or maple routed on two sides. The top rail is 2"H x 1" thick and side stiles are 1" x 1" with a 1" radius. The plinth base is composed of one piece of 5/4 solid Northern grown Red Oak or maple 2-1/4"H x 1" thick. The plinth base receives a molded shape at the top which consists of a 1" radius ending in a 1/4"W reveal and is attached to the bottom of the frame panel assembly by means of three #8 x 3" long flat-head screws and wood glue. End panels are not machined. No fastening hardware is provided with end panels.

End panels for steel shelving with continuous tops or canopy top inset are designed to have the canopy top "inset" between the end panels.

Note: Exact height and depth of panel must be specified when ordering.

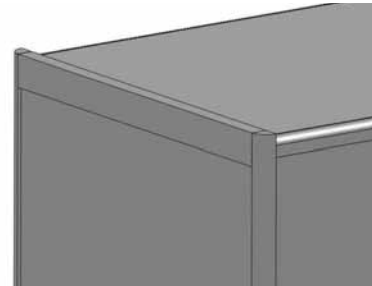

End Panel with Canopy Top Inset

Oak Catalog No.	Maple Catalog No.	Description	Wt. (lbs.)	Oak Price	Maple Price	
ABOEPSSFP4313S	ABMEPSSFP4313S	43-3/4" x 13-7/8"	14	\$434	\$456	Single-Faced End Panels
ABOEPSSFP4315S	ABMEPSSFP4315S	43-3/4" x 15-7/8"	16	\$445	\$467	
ABOEPSSFP6713S	ABMEPSSFP6713S	67-3/4" x 13-7/8"	21	\$496	\$521	
ABOEPSSFP6715S	ABMEPSSFP6715S	67-3/4" x 15-7/8"	26	\$513	\$539	
ABOEPSSFP7913S	ABMEPSSFP7913S	79-3/4" x 13-7/8"	25	\$556	\$584	
ABOEPSSFP7915S	ABMEPSSFP7915S	79-3/4" x 15-7/8"	30	\$575	\$603	
ABOEPSSFP8513S	ABMEPSSFP8513S	85-3/4" x 13-7/8"	28	\$589	\$618	
ABOEPSSFP8515S	ABMEPSSFP8515S	85-3/4" x 15-7/8"	33	\$607	\$638	
ABOEPSSFP9113S	ABMEPSSFP9113S	91-3/4" x 13-7/8"	29	\$625	\$657	
ABOEPSSFP9115S	ABMEPSSFP9115S	91-3/4" x 15-7/8"	35	\$654	\$687	

Oak Catalog No.	Maple Catalog No.	Description	Wt. (lbs.)	Oak Price	Maple Price	
ABOEPSDFP4324S	ABMEPSDFP4324S	43-3/4" x 24-3/8"	27	\$488	\$513	Double-Faced End Panels
ABOEPSDFP4328S	ABMEPSDFP4328S	43-3/4" x 28-3/8"	33	\$510	\$536	
ABOEPSDFP6724S	ABMEPSDFP6724S	67-3/4" x 24-3/8"	43	\$586	\$615	
ABOEPSDFP6728S	ABMEPSDFP6728S	67-3/4" x 28-3/8"	52	\$621	\$652	
ABOEPSDFP7924S	ABMEPSDFP7924S	79-3/4" x 24-3/8"	51	\$647	\$680	
ABOEPSDFP7928S	ABMEPSDFP7928S	79-3/4" x 28-3/8"	61	\$683	\$716	
ABOEPSDFP8524S	ABMEPSDFP8524S	85-3/4" x 24-3/8"	55	\$680	\$714	
ABOEPSDFP8528S	ABMEPSDFP8528S	85-3/4" x 28-3/8"	66	\$716	\$751	
ABOEPSDFP9124S	ABMEPSDFP9124S	91-3/4" x 24-3/8"	59	\$718	\$754	
ABOEPSDFP9128S	ABMEPSDFP9128S	91-3/4" x 28-3/8"	60	\$756	\$794	

Please specify Wood Finish (Table 1). Details can be found on page GEN 4.

General Specifications

CHAIR FRAME

The end frames are constructed of a framed panel and plinth base assembly. The framed panel assembly consists of solid Northern-grown Red Oak or maple hardwood rails and stiles with a veneered panel. The panel is 3/4" thick plain sliced slip matched Northern grown Red Oak or Maple routed on three sides. The top rail is 2"H x 1" thick and side stiles are 1" x 1" with a 1" radius. The plinth base is composed of one piece of 5/4 solid Northern-grown Red Oak or maple 2-1/4"H x 1" thick. The plinth base receives a molded shape at the top which consists of a 1" radius ending in a 1/4"W reveal and is attached to the bottom of the frame panel assembly by means of three #8 x 3" long flat-head screws and wood glue. The bottom of the plinth receives two 7/8" diameter chrome adjustable glides located 1-1/4" from the plinth ends.

The front stretcher and front seat rail are 3"W x 1" thick Northern-grown Red Oak or maple. The back seat rail is 2-3/4"W x 1" thick solid red oak or maple. The cross stretcher and seat rails are mortised, tenoned, and glued into the side frames.

UPHOLSTERED SEAT AND BACK

The seat and back frame are a single piece of 3/4" bent plywood. The seat portion is fitted with a Dimatrol Webbing and then covered with black cambric fabric for comfort. This is then covered with 3-1/2" foam, which is also used on the chair back. The entire seat and back assembly is covered with the specified upholstery fabric except for the underside of the seat which is covered with a black cambric fabric. Brodart upholstery materials meet requirements of the following fire codes:

Calif. Technical Bulletin #117 (sec. E part 1); CS-191-53 class 1.

Catalog No.	Description	Overall H x W x D	Wt. (lbs.)	COM Price	Wood/G1 Price	Grade 2 Price	Grade 3 Price	Grade 4 Price	Grade 5 Price
-------------	-------------	-------------------	------------	-----------	---------------	---------------	---------------	---------------	---------------

One Seat Lounge, Oak Wood

ABOLNG1SS	Lounge	31" x 27" x 29-1/2"	65	\$2,887	\$2,783	\$3,506	\$3,752	\$4,014	\$4,295
ABOLNG1SRTS	Lounge w/Right Table Arm	31" x 27" x 29-1/2"	70	\$3,112	\$3,010	\$3,780	\$4,044	\$4,326	\$4,630
ABOLNG1SLTS	Lounge w/Left Table Arm	31" x 27" x 29-1/2"	70	\$3,112	\$3,010	\$3,780	\$4,044	\$4,326	\$4,630

One Seat Lounge, Maple Wood

ABMLNG1SS	Lounge	31" x 27" x 29-1/2"	65	\$3,015	\$2,905	\$3,660	\$3,918	\$4,190	\$4,485
ABMLNG1SRTS	Lounge w/Right Table Arm	31" x 27" x 29-1/2"	70	\$3,248	\$3,130	\$3,944	\$4,219	\$4,516	\$4,831
ABMLNG1SLTS	Lounge w/Left Table Arm	31" x 27" x 29-1/2"	70	\$3,248	\$3,130	\$3,944	\$4,219	\$4,516	\$4,831

Fabric Requirements: 3 yards per chair, Non-directional, 54" wide.

One Seat



Two Seat Lounge, Oak Wood

ABOLNG2SS	Lounge	31" x 51" x 29-1/2"	110	\$4,185	\$3,986	\$5,022	\$5,374	\$5,750	\$6,153
ABOLNG2SRTS	Lounge w/Right Table Arm	31" x 51" x 29-1/2"	115	\$4,417	\$4,206	\$5,301	\$5,672	\$6,067	\$6,493
ABOLNG2SLTS	Lounge w/Left Table Arm	31" x 51" x 29-1/2"	115	\$4,417	\$4,206	\$5,301	\$5,672	\$6,067	\$6,493

Two Seat Lounge, Maple Wood

ABMLNG2SS	Lounge	31" x 51" x 29-1/2"	110	\$4,333	\$4,127	\$5,201	\$5,564	\$5,954	\$6,371
ABMLNG2SRTS	Lounge w/Right Table Arm	31" x 51" x 29-1/2"	115	\$4,567	\$4,350	\$5,481	\$5,865	\$6,276	\$6,714
ABMLNG2SLTS	Lounge w/Left Table Arm	31" x 51" x 29-1/2"	115	\$4,567	\$4,350	\$5,481	\$5,865	\$6,276	\$6,714

Fabric Requirements: 6 yards per chair, Non-directional, 54" wide.

Two Seat



Bariatric Lounge, Oak Wood

ABOLNGBAS	Lounge	31" x 42" x 29-1/2"	110	\$4,374	\$4,166	\$5,249	\$5,617	\$6,009	\$6,431
ABOLNGBARTS	Lounge w/Right Table Arm	31" x 42" x 29-1/2"	115	\$4,605	\$4,387	\$5,528	\$5,916	\$6,328	\$6,772
ABOLNGBALTS	Lounge w/Left Table Arm	31" x 42" x 29-1/2"	115	\$4,605	\$4,387	\$5,528	\$5,916	\$6,328	\$6,772

Bariatric Lounge, Maple Wood

ABMLNGBAS	Lounge	31" x 42" x 29-1/2"	110	\$4,522	\$4,307	\$5,427	\$5,807	\$6,212	\$6,649
ABMLNGBARTS	Lounge w/Right Table Arm	31" x 42" x 29-1/2"	115	\$4,755	\$4,528	\$5,706	\$6,104	\$6,532	\$6,989
ABMLNGBALTS	Lounge w/Left Table Arm	31" x 42" x 29-1/2"	115	\$4,755	\$4,528	\$5,706	\$6,104	\$6,532	\$6,989

Fabric Requirements: 5 yards per chair, Non-directional, 54" wide.

Bariatric Lounge



Please specify Wood Finish (Table 1), High-Pressure Laminate; if applicable (Table 2) and Upholstery (Table 5). Details can be found on pages GEN 4 and GEN 5.

General Specifications

TABLETOP

Tabletop is 1-3/16" thick, 3-ply 45# density particleboard, with a high-pressure laminate top surface .050" thick and a backing sheet .020" thick for balanced construction. Edges are solid Northern-grown Red Oak or maple. Top receives an external solid drop edge Northern-grown Red Oak or maple band 5/8" x 1-5/8" thick, radiused 1/2" to form a waterfall shape.

APRON (OPTIONAL)

A 4"H x 1" thick solid Northern-grown Red Oak or maple apron is fitted between the legs and behind the extended tabletop edge band. Starting 1/2" in from each end, the apron receives a radius that peaks at 2" in the center. The ends of each apron receive a 1/2" radius. Aprons are attached to the table using wood cleats screwed to the underside of the tabletop. Aprons on round tables are fitted between the legs and follow the curvature of the edge band.



Note: Aprons are not available for trapezoid shaped tables or Pedestal Base tables.

LEG

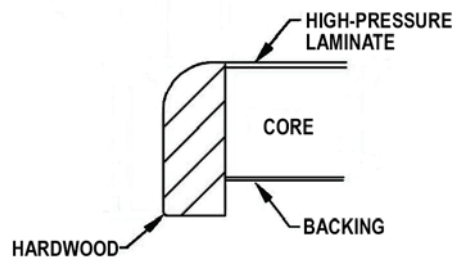
The leg is glued up 2-1/4" solid Northern-grown Red Oak or maple. The leg is molded into a triangle shape with the front face receiving a 2" radius and outside edges receiving a 1/2" radius that tapers to a 90° right angle. A 1/4" wide x 1/16" deep horizontal vein line is routed 2" up from the bottom of the leg. A 1/8" chamfer is placed at the bottom of the leg. Each leg receives a 1-1/2" diameter, adjustable glide mounted in a recessed tee-nut which is further recessed into the leg by means of a counter-sink boring which accepts the upper two-thirds of the glide. Legs attach to tabletops by means of a 5" square x 5/16" thick cold-rolled steel plate. The plate is attached to the leg by a 5/16" x 2-1/2" machine bolt engaging a 5/8" diameter barrel nut inserted into the leg. The assembled leg is attached to the tabletop by five 5/16" x 1" machine bolts engaging internal and external threaded bushings embedded in the underside of the tabletop. Leg plates are positioned behind and hidden by the extended table edge band.



Abridge Drop Edge Band

Oak Catalog No.	Maple Catalog No.	Description	H x W x D	Wt. (lbs.)	Oak Price	Maple Price	
ABOT30RD16ARTWS	ABMT30RD16ARTWS	Round Table	16"H x 30" Diameter	60	\$1,507	\$1,688	<p style="text-align: right;">Round Table</p> 
ABOT36RD16ARTWS	ABMT36RD16ARTWS	Round Table	16"H x 36" Diameter	60	\$1,557	\$1,743	
ABOT242422ARTWS	ABMT242422ARTWS	Square End Table	22" x 24" x 24"	45	\$1,111	\$1,242	<p style="text-align: right;">Square Table</p> 
ABOT303016ARTWS	ABMT303016ARTWS	Square Lounge Table	16" x 30" x 30"	51	\$1,378	\$1,545	
ABOT243022ARTWS	ABMT243022ARTWS	Rectangular End Table	22" x 30" x 24"	48	\$1,160	\$1,299	<p style="text-align: right;">Rectangular Table</p> 
ABOT244816ARTWS	ABMT244816ARTWS	Rectangular Lounge Table	16" x 48" x 24"	46	\$1,564	\$1,750	

Please specify Wood Finish (Table 1) and High-Pressure Laminate (Table 2). Details can be found on page GEN 4.
 Note: Optional Wood Aprons for Tables are located on page ABR 21.

The Chancellor's Collection



2017 Price List and Specifications

Brodart Co. Contract Furniture - Made in USA

280 North Road, Clinton County Industrial Park • McElhattan, PA 17748

Toll-Free: 888-521-1884 • E-Mail: furniture@brodart.com • www.brodartfurniture.com

General Specifications

DESKTOP

Standard desk top is 1-3/16" thick, 3-ply, 45# density particleboard core with a top surface of high-pressure laminate .050" thick. A backing sheet not less than .020" thick is also applied for balanced construction. High-pressure laminate has a lo-glare finish resistant to scratches, fading and staining in accordance with NEMA standards. Tops receive a 1" W x 1-3/16" thick solid-oak undercut chamfered edge band; applied to top core after lamination of the face plastic. The edge band is beveled at a 39° angle with a 3/8" radius bullnose at the leading edge. A 1/4" thick, solid Northern-grown red oak edge band is applied to the remaining three sides, with top and bottom edges radiused to 1/8". All edges are applied to the desk top after the top and bottom laminate sheets are applied, constituting an external edge band. Desk tops are positioned over the end panels of the desk module, flush with the outside edges of the end panels.

DESK END PANELS

Desk module end panels are 1" thick, 3-ply 45# density particleboard core with select plain-sliced oak veneer on both sides. Exposed edges are externally banded with a 1" x 1/16" thick, Northern-grown oak edge band. The end panels and front panel are joined and secured with 3/4" x 3/4" thick solid hardwood cleats screwed to the inside surfaces of the panels. The bottom of each end panel receives two adjustable glides to allow leveling of the individual units. Each end panel receives a 3" diameter egress and grommet to provide for wire passage.

FRONT PANEL

The front panel is 3/4" thick, 45# density particleboard core comprised of select plain-sliced, slip-matched oak veneer on the inside face. Veneer on outside face is a combination of plain-sliced ash veneer surrounded by rift-cut oak veneer to form a framed appearance. The "frame" is composed of 3-1/4"W rift-cut, oak veneer strips along both vertical edges and the bottom edge, and a 3-1/4"W rift cut oak veneer strip at the top edge shaped to form an internal arc. Panels are externally banded with 1.6mm solid oak on all vertical and horizontal edges, and all edges are eased. The front incorporates a 6"H x 3/4"D recessed and ebonized toe space at the bottom of the panel. The front panel is positioned over the end panels of the desk module, flush with the outside edges of the end panels. Double wide units have two front panels to give the appearance of two individual units.

DESK DIMENSIONS

Standing-Height Desk, overall:

39-1/4"H x 35"W x 30-3/8"D or 39-1/4"H x 70"W x 30-3/8"D.

Sitting-Height Desk, overall:

32-1/4"H x 35"W x 30-3/8"D or 32-1/4"H x 70"W x 30-3/8"D.

ADJUSTABLE WORK SURFACE

Work surfaces are 1-3/16" thick, 3-ply particleboard core, including a top surface of .050" thick, high-pressure laminate with a backing sheet not less than .020" thick for balanced construction. High-pressure laminate has a lo-glare finish resistant to scratches, fading and staining in accordance with NEMA standards. The exposed edge receives a 1/4" thick, solid Northern-grown red oak internal edge band in straight design. The back edge of the work surface has a black strip, 1-1/2"W, which projects above the work surface 1/4" to act as a retainer. The work surface is 24-1/2"D and is positioned 1-1/2" away from the front panel, creating a cord drop space. Adjustable work surfaces are available in single-wide standing-height desks. Work surfaces in standing-height desks (catalog numbers 73-012-S00) may be positioned at heights of 36", 32" or 27".

SHELVES

Shelves are constructed of 7-ply, furniture-grade hardwood, and veneer-core plywood with plain-sliced solid-oak face veneer. Fronts are banded with solid oak. Exposed edges receive a 1.6mm thick solid-oak edge band.

DRAWERS

Drawers are constructed of solid hardwood with 1/4" thick wood bottom panel. Drawers have 3-ply particleboard fronts with select oak face veneers. Box drawers have extension slides with 100# load capacity. File drawers have full-extension slides with 100# load capacity.

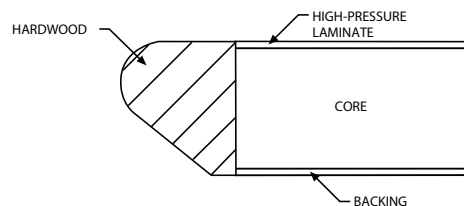

Chancellor's Series Edge Band

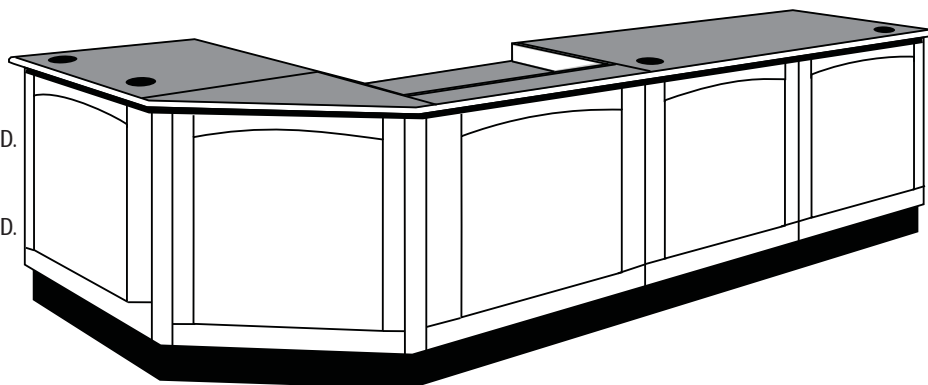

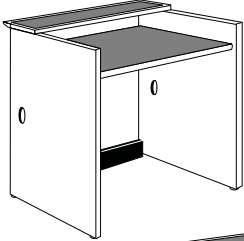
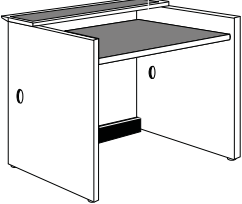
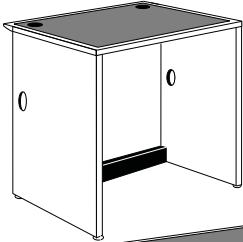
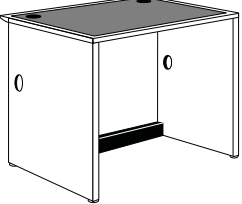
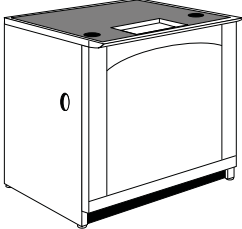
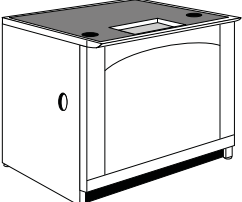
Oak Catalog No.	Maple Catalog No.	Description	H x W x D	Wt. (lbs.)	Oak Price	Maple Price	Standing	Sitting
CH2-012-S00 OAK	CH2-012-S00 MAP	Standing Height Desk with Patron Service Ledge Inside dimensions: 33"W x 26-3/4"D. The 7-7/8" patron ledge is at a height of 39-3/16"H. Note: Adjustable-height work surface may be positioned at heights of 36", 32" or 27".	39-3/16" x 35" x 30"	140	\$3,254	\$3,547		Single-Wide Desk with Patron Service Ledge
CH2-E12-S00 OAK	CH2-E12-S00 MAP	Sitting Height Desk with Patron Service Ledge Inside dimensions: 33"W x 26-3/4"D. The 7-7/8" patron ledge is at a height of 32-3/16"H. Note: Work surface is fixed at 27"H.	32-3/16" x 35" x 30"	125	\$3,097	\$3,376		
CH2-014-S00 OAK	CH2-014-S00 MAP	Standing Height Desk without Patron Service Ledge Inside dimensions: 33"W x 26-3/4"D. The work surface is at 39-3/16"H. Two 3" diameter grommets are located in the work surface.	39-3/16" x 35" x 30"	135	\$2,896	\$3,157		Single-Wide Desk without Patron Service Ledge
CH2-E14-S00 OAK	CH2-E14-S00 MAP	Sitting Height Desk without Patron Service Ledge Inside dimensions: 33"W x 26-3/4"D. The work surface is at 32-3/16"H. Two 3" diameter grommets are located in the work surface.	32-3/16" x 35" x 30"	120	\$2,680	\$2,922		
CH2-015-S00 OAK	CH2-015-S00 MAP	Standing Height Book Return Unit Inside dimensions: 33"W x 26-3/4"D. The work surface is at 39-3/16"H. Unit has a 5"H x 12"W finished opening centered in the front panel for passage of books and a book chute to direct the books over a mobile depressible book truck. (Depressible book truck not included). Two 3" diameter grommets are located in the work surface.	39-3/16" x 35" x 30"	135	\$2,819	\$3,073		Book Return Unit
CH2-E15-S00 OAK	CH2-E15-S00 MAP	Sitting Height Book Return Unit Inside dimensions: 33"W x 26-3/4"D. The work surface is at 32-3/16"H. Unit has a 5"H x 12"W finished opening centered in the front panel for passage of books and a book chute to direct the books over a mobile depressible book truck. (Depressible book truck not included). Two 3" diameter grommets are located in the work surface.	32-3/16" x 35" x 30"	120	\$2,671	\$2,911		

Please specify Wood Finish (Table 1) and High-Pressure Laminate (Table 2). Details can be found on page GEN 4.

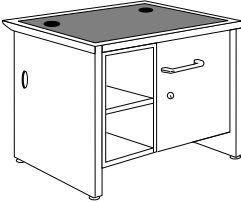
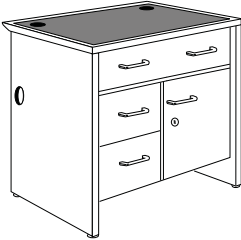
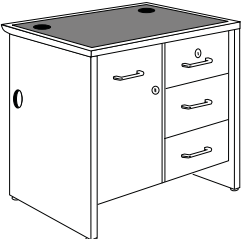
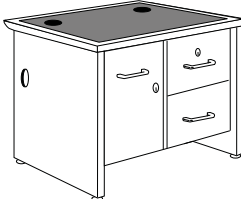
Standing	Sitting	Oak Catalog No.	Maple Catalog No.	Description	H x W x D	Wt. (lbs.)	Oak Price	Maple Price
Cupboard and Open Shelf		CH2-121-S00 OAK	CH2-121-S00 MAP	Standing Height Cupboard and Open Shelf	39-3/16" x 35" x 30"	175	\$5,132	\$5,595
				This unit has one fixed and two adjustable shelves. A hidden drawer is positioned above the lockable storage compartment. Two 3" diameter grommets are located in the work surface.				
		CH2-E21-S00 OAK	CH2-E21-S00 MAP	Sitting Height Cupboard	32-3/16" x 35" x 30"	160	\$4,806	\$5,239
				This unit has one fixed and one adjustable shelf. A hidden drawer is positioned above the lockable storage compartment. Two 3" diameter grommets are located in the work surface.				
Full Width Drawer, Cupboard and Drawers		CH2-122-S00 OAK	CH2-122-S00 MAP	Standing Height Full Width Drawer, Cupboard and Drawers	39-3/16" x 35" x 30"	225	\$6,872	\$7,490
				This unit has one full-width drawer, two file drawers, and a lockable storage compartment. Two 3" diameter grommets are located in the work surface. Note: Available in 39"H only.				
Cupboard and Drawer Unit		CH2-123-S00 OAK	CH2-123-S00 MAP	Standing Height Cupboard and Drawer Unit	39-3/16" x 35" x 30"	225	\$6,134	\$6,687
				This unit has one locking box drawer and two file drawers. Cupboard section has two adjustable shelves and locking door on hinges. Two 3" diameter grommets are located in the work surface.				
		CH2-E23-S00 OAK	CH2-E23-S00 MAP	Sitting Height Cupboard and Drawer Unit	32-3/16" x 35" x 30"	205	\$5,605	\$6,110
				This unit has one locking file drawer and one file drawer. Cupboard section has one adjustable shelf and locking door on hinges. Two 3" diameter grommets are located in the work surface.				

Please specify Wood Finish (Table 1) and High-Pressure Laminate (Table 2). Details can be found on page GEN 4.

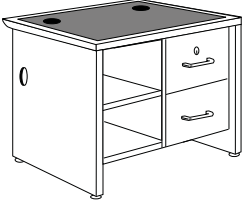
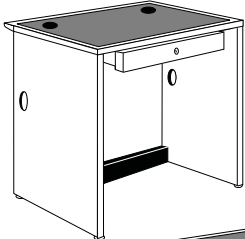
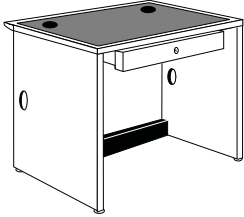
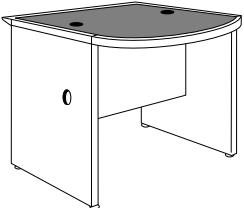
Oak Catalog No.	Maple Catalog No.	Description	H x W x D	Wt. (lbs.)	Oak Price	Maple Price	Standing	Sitting
CH2-124-S00 OAK	CH2-124-S00 MAP	Standing Height Open Shelf and Drawer Unit This unit has one lockable box drawer and two file drawers. Shelf section has two adjustable shelves, and one fixed base shelf. Two 3" diameter grommets are located in the work surface.	39-3/16" x 35" x 30"	200	\$5,692	\$6,204	Open Shelf and Drawer Unit	
								
CH2-E24-S00 OAK	CH2-E24-S00 MAP	Sitting Height Open Shelf and Drawer Unit This unit has one lockable box drawer and one file drawer. Shelf section has one adjustable shelf, and one fixed base shelf. Two 3" diameter grommets are located in the work surface.	32-3/16" x 35" x 30"	125	\$5,217	\$5,687		
								
CH2-131-S00 OAK	CH2-131-S00 MAP	Standing Height Cash Drawer Unit Inside dimensions: 33"W x 26-3/4"D. The work surface is at 39-3/16"H. Desk has locking drawer with a coin and currency tray. Two 3" diameter grommets are located in the work surface.	39-3/16" x 35" x 30"	150	\$4,014	\$4,375	Cash Drawer Unit	
								
CH2-E31-S00 OAK	CH2-E31-S00 MAP	Sitting Height Cash Drawer Unit Inside dimensions: 33"W x 26-3/4"D. The work surface is at 32-3/16"H. Desk has locking drawer with a coin and currency tray. Two 3" diameter grommets are located in the work surface.	32-3/16" x 35" x 30"	135	\$3,844	\$4,190		
								
CH2-E32-S00 OAK	CH2-E32-S00 MAP	Sitting Height ADA Station The ADA transaction station is designed to provide wheelchair access on the patrons' side. The knee space depth on the patrons' side is 22-1/4" and on the staff side is 16". Two 3" diameter grommets are located in the work surface. One 3-1/2" diameter egress with sleeve is located in each end panel for wire passage.	32-3/16" x 35" x 40-1/2"	185	\$3,016	\$3,288	ADA Station	
								

Please specify Wood Finish (Table 1) and High-Pressure Laminate (Table 2). Details can be found on page GEN 4.

Standing	Sitting	Oak Catalog No.	Maple Catalog No.	Description	H x W x D	Wt. (lbs.)	Oak Price	Maple Price
		CH2-133-S00 OAK	CH2-133-S00 MAP	Standing Height Full Width Drawer Unit	39-3/16" x 35" x 30"	160	\$4,115	\$4,486

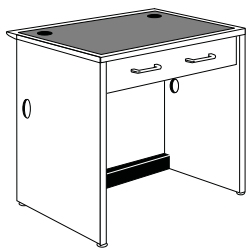

This drawer unit has a full-width drawer 10"H x 33"W x 18-3/4"D. Two 3" diameter grommets are located in the work surface.
Note: Available in 39-3/16"H only.

		CH2-135-S00 OAK	CH2-135-S00 MAP	Standing Height Full Width Drawer and Cupboard Unit	39-3/16" x 35" x 30"	220	\$4,527	\$4,934
--	--	-----------------	-----------------	--	----------------------	-----	---------	---------

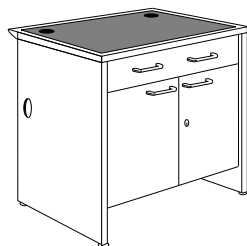

This unit has a full-width drawer 10"H x 33"W x 18-3/4"D. Also, one fixed and one adjustable, full-depth shelf. Hinged doors have a catch, lock and door pulls. Two 3" diameter grommets are located in the work surface.
Note: Available in 39-3/16"H only.

		CH2-172-S00 OAK	CH2-172-S00 MAP	Standing Height Discharge Unit	39-3/16" x 35" x 30"	165	\$4,278	\$4,663
--	--	-----------------	-----------------	--------------------------------	----------------------	-----	---------	---------

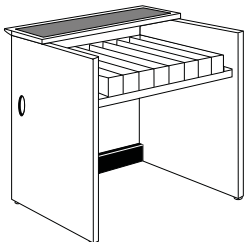

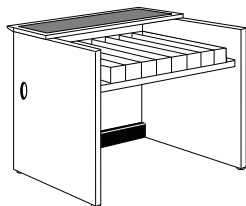

These units have a full-width well with seven removable wood trays for 5"H x 3"W cards. The 7-7/8" patron ledge is at a height of 39-3/16"H.
Note: Standing-height roll unders do not work with this unit.

		CH2-E72-S00 OAK	CH2-E72-S00 MAP	Sitting Height Discharge Unit	32-3/16" x 35" x 30"	145	\$4,061	\$4,426
--	--	-----------------	-----------------	-------------------------------	----------------------	-----	---------	---------

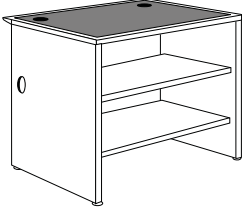
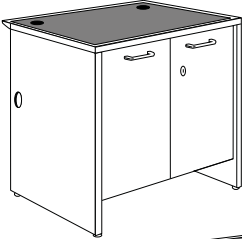
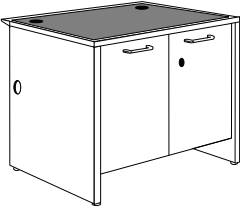

These units have a full-width well with seven removable wood trays for 5"H x 3"W cards. The 7-7/8" patron ledge is at a height of 32-3/16"H.

Please specify Wood Finish (Table 1) and High-Pressure Laminate (Table 2). Details can be found on page GEN 4.

Oak Catalog No.	Maple Catalog No.	Description	H x W x D	Wt. (lbs.)	Oak Price	Maple Price	Standing	Sitting
CH2-174-S00 OAK	CH2-174-S00 MAP	Standing Height Open Shelf Unit This unit has a full-depth fixed base shelf and two full-depth adjustable shelves. Two 3" diameter grommets are located in the work surface.	39-3/16" x 35" x 30"	175	\$3,301	\$3,598		Open Shelf Unit
CH2-E74-S00 OAK	CH2-E74-S00 MAP	Sitting Height Open Shelf Unit This unit has a full-depth fixed base shelf and two full-depth adjustable shelves. Two 3" diameter grommets are located in the work surface.	32-3/16" x 35" x 30"	155	\$2,974	\$3,241		
CH2-176-S00 OAK	CH2-176-S00 MAP	Standing Height Cupboard Unit This unit has a full-depth fixed base shelf and two full-depth adjustable shelves. Hinged doors have a catch, lock and door pulls. Two 3" diameter grommets are located in the work surface.	39-3/16" x 35" x 30"	200	\$3,993	\$4,352		Cupboard Unit
CH2-E76-S00 OAK	CH2-E76-S00 MAP	Sitting Height Cupboard Unit This unit has a full-depth fixed base shelf and one full-depth adjustable shelf. Hinged doors have a catch, lock and door pulls. Two 3" diameter grommets are located in the work surface.	32-3/16" x 35" x 30"	180	\$3,813	\$4,156		
CH2-234-S00 OAK	CH2-234-S00 MAP	Standing Height Full Width Drawer and Open Shelves This unit has a full-width drawer 10"H x 33"W x 18-3/4"D. Also, one fixed and one adjustable, full-depth shelf. Two 3" diameter grommets are located in the work surface.	39-3/16" x 35" x 30"	180	\$3,914	\$4,267		Full Width Drawer and Open Shelves
CH2-E34-S00 OAK	CH2-E34-S00 MAP	Sitting Height Full Width Drawer and Open Shelves This unit has a full-width drawer 10"H x 33"W x 18-3/4"D. Also, one fixed and one adjustable, full-depth shelf. Two 3" diameter grommets are located in the work surface.	32-3/16" x 35" x 30"	165	\$3,690	\$4,022		

Please specify Wood Finish (Table 1) and High-Pressure Laminate (Table 2). Details can be found on page GEN 4.

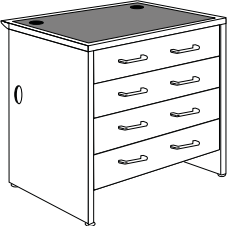
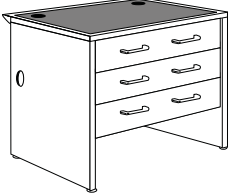
Standing	Sitting	Oak Catalog No.	Maple Catalog No.	Description	H x W x D	Wt. (lbs.)	Oak Price	Maple Price
		CH2-236-S00 OAK	CH2-236-S00 MAP	Standing Height Media Storage Unit This unit has four full-width drawers 8-1/2"H x 33"W x 24"D with each containing five compartments for media storage.	39-3/16" x 35" x 30"	225	\$5,437	\$5,926
		CH2-E36-S00 OAK	CH2-E36-S00 MAP	Sitting Height Media Storage Unit This unit has three full-width drawers 8-1/2"H x 33"W x 24"D with each containing five compartments for media storage.	32-3/16" x 35" x 30"	205	\$5,040	\$5,494
								

Please specify Wood Finish (Table 1) and High-Pressure Laminate (Table 2). Details can be found on page GEN 4.

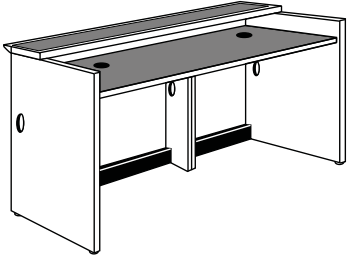
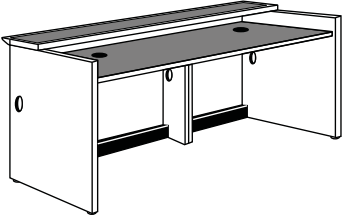
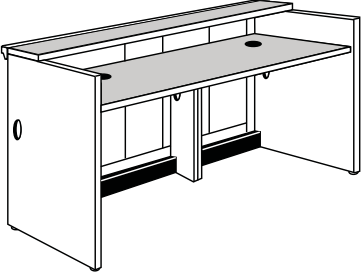
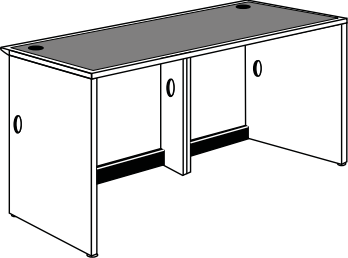
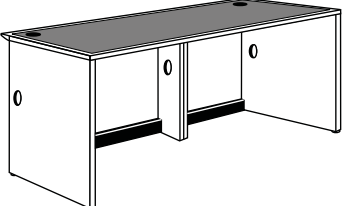
Oak Catalog No.	Maple Catalog No.	Description	H x W x D	Wt. (lbs.)	Oak Price	Maple Price	Standing	Sitting
CH2-011-S00 OAK	CH2-011-S00 MAP	Standing Height Double-Wide Desk with Patron Service Ledge Work Surface at 35"H Inside dimensions are 68"W x 26-3/4"D. The 7-7/8"D patron ledge is at a height of 39-3/16". Two 3" diameter grommets are located in the work surface. Note: Standing-height roll unders do not work with this unit.	39-3/16" x 70" x 30"	245	\$4,695	\$5,117		Double-Wide Desk with Patron Service Ledge,
								
CH2-E11-S00 OAK	CH2-E11-S00 MAP	Sitting Height Double-Wide Desk with Patron Service Ledge Work Surface at 28"H Inside dimensions are 68"W x 26-3/4"D. The 7-7/8"D patron ledge is at a height of 32-3/16". Two 3" diameter grommets are located in the work surface.	32-3/16" x 70" x 30"	210	\$4,698	\$5,122		
								
CH2-011-SEA OAK	CH2-011-SEA MAP	Standing Height Double-Wide Desk with Patron Service Ledge Work Surface at 28"H Inside dimensions are 68"W x 26-3/4"D. The 7-7/8"D patron ledge is at a height of 39-3/16". Two 3" diameter grommets are located in the work surface. Note: Standing-height roll unders do not work with this unit.	39-3/16" x 70" x 30"	245	\$4,967	\$5,414		
								
CH2-013-S00 OAK	CH2-013-S00 MAP	Standing Height Double-Wide Desk without Patron Service Ledge Inside dimensions are 68"W x 26-3/4"D. The work surface is at 39-3/16" H. Two 3" diameter grommets are located in the work surface.	39-3/16" x 70" x 30"	230	\$4,499	\$4,905		Double-Wide Desk without Patron Service Ledge
								
CH2-E13-S00 OAK	CH2-E13-S00 MAP	Sitting Height Double-Wide Desk without Patron Service Ledge Inside dimensions are 68"W x 26-3/4"D. The work surface is at 32-3/16" H. Two 3" diameter grommets are located in the work surface.	32-3/16" x 70" x 30"	195	\$4,287	\$4,673		
								

Please specify Wood Finish (Table 1) and High-Pressure Laminate (Table 2). Details can be found on page GEN 4.

Standing	Sitting	Oak Catalog No.	Maple Catalog No.	Description	H x W x D	Wt. (lbs.)	Oak Price	Maple Price
Double-Wide Work Desk	Double Pedestal	CH2-E37-S00 OAK	CH2-E37-S00 MAP	Sitting Height Double-Wide Double Pedestal Work Desk	32-3/16" x 70" x 30"	260	\$9,461	\$10,313

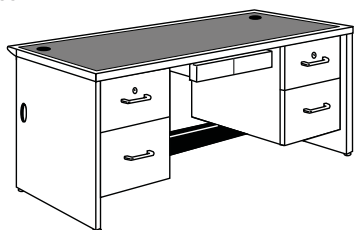

Inside dimensions are 68"W x 26-3/4"D.
 This unit has two drawer pedestals, one mounted on each side consisting of one locking drawer at top; one file drawer with hanging file rack at bottom. Two center drawers are mounted between the two pedestals. Two 3" diameter grommets are located in the work surface.
Note: Available in 32-3/16" H only.

Double-Wide Work Desk	Single Pedestal	CH2-238-S00 OAK	CH2-238-S00 MAP	Standing Height Double-Wide Single Pedestal Work Desk	39-3/16" x 70" x 30"	230	\$6,390	\$6,966
--------------------------	-----------------	-----------------	-----------------	--	----------------------	-----	---------	---------

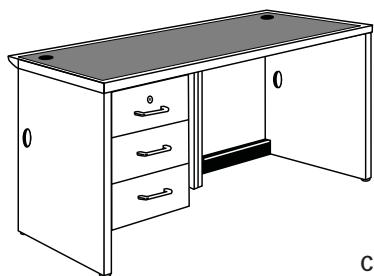

Inside dimensions are 68"W x 26-3/4"D.
 This unit has one drawer pedestal mounted on the left side consisting of one locking drawer at top; two file drawers with Pendaflex hangers at the bottom. Two 3" diameter grommets are located in the work surface.

		CH2-E38-S00 OAK	CH2-E38-S00 MAP	Sitting Height Double-Wide Single Pedestal Work Desk	32-3/16" x 70" x 30"	195	\$6,050	\$6,595
--	--	-----------------	-----------------	---	----------------------	-----	---------	---------

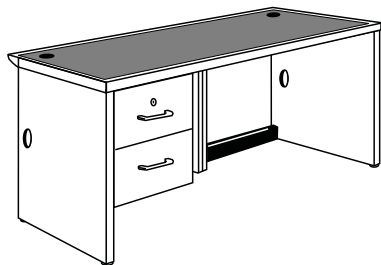

Inside dimensions are 68"W x 26-3/4"D.
 This unit has one drawer pedestal mounted on the left side consisting of one locking file drawer at top; one file drawer at the bottom, both with hanging file racks. Two 3" diameter grommets are located in the work surface.

Please specify Wood Finish (Table 1) and High-Pressure Laminate (Table 2). Details can be found on page GEN 4.

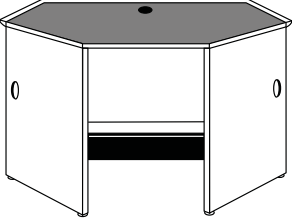
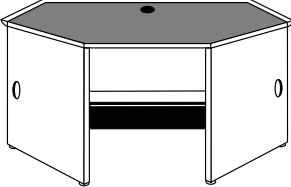
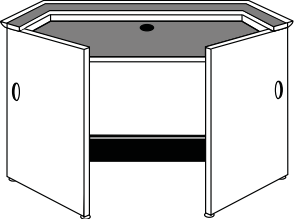
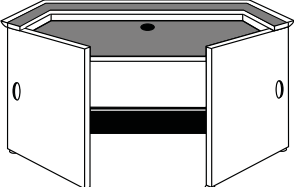
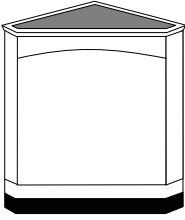
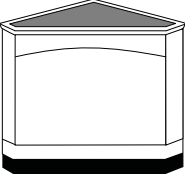
Oak Catalog No.	Maple Catalog No.	Description	H x W x D	Wt. (lbs.)	Oak Price	Maple Price	Standing	Sitting
CH2-010-S00 OAK	CH2-010-S00 MAP	Standing Height 90 Degree Multi-Purpose Corner Unit has 29-5/16" W port area. Storage shelves are located in the two angled areas to the left and right of the desk module. One 3" diameter grommet is located in the work-surface top. One 3-1/2" diameter egress with sleeve is located in each end panel for wire passage.	39-3/16" x 71-3/4" x 30"	250	\$7,812	\$8,514		90 Degree Multi-Purpose Corner
								
CH2-E10-S00 OAK	CH2-E10-S00 MAP	Sitting Height 90 Degree Multi-Purpose Corner Unit has 29-5/16" W port area. Storage shelves are located in the two angled areas to the left and right of the desk module. One 3" diameter grommet is located in the work-surface top. One 3-1/2" diameter egress with sleeve is located in each end panel for wire passage.	32-3/16" x 71-3/4" x 30"	215	\$7,415	\$8,083		
								
CH2-017-S00 OAK	CH2-017-S00 MAP	Standing Height 90 Degree Multi-Purpose with Patron Service Ledge Unit has 29-5/16" W port area. The 7-7/8" D patron ledge is at a height of 39-3/16". Work surface is at 35" H. Storage shelves are located in the two angled areas to the left and right of the module. One 3" diameter grommet is located in the work surface top. One 3-1/2" diameter egress with sleeve is located in each end panel for wire passage.	39-3/16" x 71-3/4" x 30"	245	\$10,196	\$11,113		90 Degree Multi-Purpose Corner with Patron Service Ledge
								
CH2-E17-S00 OAK	CH2-E17-S00 MAP	Sitting Height 90 Degree Multi-Purpose with Patron Service Ledge Unit has 29-5/16" W port area. The 7-7/8" D patron ledge is at a height of 32-3/16". Work surface is at 28" H. Storage shelves are located in the two angled areas to the left and right of the module. One 3" diameter grommet is located in the work surface top. One 3-1/2" diameter egress with sleeve is located in each end panel for wire passage.	32-3/16" x 71-3/4" x 30"	210	\$9,684	\$10,556		
								
CH2-016-S00 OAK	CH2-016-S00 MAP	Standing Height 90 Degree Closed Corner Unit This 90 degree unit is used to form a right angle turn in a desk arrangement. This is not available with patron ledge. One 3-1/2" diameter egress is located in each end panel for wire passage through a continuous ABS tube.	39-3/16" H	140	\$3,556	\$3,875		90 Degree Closed Corner Unit
								
CH2-E16-S00 OAK	CH2-E16-S00 MAP	Sitting Height 90 Degree Closed Corner Unit This 90 degree unit is used to form a right angle turn in a desk arrangement. This is not available with patron ledge. One 3-1/2" diameter egress is located in each end panel for wire passage through a continuous ABS tube.	32-3/16" H	120	\$3,432	\$3,741		
								

Please specify Wood Finish (Table 1) and High-Pressure Laminate (Table 2). Details can be found on page GEN 4.

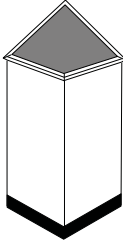
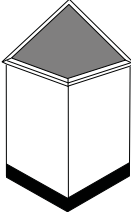
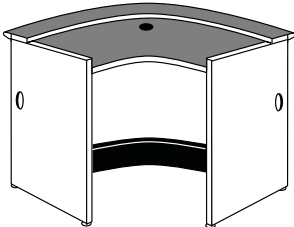
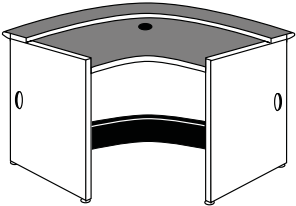
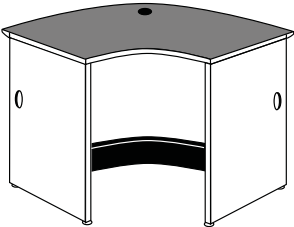
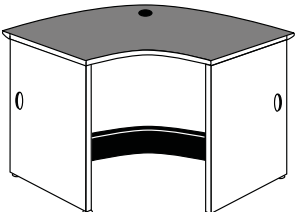
Standing	Sitting	Oak Catalog No.	Maple Catalog No.	Description	H x W x D	Wt. (lbs.)	Oak Price	Maple Price
		CH2-018-S00 OAK	CH2-018-S00 MAP	Standing Height 45 Degree Closed Corner Unit	39-3/16" x 22-7/8" x 30"	130	\$3,556	\$3,875
				This corner unit is used to create a 45 degree angle in the circulation desk. This unit is not available with a patron ledge.				
		CH2-E18-S00 OAK	CH2-E18-S00 MAP	Sitting Height 45 Degree Closed Corner Unit	32-3/16" x 22-7/8" x 30"	110	\$3,432	\$3,741
				This corner unit is used to create a 45 degree angle in the circulation desk. This unit is not available with a patron ledge.				
		CH2-040-S00 OAK	CH2-040-S00 MAP	Standing Height 90 Degree Open Curved Corner with Patron Service Ledge	39-3/16" x 70-1/8" x 30"	245	\$12,610	\$13,744
				The 7-7/8" D patron ledge is at a height of 39-3/16". The work surface is at 35"H. Unit has 26-5/8"W port area. Storage shelves are located in the two angled areas to the left and right of the desk module. One 3" diameter grommet is located in the work surface top. One 3-12" diameter egress with sleeve is located in each end panel for wire passage.				
		CH2-E40-S00 OAK	CH2-E40-S00 MAP	Sitting Height 90 Degree Open Curved Corner with Patron Service Ledge	32-3/16" x 70-1/8" x 30"	210	\$11,888	\$12,958
				The 7-7/8" D patron ledge is at a height of 32-3/16". The work surface is at 35"H. Unit has 26-5/8"W port area. Storage shelves are located in the two angled areas to the left and right of the desk module. One 3" diameter grommet is located in the work surface top. One 3-12" diameter egress with sleeve is located in each end panel for wire passage.				
		CH2-041-S00 OAK	CH2-041-S00 MAP	Standing Height 90 Degree Open Curved Corner	39-3/16" x 70-1/8" x 30"	245	\$11,165	\$12,170
				Work surface is at 39-3/16"H. Unit has 26-5/8"W port area. Storage shelves are located in the two angled areas to the left and right of the desk module. One 3" diameter grommet is located in the work-surface top. One 3-1/2" diameter egress with sleeve is located in each end panel for wire passage.				
		CH2-E41-S00 OAK	CH2-E41-S00 MAP	Sitting Height 90 Degree Open Curved Corner	32-3/16" x 70-1/8" x 30"	210	\$10,522	\$11,469
				Work surface is at 32-3/16"H. Unit has 26-5/8"W port area. Storage shelves are located in the two angled areas to the left and right of the desk module. One 3" diameter grommet is located in the work-surface top. One 3-1/2" diameter egress with sleeve is located in each end panel for wire passage.				

Please specify Wood Finish (Table 1) and High-Pressure Laminate (Table 2). Details can be found on page GEN 4.

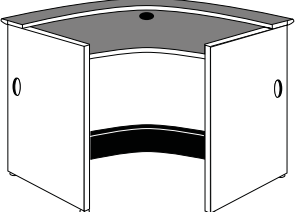
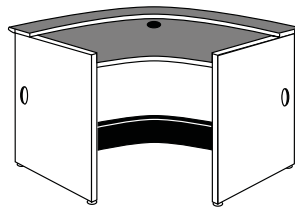
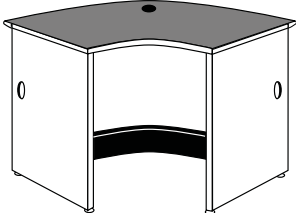
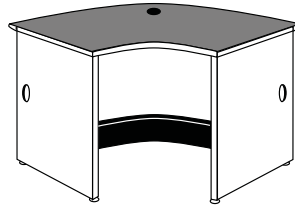
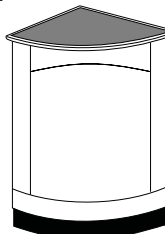
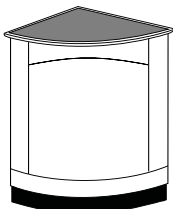
Oak Catalog No.	Maple Catalog No.	Description	H x W x D	Wt. (lbs.)	Oak Price	Maple Price	Standing	Sitting
CH2-047-S00 OAK	CH2-047-S00 MAP	Standing Height 60 Degree Curved Corner with Patron Service Ledge The 7-7/8"D patron ledge is at a height of 39-3/16". The work surface is at 35-7/16"H. Unit has 49-1/16" W port area. Storage shelves are located in the two angled areas to the left and right of the desk module. One 3" diameter grommet is located in the work surface top. One 3-1/2" diameter egress with sleeve is located in each end panel for wire passage.	39-3/16" x 80-3/4" x 30"	245	\$14,675	\$15,996	60 Degree Curved Corner with Patron Service Ledge	
								
CH2-E47-S00 OAK	CH2-E47-S00 MAP	Sitting Height 60 Degree Curved Corner with Patron Service Ledge The 7-7/8"D patron ledge is at a height of 32-3/16". The work surface is at 28"H. Unit has 49-1/16" W port area. Storage shelves are located in the two angled areas to the left and right of the desk module. One 3" diameter grommet is located in the work surface top. One 3-1/2" diameter egress with sleeve is located in each end panel for wire passage.	32-3/16" x 80-3/4" x 30"	210	\$13,899	\$15,150		
								
CH2-048-S00 OAK	CH2-048-S00 MAP	Standing Height 60 Degree Curved Corner Work surface is at 39-3/16"H. Unit has 49-1/16"W port area. Storage shelves are located in the two angled areas to the left and right of the desk module. One 3" diameter grommet is located in the work surface top. One 3-1/2" diameter egress with sleeve is located in each end panel for wire passage.	39-3/16" x 80-3/4" x 30"	245	\$13,238	\$14,430	60 Degree Curved Corner	
								
CH2-E48-S00 OAK	CH2-E48-S00 MAP	Sitting Height 60 Degree Curved Corner Work surface is at 32-3/16"H. Unit has 49-1/16"W port area. Storage shelves are located in the two angled areas to the left and right of the desk module. One 3" diameter grommet is located in the work surface top. One 3-1/2" diameter egress with sleeve is located in each end panel for wire passage.	32-3/16" x 80-3/4" x 30"	210	\$12,557	\$13,687		
								
CH2-055-S00 OAK	CH2-055-S00 MAP	Standing Height 90 Degree Closed Corner Unit This 90 degree unit is used to form a right-angle turn in a desk arrangement. This unit is provided with a curved front panel.	39-3/16"H x 30"D	140	\$5,708	\$6,221	90 Degree Curved Closed Corner Unit	
								
CH2-E55-S00 OAK	CH2-E55-S00 MAP	Sitting Height 90 Degree Closed Corner Unit This 90 degree unit is used to form a right-angle turn in a desk arrangement. This unit is provided with a curved front panel.	32-3/16"H x 30"D	120	\$5,311	\$5,789		
								

Please specify Wood Finish (Table 1) and High-Pressure Laminate (Table 2). Details can be found on page GEN 4.

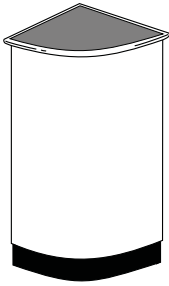
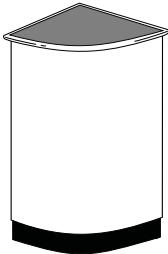
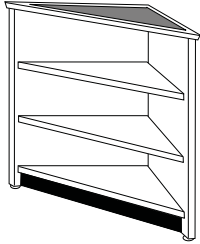
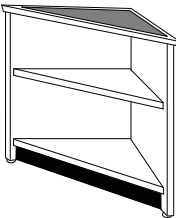
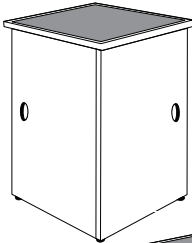
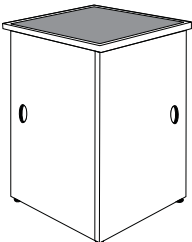
Standing	Sitting	Oak Catalog No.	Maple Catalog No.	Description	H x W x D	Wt. (lbs.)	Oak Price	Maple Price
45 Degree Curved Closed Corner Unit		CH2-058-S00 OAK	CH2-058-S00 MAP	Standing Height 45 Degree Curved Closed Corner Unit This unit is used to create a 45 degree angle in the circulation desk. It is not available with patron ledge.	39-3/16" x 22-3/8" x 30"	130	\$5,708	\$6,221
		CH2-E58-S00 OAK	CH2-E58-S00 MAP	Sitting Height 45 Degree Curved Closed Corner Unit This unit is used to create a 45 degree angle in the circulation desk. It is not available with patron ledge.	32-3/16" x 22-3/8" x 30"	110	\$5,311	\$5,789
90 Degree Open Corner Shelf		CH2-143-S00 OAK	CH2-143-S00 MAP	Standing Height 90 Degree Open Corner Shelf This 90 degree unit is used to form a right-angle turn in a desk arrangement. Has one fixed base shelf and two adjustable shelves. Note: Units must be modified on a project by project basis for electrical pass-through on open corner units.	39-3/16"H x 30"D	140	\$3,571	\$3,893
		CH2-E43-S00 OAK	CH2-E43-S00 MAP	Sitting Height 90 Degree Open Corner Shelf This 90 degree unit is used to form a right-angle turn in a desk arrangement. Has one fixed base shelf and two adjustable shelves. Note: Units must be modified on a project by project basis for electrical pass-through on open corner units.	32-3/16"H x 30"D	120	\$3,417	\$3,725
90 Degree Square Corner Unit		CH2-150-S00 OAK	CH2-150-S00 MAP	Standing Height 90 Degree Square Corner Unit This square corner unit is used to form a right angle in a desk arrangement. One 3" diameter egress is located in each end panel for wire passage through a continuous ABS tube.	39-3/16" x 30" x 30"	160	\$4,139	\$4,511
		CH2-E50-S00 OAK	CH2-E50-S00 MAP	Sitting Height 90 Degree Square Corner Unit This square corner unit is used to form a right angle in a desk arrangement. One 3" diameter egress is located in each end panel for wire passage through a continuous ABS tube.	32-3/16" x 30" x 30"	140	\$3,937	\$4,291

Please specify Wood Finish (Table 1) and High-Pressure Laminate (Table 2). Details can be found on page GEN 4.

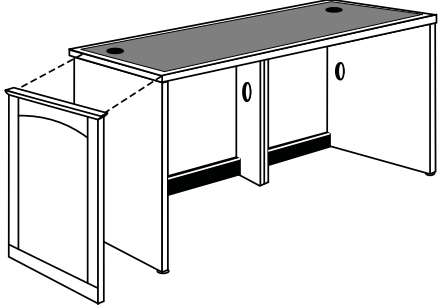
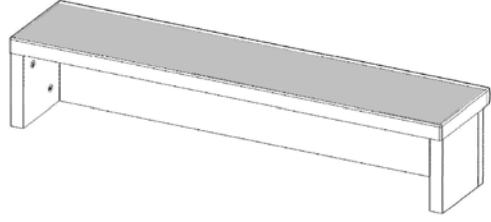
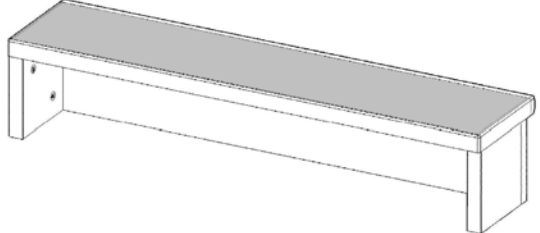
Oak Catalog No.	Maple Catalog No.	Description	H x W x D	Wt. (lbs.)	Oak Price	Maple Price	
CH2-178-S00 OAK	CH2-178-S00 MAP	Detachable End Panels (Pair) End panels are 1" thick, 3-ply, 45# density particleboard core with plain-sliced oak or maple veneers. Exposed edges are externally banded with 1.6mm thick, solid Northern-grown Oak or maple edge band.	39" x 1" x 26-3/4"	52	\$2,150	\$2,344	Detachable End Panels (Pair) 
CH2-E78-S00 OAK	CH2-E78-S00 MAP	Detachable End Panels (Pair) End panels are 1" thick, 3-ply, 45# density particleboard core with plain-sliced oak or maple veneers. Exposed edges are externally banded with 1.6mm thick, solid Northern-grown Oak or maple edge band.	32" x 1" x 26-3/4"	42	\$1,902	\$2,073	
CH2-196-S00 OAK	CH2-196-S00 MAP	Single-Wide Add On 7"H Patron Ledge Unit is designed to be added onto a single wide desk without a patron ledge. The Patron Ledge Assembly will attach to the desktop by means of #8 x 2-1/2" screws inserted through the work surface into the ledge assembly.	7" x 35" x 7-7/8"	10	\$612	\$667	Single-Wide Add On 7"H Patron Ledge 
CH2-197-S00 OAK	CH2-197-S00 MAP	Double-Wide Add On 7"H Patron Ledge Unit is designed to be added onto a double wide desk without a patron ledge. The Patron Ledge Assembly will attach to the desktop by means of #8 x 2-1/2" screws inserted through the work surface into the ledge assembly.	7" x 70" x 7-7/8"	20	\$815	\$888	Double-Wide Add On 7"H Patron Ledge 

Please specify Wood Finish (Table 1) and High-Pressure Laminate (Table 2). Details can be found on page GEN 4.

General Specifications

TABLETOPS

Tabletops are 1-3/16" thick, 3-ply 45# density particleboard core with a .050" high-pressure laminate face and a .020" thick backing sheet on the underside. High-pressure laminate has a low-glare finish resistant to scratches, fading and staining in accordance with NEMA standards. Tabletops are banded on exposed edges with a 1-3/4" thick x 2"W solid-oak external undercut chamfered edge band applied to the table core after lamination of the face plastic. The edge band is beveled at a 39° angle with a 3/8" radius bullnose at the leading edge. Square and rectangular tabletop edge bands are mitered at all four corners with corners radiused 1/8".

TABLE LEGS – SQUARE WITH APRON

Legs are 2-1/2"W square and glued-up face to face from three solid-oak blanks. All glue joints are tight and smooth. All vertical edges receive a 1/4" radius. Legs receive a horizontal vein line 5/32"W x 3/32"D on the two outside faces of the leg positioned 3-11/32" below the top of the legs. This vein line matches the horizontal vein line on the apron. An identical vein line is positioned 3-1/4" above the bottom of the leg. At the bottom of this vein line the two back sides of the leg taper to a dimension of 1-7/8" x 1-7/8" at the bottom of the leg. Legs receive a 1-1/2" diameter adjustable glide mounted in a recessed tee-nut. The glide is further recessed into the leg by means of a countersunk boring which accepts the upper two-thirds of the glide. Tables are of apron design with a 3-1/2" x 1" thick apron screwed to the underside of the tabletop. A 5/32"W x 3/32"D vein line is positioned at the bottom front surface of the apron to mirror the top horizontal vein line on the table leg. The legs attach to the aprons by means of formed 14-gauge steel corner brackets. Each leg is bolted to the corner bracket with two 5/16" - 18 hex-head bolts which pass through the bracket and engage threaded bushings embedded into the leg and cross-pinned with a 3/16" diameter steel pin.

TABLE LEGS – SQUARE WITHOUT APRON

Legs are 2-1/2"W, square shape, and glued-up face to face from three solid-oak blanks. All glue joints are tight and smooth. All vertical edges receive a 1/4" radius. Legs receive a horizontal vein line 5/32"W x 3/32"D on the two outside faces of the leg positioned 3-11/32" below the top of the legs. An identical vein line is positioned 3-1/4" above the bottom of the leg. At the bottom of this vein line the two back sides of the leg taper to a dimension of 1-7/8" x 1-7/8" at the bottom of the leg. Table is designed without an apron, with legs attaching to the tabletop by means of a 5" square x 5/16" thick steel plate. Plates are painted flat black and have no sharp edges. The plate is attached to the leg by a 5/16" x 2-1/2" machine bolt engaging a 5/8" diameter barrel nut inserted in the leg. The steel plate is attached to the tabletop by five 5/16" x 1" machine bolts engaging internally and externally threaded bushings embedded in the underside of the tabletop. Leg plates are positioned behind, and hidden by the extended edge band. Edge bands extend 1/2" below the tabletop. Each leg has a 1-1/2" diameter adjustable glide mounted in a recessed tee-nut. The glide is further recessed into the leg by means of a countersunk boring which accepts the upper two-thirds of the glide.

TABLE LEGS – ROUND WITH APRON

Legs are solid, glued-up oak, face-to-face glued from three to four oak blanks. All glue joints are tight and smooth. Table is of apron design with a 3-1/2"W x 1" thick apron screwed to the underside of the tabletop. A 1/4"D "V" groove is positioned 1/2" from the bottom edge of the apron. The bottom edge is radiused 1/4" to mirror the decorative raised rings on the cylindrical portion of the leg. The top of the leg is 2-7/8" square, radiused 1/4" on the vertical edges. The leg then transitions to a 2-1/2" diameter. A 5/8"W x 2-3/4" diameter ring is positioned 3/16" below squared portion of the leg and is radiused 3/8" to accent the transition from square to round. A second ring is positioned 2" from the bottom of the leg. Each leg has a 2" diameter adjustable glide mounted in a recessed tee-nut. The glide is further recessed into the leg by means of a countersunk boring which accepts the upper two-thirds of the glide. The legs attach to the aprons by means of formed 14-gauge steel corner brackets. Each leg is bolted to the corner bracket with two 5/16" - 18 hex head bolts which pass through the bracket and engage threaded bushings, embedded into the leg and cross-pinned with a 3/16" diameter steel pin.

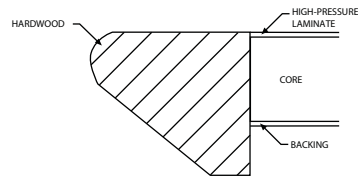

Chancellor's Series Drop Edge

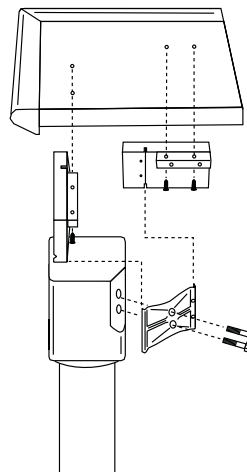

Chancellor's Series Leg With Apron

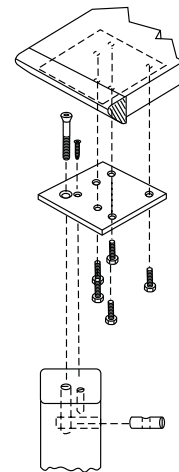

Chancellor's Series Leg Without Apron

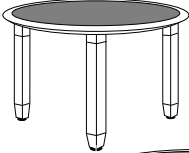
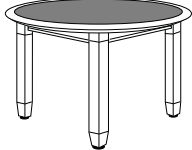
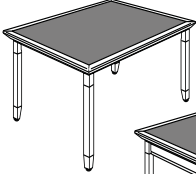
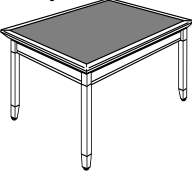
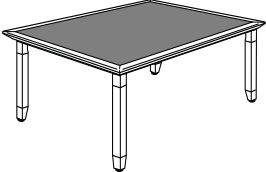
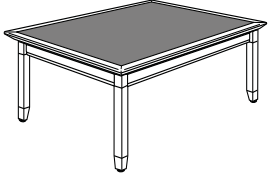
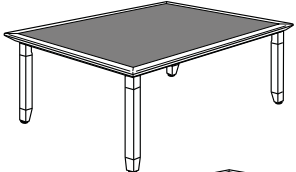
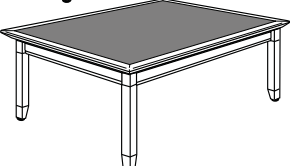
Oak Catalog No.	Maple Catalog No.	Description	H x W x D	Wt. (lbs.)	Oak Price	Maple Price	Without Apron	With Apron
<i>Table with Chamfered Square Legs without Apron</i>							Round Table	
CH2-109-S00 OAK	CH2-109-S00 MAP	Round Table	29"H x 38" Diameter	100	\$2,329	\$2,539		
CH2-129-S00 OAK	CH2-129-S00 MAP	Round Table	29"H x 44" Diameter	90	\$2,476	\$2,699		
CH2-141-S00 OAK	CH2-141-S00 MAP	Round Table	29"H x 50" Diameter	100	\$2,476	\$2,699		
CH2-130-S00 OAK	CH2-130-S00 MAP	Round Table	29"H x 62" Diameter	110	\$3,156	\$3,440		
<i>Table with Chamfered Square Legs with Apron</i>								
CH2-A09-S00 OAK	CH2-A09-S00 MAP	Round Table	29"H x 38" Diameter	100	\$2,444	\$2,664		
CH2-A29-S00 OAK	CH2-A29-S00 MAP	Round Table	29"H x 44" Diameter	90	\$2,593	\$2,826		
CH2-A41-S00 OAK	CH2-A41-S00 MAP	Round Table	29"H x 50" Diameter	100	\$2,593	\$2,826		
CH2-A30-S00 OAK	CH2-A30-S00 MAP	Round Table	29"H x 62" Diameter	110	\$3,317	\$3,616		
<i>Table with Chamfered Square Legs without Apron</i>							Square Table	
CH2-191-S00 OAK	CH2-191-S00 MAP	Square Table	29" x 32-3/4" x 32-3/4"	100	\$2,019	\$2,201		
CH2-137-S00 OAK	CH2-137-S00 MAP	Square Table	29" x 44-3/4" x 44-3/4"	100	\$2,166	\$2,361		
CH2-154-S00 OAK	CH2-154-S00 MAP	Square Table	29" x 50-3/4" x 50-3/4"	100	\$2,314	\$2,523		
<i>Table with Chamfered Square Legs with Apron</i>								
CH2-A91-S00 OAK	CH2-A91-S00 MAP	Square Table	29" x 32-3/4" x 32-3/4"	100	\$2,128	\$2,320		
CH2-A37-S00 OAK	CH2-A37-S00 MAP	Square Table	29" x 44-3/4" x 44-3/4"	100	\$2,275	\$2,480		
CH2-A54-S00 OAK	CH2-A54-S00 MAP	Square Table	29" x 50-3/4" x 50-3/4"	100	\$2,423	\$2,641		
<i>Table with Chamfered Square Legs without Apron</i>							Rectangular Table	
CH2-194-S00 OAK	CH2-194-S00 MAP	Rectangular Table	29" x 62-3/4" x 32-3/4"	110	\$2,205	\$2,404		
CH2-195-S00 OAK	CH2-195-S00 MAP	Rectangular Table	29" x 74-3/4" x 32-3/4"	130	\$2,314	\$2,523		
CH2-144-S00 OAK	CH2-144-S00 MAP	Rectangular Table	29" x 62-3/4" x 38-3/4"	110	\$2,251	\$2,453		
CH2-138-S00 OAK	CH2-138-S00 MAP	Rectangular Table	29" x 74-3/4" x 38-3/4"	130	\$2,360	\$2,572		
CH2-145-S00 OAK	CH2-145-S00 MAP	Rectangular Table	29" x 74-3/4" x 50-3/4"	160	\$2,671	\$2,911		
<i>Table with Chamfered Square Legs with Apron</i>								
CH2-A94-S00 OAK	CH2-A94-S00 MAP	Rectangular Table	29" x 62-3/4" x 32-3/4"	110	\$2,314	\$2,523		
CH2-A95-S00 OAK	CH2-A95-S00 MAP	Rectangular Table	29" x 74-3/4" x 32-3/4"	130	\$2,423	\$2,641		
CH2-A44-S00 OAK	CH2-A44-S00 MAP	Rectangular Table	29" x 62-3/4" x 38-3/4"	110	\$2,360	\$2,572		
CH2-A38-S00 OAK	CH2-A38-S00 MAP	Rectangular Table	29" x 74-3/4" x 38-3/4"	130	\$2,476	\$2,699		
CH2-A45-S00 OAK	CH2-A45-S00 MAP	Rectangular Table	29" x 74-3/4" x 50-3/4"	160	\$2,811	\$3,064		
<i>Table with Chamfered Square Legs without Apron</i>							Rectangular Table with Center Support Legs	
CH2-198-S00 OAK	CH2-198-S00 MAP	Rectangular Table	29" x 92-3/4" x 32-3/4"	150	\$2,785	\$3,036		
CH2-146-S00 OAK	CH2-146-S00 MAP	Rectangular Table	29" x 92-3/4" x 38-3/4"	150	\$2,834	\$3,089		
CH2-134-S00 OAK	CH2-134-S00 MAP	Rectangular Table	29" x 92-3/4" x 50-3/4"	200	\$3,254	\$3,547		
<i>Table with Chamfered Square Legs with Apron</i>								
CH2-A98-S00 OAK	CH2-A98-S00 MAP	Rectangular Table	29" x 92-3/4" x 32-3/4"	150	\$2,894	\$3,155		
CH2-A46-S00 OAK	CH2-A46-S00 MAP	Rectangular Table	29" x 92-3/4" x 38-3/4"	150	\$2,982	\$3,250		
CH2-A34-S00 OAK	CH2-A34-S00 MAP	Rectangular Table	29" x 92-3/4" x 50-3/4"	200	\$3,432	\$3,741		

Please specify Wood Finish (Table 1) and High-Pressure Laminate (Table 2). Details can be found on page GEN 4.

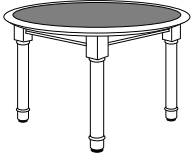
	Oak Catalog No.	Maple Catalog No.	Description	H x W x D	Wt. (lbs.)	Oak Price	Maple Price
	<i>Table with Traditional Round Legs with Apron</i>						
	CH2-R09-S00 OAK	CH2-R09-S00 MAP	Round Table	29"H x 38" Diameter	100	\$2,444	\$2,664
	CH2-R29-S00 OAK	CH2-R29-S00 MAP	Round Table	29"H x 44" Diameter	90	\$2,593	\$2,826
	CH2-R41-S00 OAK	CH2-R41-S00 MAP	Round Table	29"H x 50" Diameter	100	\$2,593	\$2,826
	CH2-R30-S00 OAK	CH2-R30-S00 MAP	Round Table	29"H x 62" Diameter	110	\$3,317	\$3,616

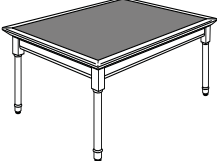
	Oak Catalog No.	Maple Catalog No.	Description	H x W x D	Wt. (lbs.)	Oak Price	Maple Price
	<i>Table with Traditional Round Legs with Apron</i>						
	CH2-R91-S00 OAK	CH2-R91-S00 MAP	Square Table	29" x 32-3/4" x 32-3/4"	100	\$2,128	\$2,320
	CH2-R37-S00 OAK	CH2-R37-S00 MAP	Square Table	29" x 44-3/4" x 44-3/4"	100	\$2,275	\$2,480
	CH2-R54-S00 OAK	CH2-R54-S00 MAP	Square Table	29" x 50-3/4" x 50-3/4"	100	\$2,423	\$2,641

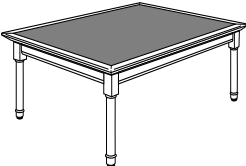
	Oak Catalog No.	Maple Catalog No.	Description	H x W x D	Wt. (lbs.)	Oak Price	Maple Price
	<i>Table with Traditional Round Legs with Apron</i>						
	CH2-R94-S00 OAK	CH2-R94-S00 MAP	Rectangular Table	29" x 62-3/4" x 32-3/4"	110	\$2,314	\$2,523
	CH2-R95-S00 OAK	CH2-R95-S00 MAP	Rectangular Table	29" x 74-3/4" x 32-3/4"	130	\$2,423	\$2,641
	CH2-R44-S00 OAK	CH2-R44-S00 MAP	Rectangular Table	29" x 62-3/4" x 38-3/4"	110	\$2,360	\$2,572
	CH2-R38-S00 OAK	CH2-R38-S00 MAP	Rectangular Table	29" x 74-3/4" x 38-3/4"	130	\$2,476	\$2,699
	CH2-R45-S00 OAK	CH2-R45-S00 MAP	Rectangular Table	29" x 74-3/4" x 50-3/4"	160	\$2,811	\$3,064

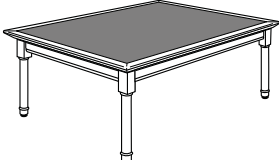
	Oak Catalog No.	Maple Catalog No.	Description	H x W x D	Wt. (lbs.)	Oak Price	Maple Price
	<i>Table with Traditional Round Legs with Apron</i>						
	CH2-R98-S00 OAK	CH2-R98-S00 MAP	Rectangular Table	29" x 92-3/4" x 32-3/4"	150	\$2,894	\$3,155
	CH2-R46-S00 OAK	CH2-R46-S00 MAP	Rectangular Table	29" x 92-3/4" x 38-3/4"	150	\$2,982	\$3,250
	CH2-R34-S00 OAK	CH2-R34-S00 MAP	Rectangular Table	29" x 92-3/4" x 50-3/4"	200	\$3,432	\$3,741

Please specify Wood Finish (Table 1) and High-Pressure Laminate (Table 2). Details can be found on page GEN 4.

General Specifications

TABLETOPS

Tabletops are 1-3/16" thick, 3-ply 45# density particleboard core with a .050" high-pressure laminate face and a .020" thick backing sheet on the underside. High-pressure laminate has a low-glare finish resistant to scratches, fading and staining in accordance with NEMA standards. Tabletops are banded on exposed edges with a 1-3/4" thick x 2"W solid-oak external undercut chamfered edge band applied to the table core after lamination of the face plastic. The edge band is beveled at a 39° angle with a 3/8" radius bullnose at the leading edge. The edge band extends 1-3/4" beyond the vertical ends of the panel base and is notched at each end at a 45° angle.

TABLE END PANELS

Table end panels are 1-3/16" thick, 3-ply 45# density particleboard core with select plain-sliced, slip-matched oak veneer on the inside face. Veneer on outside face is sketched to form a "framed" appearance. The frame is composed of 3-1/4" rift-cut, oak-veneer strips along both vertical edges and a 3-1/4" solid wood plinth at the bottom edge. At the top edge is a 3-1/4" rift cut oak veneer strip shaped to form a 1-1/2"H

internal arc. Within the frame is select plain-sliced, slip-matched ash veneer. Panels are externally banded with 1.6mm thick solid oak on the two vertical and top edges. All panel edges are eased. Each panel has two 1-1/4" diameter chrome, adjustable glides. End panels extend 1/4" above tabletop work surface.

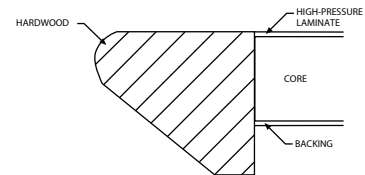

Chancellor's Series Drop Edge

Oak Catalog No.	Maple Catalog No.	Description	H x W x D	Wt. (lbs.)	Oak Price	Maple Price
CH2-P44-S00 OAK	CH2-P44-S00 MAP	Panel Base Table	29" x 62-3/4" x 38-3/4"	130	\$2,866	\$3,124
CH2-P38-S00 OAK	CH2-P38-S00 MAP	Panel Base Table	29" x 74-3/4" x 38-3/4"	150	\$3,137	\$3,419
CH2-P46-S00 OAK	CH2-P46-S00 MAP	Panel Base Table	29" x 92-3/4" x 38-3/4"	170	\$3,246	\$3,538
CH2-P45-S00 OAK	CH2-P45-S00 MAP	Panel Base Table	29" x 74-3/4" x 50-3/4"	180	\$3,455	\$3,766
CH2-P34-S00 OAK	CH2-P34-S00 MAP	Panel Base Table	29" x 92-3/4" x 50-3/4"	200	\$4,046	\$4,410

Table with Panel Base

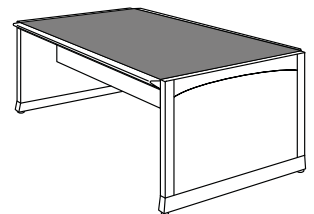

Please specify Wood Finish (Table 1) and High-Pressure Laminate (Table 2). Details can be found on page GEN 4.

General Specifications

TABLETOP

Standard tabletops are 1-3/16" thick, 3-ply particleboard core including a top surface of .050" thick high-pressure laminate, and a backing sheet .020" thick for balanced construction. High-pressure laminate has a low-glare finish resistant to scratches, fading, and staining in accordance with NEMA standards. Tabletops are banded on exposed edges with a 1-3/4" thick x 2"W solid-oak external undercut chamfered edge band applied to the table core after lamination of the face plastic. The edge band is beveled at a 39° angle with 3/8" radius bullnose at the leading edge. Square and rectangular tabletop edge bands are mitered at all four corners with corners radiused 1/8". Note: All Standing-Height Tables are made with an apron. All Sitting-Height Tables are made without an apron to allow adequate leg clearance.

TABLE LEGS – SQUARE WITH APRON

Legs are 2-1/2"W, square shape, glued-up face to face from three solid-oak blanks. All glue joints are tight and smooth. All vertical edges receive a 1/4" radius. Legs receive a horizontal vein line 5/32"W x 3/32"D on the two outside faces of the leg positioned 3-11/32" below the top of the legs. This vein line matches the horizontal vein line on the apron. An identical vein line is positioned 3-1/4" above the bottom of the leg. At the bottom of this vein line the two back sides of the leg taper to a dimension of 1-7/8" x 1-7/8" at the bottom of the leg. Legs receive a 1-1/2" diameter adjustable glide mounted in a recessed tee-nut. The glide is further recessed into the leg by means of a countersunk boring which accepts the upper two-thirds of the glide. Tables are of apron design with a 3-1/2" x 1" thick apron screwed to the underside of the tabletop. A 5/32"W x 3/32"D vein line is positioned at the bottom front surface of the apron to mirror the top horizontal vein line on the table leg. The legs attach to the aprons by means of formed 14-gauge steel corner brackets. Each leg is bolted to the corner bracket with two 5/16" - 18 hex-head bolts which pass through the bracket and engage threaded bushings embedded into the leg and cross-pinned with a 3/16" diameter steel pin.

TABLE LEGS – SQUARE WITHOUT APRON

Legs are 2-1/2"W, square shape, glued-up face to face from three solid-oak blanks. All glue joints are tight and smooth. All vertical edges receive a 1/4" radius. Legs receive a horizontal vein line 5/32"W x 3/32"D on the two outside faces of the leg positioned 3-11/32" below the top of the legs. An identical vein line is positioned 3-1/4" above the bottom of the leg. At the bottom of this vein line the two back sides of the leg taper to a dimension of 1-7/8" x 1-7/8" at the bottom of the leg. Tables are without an apron, with legs attaching to the tabletop by means of a 5" square x 5/16" thick steel plate. Plates are painted flat black and have no sharp edges. The plate is attached to the leg by a 5/16" x 2-1/2" machine bolt engaging a 5/8" diameter barrel nut inserted in the leg. The steel plate is attached to the tabletop by five 5/16" x 1" machine bolts engaging internally and externally threaded bushings embedded in the underside of the tabletop. Leg plates are positioned behind and hidden by the extended edge band. Edge bands extend 1/2" below the tabletop. Each leg has a 1-1/2" diameter adjustable glide mounted in a recessed tee-nut. The glide is further recessed into the leg by means of a countersunk boring which accepts the upper two-thirds of the glide. Additional leg(s) added to the center of the table for extra support are 2-1/4" square with a 1/2" radius on vertical edges.

EQUIPMENT SHIELD PRIVACY PANEL

Privacy panels are 10"H, constructed of 1" thick veneer-core plywood. Exposed panel edges are banded with 1.6mm solid oak. The privacy panel attaches securely to the tabletop by screws passing through the tabletop and into the privacy panels. Privacy panels are finished to match the table edge band. Privacy panels are designed to obscure wires exiting computer equipment and to eliminate incidental tampering.

ELECTRICAL

Tables receive 3" grommets in the tabletop for wire passage, and J-channel wire managers are mounted under the tabletop to hold excess wires. Grommets are ABS, black plastic with notched removable cap. J-channel is 18-gauge steel with electrostatically applied black powder paint.

TABLETOP HEIGHT

Standing Height: 39" (with Apron)
Sitting Height: 27-1/2" (without Apron)

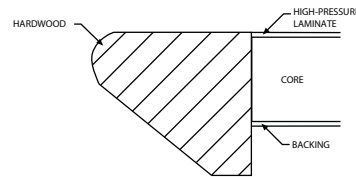

Chancellor's Series Drop Edge

Computer Tables

The Chancellor's Collection

Oak Catalog No.	Maple Catalog No.	Description	H x W x D	Wt. (lbs.)	Oak Price	Maple Price	Standing with Apron	Sitting without Apron
CH2-645-S00 OAK	CH2-645-S00 MAP	Sitting Height	27-1/2" x 32-3/4" x 26-3/4"	80	\$1,784	\$1,945		One Position Computer Tables
CH2-665-S00 OAK	CH2-665-S00 MAP	Sitting Height	27-1/2" x 32-3/4" x 32-3/4"	80	\$2,128	\$2,320		



CH2-649-S00 OAK	CH2-649-S00 MAP	Sitting Height	27-1/2" x 62-3/4" x 26-3/4"	110	\$2,765	\$3,014	Two Position Computer Tables
CH2-669-S00 OAK	CH2-669-S00 MAP	Sitting Height	27-1/2" x 62-3/4" x 32-3/4"	110	\$2,880	\$3,140	

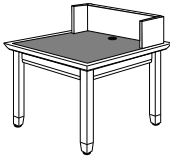
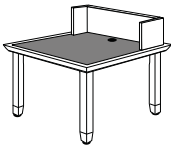

CH2-643-S00 OAK	CH2-643-S00 MAP	Sitting Height	27-1/2" x 38-3/4" x 26-3/4"	70	\$2,174	\$2,369	One Position Computer Table with 10"H Privacy Panel
CH2-663-S00 OAK	CH2-663-S00 MAP	Sitting Height	27-1/2" x 38-3/4" x 38-3/4"	70	\$2,283	\$2,488	

CH2-643-S05 OAK	CH2-643-S05 MAP	Standing Height	39" x 38-3/4" x 26-3/4"	75	\$2,360	\$2,572	 
CH2-663-S05 OAK	CH2-663-S05 MAP	Standing Height	39" x 38-3/4" x 38-3/4"	75	\$2,469	\$2,691	

CH2-642-S00 OAK	CH2-642-S00 MAP	Sitting Height	27-1/2" x 74-3/4" x 26-3/4"	150	\$3,114	\$3,395	Two Position Computer Table with 10"H Privacy Panel
CH2-662-S00 OAK	CH2-662-S00 MAP	Sitting Height	27-1/2" x 74-3/4" x 38-3/4"	150	\$3,269	\$3,563	

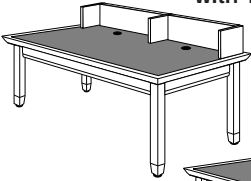
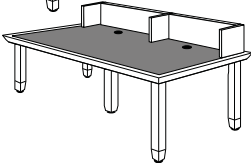
CH2-642-S05 OAK	CH2-642-S05 MAP	Standing Height	39" x 74-3/4" x 26-3/4"	155	\$3,393	\$3,698	 
CH2-662-S05 OAK	CH2-662-S05 MAP	Standing Height	39" x 74-3/4" x 38-3/4"	155	\$3,549	\$3,869	

CH2-644-S00 OAK	CH2-644-S00 MAP	Sitting Height	27-1/2" x 92-3/4" x 26-3/4"	180	\$3,735	\$4,072	Three Position Computer Table with 10"H Privacy Panel
CH2-664-S00 OAK	CH2-664-S00 MAP	Sitting Height	27-1/2" x 92-3/4" x 38-3/4"	180	\$3,967	\$4,324	

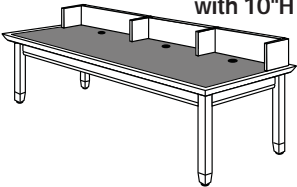
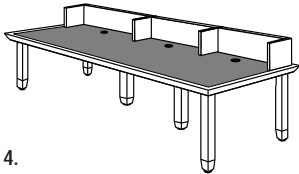
CH2-644-S05 OAK	CH2-644-S05 MAP	Standing Height	39" x 92-3/4" x 26-3/4"	185	\$4,123	\$4,494	 
CH2-664-S05 OAK	CH2-664-S05 MAP	Standing Height	39" x 92-3/4" x 38-3/4"	185	\$4,356	\$4,748	

Please specify Wood Finish (Table 1) and High-Pressure Laminate (Table 2). Details can be found on page GEN 4.

General Specifications

CARRELS

Carrels are designed in a modular starter and adder system. The carrel top is 36"W x 28-1/2"D. A 1-1/2"W cord drop runs the width of the carrel between work surface and back panel to allow passage of electrical cords. The carrel shelf is 36"W x 8"D. End panels and intermediate panels are 48"H and 30"D. The carrel top is attached to end panels and intermediate panels by means of a steel, angled "Z" bracket inserted into a route on the underside of the carrel top and screwed. The opposing leg of the "Z" bracket bolts to end panels or intermediate panels with 5/16"-18 hex-head bolts into metal bushings. The back panel is attached to end and intermediate panels using hidden metal keyways and shoulder screws. The shelf is attached to end and intermediate panels and back panels with 3/4" x 3/4" aluminum or steel angle brackets painted black, with black #8 screws.

CARREL TOP

The carrel top is 1-3/16" thick, 45# density particleboard core including a top surface of .050" thick, high-pressure laminate and a backing sheet not less than .020" thick for balanced construction. High-pressure laminate has a low-glare finish resistant to scratches, fading and staining in accordance with NEMA standards. The exposed edge is banded with a 1-3/4" thick x 2"W solid-oak external undercut chamfered edge band laminated to the work surface core after lamination of the face plastic. The edge band is beveled to a 3/8" radius bullnose at the leading edge. Bevel is at a 39° angle. The edge band extends 1-3/4" beyond the vertical end and intermediate panels and is notched at each end at a 45° angle. The back edge of the top has a black plastic strip 1-1/2"W which projects above the work surface 1/4" to act as a retainer. All work surfaces are adjustable in height to 29" (Sitting) and 32" (Wheelchair).

END AND INTERMEDIATE PANELS

End and intermediate panels are 1-3/16" thick, 3-ply 45# particleboard core. The inside face of end panels and both faces of intermediate panels are select plain-sliced, slip-matched oak veneer. Veneer on the outside face of end panels is sketched to form a "framed" appearance. The "frame" is composed of 3-1/4" rift-cut, oak-veneer strips along both vertical edges and a 3-1/4" solid wood plinth at the bottom edge. At the top edge is a 3-1/4" rift cut oak veneer strip shaped to form a 1-1/2"H internal arc. Within the frame is select plain-sliced, slip-matched ash veneer. On the double-faced end panel a 3"W rift-cut, oak veneer strip is positioned between the top and bottom oak veneer strips and located at the center of the end panel. The vertical edges of the end panel receive a 1.6mm solid oak external edge band. The top edge of the panel receives a 2-1/4"W x 1-1/4"H solid oak top cap. Top cap is 1-3/16"W at the bottom sloping outward on both sides at a 60° angle. Both the front and back edges of the top cap receive a 3/8" radius. Each panel has two 1-1/4" diameter chrome adjustable glides.

BACK PANEL

The back panel is 1-3/16" thick, 3-ply 45# density particleboard core with select plain-sliced, slip-matched oak veneer on both faces. Top edge of the back panel is shaped to form an arc. Panels extend to within 1" of the bottom of end panels. Panels are banded externally with 1.6mm thick solid oak on top and bottom edges. Banded edges are eased.

CARREL SHELF

The carrel shelf is 3/4" thick x 8"D, 45# density particleboard core with select AA slip-matched oak veneer. The shelf has a 1-3/4"W x 3/4" thick solid-oak external band on the exposed edge.

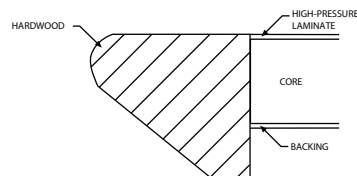

Chancellor's Series Drop Edge

Oak Catalog No.	Maple Catalog No.	Description	H x W x D	Wt. (lbs.)	Oak Price	Maple Price
<u>36" Wide Working Space</u>						
CH2-160-S00 OAK	CH2-160-S00 MAP	S/F Starter	49" x 39-1/2" x 32-1/2"	165	\$3,711	\$4,045
CH2-159-S00 OAK	CH2-159-S00 MAP	S/F Adder	49" x 37-3/4" x 32-1/2"	115	\$2,796	\$3,047

Single-Faced
Modular Study Carrel

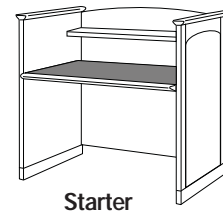

Starter

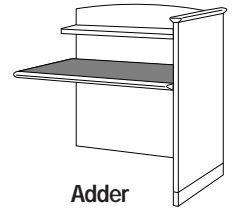

Adder

<u>36" Wide Working Space</u>						
CH2-161-S00 OAK	CH2-161-S00 MAP	D/F Starter	49" x 39-1/2" x 61-1/4"	305	\$5,334	\$5,814
CH2-162-S00 OAK	CH2-162-S00 MAP	D/F Adder	49" x 37-3/4" x 61-1/4"	205	\$3,914	\$4,267

Double-Faced
Modular Study Carrel

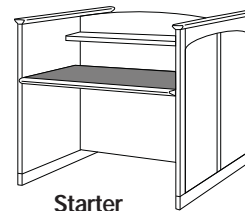

Starter

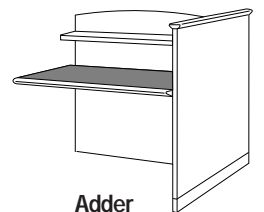

Adder

Please specify Wood Finish (Table 1) and High-Pressure Laminate (Table 2). Details can be found on page GEN 4.

General Specifications

WORKSTATIONS

Workstations are designed in a modular starter and adder system. The workstation tops are 36" or 48"W x 28-1/2"D. A 1-1/2"W cord drop runs the width of the carrel between work surface and back panel to allow passage of electrical cords. The workstation shelf is 36" or 48"W x 8"D. End panels and intermediate panels are 48"H and 30"D. The workstation top is attached to end and intermediate panels by means of a steel, angled "Z" bracket inserted into a route on the underside of the workstation top and screwed. The opposing leg of the "Z" bracket bolts to end panels or intermediate panels with 5/16"-18 hex-head bolts into metal bushings. The back panel is attached to end and intermediate panels using hidden metal keyways and shoulder screws. The shelf is attached to end, intermediate, and back panels with 3/4" x 3/4" aluminum or steel angle brackets painted black with black #8 screws.

WORKSTATION TOP

The workstation top is 1-3/16" thick, 45# density particleboard core including a top surface of .050" thick, high-pressure laminate and a backing sheet not less than .020" thick for balanced construction. High-pressure laminate has a low-glare finish resistant to scratches, fading, and staining in accordance with NEMA standards. The exposed edge is banded with a 1-3/4" thick x 2"W solid-oak external undercut chamfered edge band laminated to the work surface core after lamination of the face plastic. The edge band is beveled to a 3/8" radius bullnose at the leading edge. Bevel is at a 39° angle. The edge band extends 1-3/4" beyond the vertical end and intermediate panels and is notched at each end at a 45° angle. The back edge of the top has a black metal band 1-1/2"W which projects above the work surface 1/4" to act as a retainer. All work surfaces are adjustable in heights to 27" (Sitting), 32" (Wheelchair), and 39" (Standing).

END AND INTERMEDIATE PANELS

End and intermediate panels are 1-3/16" thick, 3-ply 45# particleboard core. The inside face of end panels and both faces of intermediate panels are select plain-sliced, slip-matched oak veneer. Veneer on the outside face of end panels is sketched to form a "framed" appearance. The "frame" is composed of 3-1/4" rift-cut, oak-veneer strips along both vertical edges and a 3-1/4" solid wood plinth at the bottom edge. At the top edge is a 3-1/4" rift-cut oak veneer strip shaped to form a 1-1/2"H internal arc. Within the frame is select plain-sliced, slip-matched ash veneer. On the double-faced end panel a 3"W rift-cut, oak veneer strip is positioned between the top and bottom oak veneer strips and located at the center of the end panel. The vertical edges of the end panels receive a 1.6mm solid oak external edge band. The top edge of the panel receives a 2-1/4"W x 1-1/4"H solid oak top cap. The top cap is 1-3/16"W at the bottom sloping outward on both sides at a 60° angle. Both front and back edges of the top cap receive a 3/8" radius. Each panel has two 1-1/4" diameter chrome adjustable glides.

BACK PANEL

The back panel is 1-3/16" thick, 3-ply 45# density particleboard core with select plain-sliced, slip-matched oak veneer on both faces. Top edge of the back panel is shaped to form an arc. Panels extend to within 1" of the bottom of end panels. Panels are banded externally with 1.6mm thick solid oak on all edges. Banded edges are eased.

WORKSTATION SHELF

The workstation shelf is 3/4" thick x 8"D, 45# density particleboard core with select AA slip-matched oak veneer. The shelf has a 3/4" thick solid oak external band on the exposed edge. The shelf is located under the work surface and extends the full width of the workstation.

WORK SURFACE HEIGHTS

Adjustable at 27", 32" and 39".

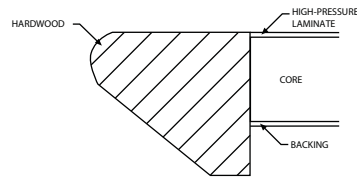

Chancellor's Series Drop Edge

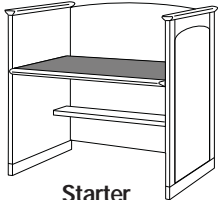
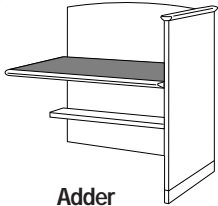
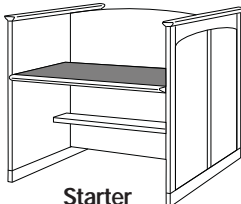
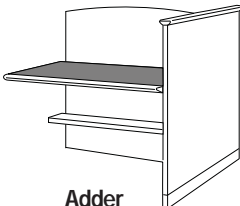
Oak Catalog No.	Maple Catalog No.	Description	H x W x D	Wt. (lbs.)	Oak Price	Maple Price	Starter	Adder
36" Wide Working Space							Single-Faced Information Access Workstations/Carrels	
CH2-673-S00 OAK	CH2-673-S00 MAP	S/F Starter	49" x 39-1/2" x 32-1/2"	165	\$3,711	\$4,045		
CH2-672-S00 OAK	CH2-672-S00 MAP	S/F Adder	49" x 37-3/4" x 32-1/2"	115	\$2,796	\$3,047		
48" Wide Working Space								
CH2-460-S00 OAK	CH2-460-S00 MAP	S/F Starter	49" x 51-1/2" x 32-1/2"	195	\$4,021	\$4,383		
CH2-459-S00 OAK	CH2-459-S00 MAP	S/F Adder	49" x 49-3/4" x 32-1/2"	145	\$3,214	\$3,503		
36" Wide Working Space							Double-Faced Information Access Workstations/Carrels	
CH2-674-S00 OAK	CH2-674-S00 MAP	D/F Starter	49" x 39-1/2" x 61-1/4"	306	\$5,334	\$5,814		
CH2-675-S00 OAK	CH2-675-S00 MAP	D/F Adder	49" x 37-3/4" x 61-1/4"	205	\$3,914	\$4,267		
48" Wide Working Space								
CH2-461-S00 OAK	CH2-461-S00 MAP	D/F Starter	49" x 51-1/2" x 61-1/4"	366	\$6,002	\$6,542		
CH2-462-S00 OAK	CH2-462-S00 MAP	D/F Adder	49" x 49-3/4" x 61-1/4"	265	\$4,597	\$5,011		

Please specify Wood Finish (Table 1) and High-Pressure Laminate (Table 2). Details can be found on page GEN 4.

General Specifications

WORKSTATIONS

Workstations are of modular starter and adder design, with an overall height 33". Workstations are available in 36", 48", 72", 96", and 108" widths. A knee-space panel located below the work surface supports all work surfaces greater than 48"W. Work surface height is at 27-1/2". Work surface depth is 27-1/2" with an additional 1-1/2"W cord drop between the work surface and back panel to allow passage of electrical cords. Work surface is attached to end and intermediate panels by means of two metal 22-1/2" long "Z" brackets with 5/16" – 18 hex-head bolts engaging internally and externally threaded bushings embedded into panels. The back panel is attached to end and intermediate panels using hidden metal keyways and shoulder screws. The shelf is attached to end and intermediate panels and back panels with 1" x 1" steel, black painted angle brackets and black #8 screws.

WORK SURFACE

Standard work surface is 1-3/16" thick, 3-ply, 45# density particleboard including a top surface of .050" thick, high-pressure laminate with a backing sheet not less than .020" thick for balanced construction. High-pressure laminate has a low-glare finish resistant to scratches, fading, and staining that meets or exceeds NEMA standards. Front edges of work surfaces have a 1-3/4" thick x 2"W solid oak external undercut chamfered edge band applied to the table core after lamination of the face plastic. The edge band is beveled at a 39° angle with 3/8" radius bullnosed at the leading edge. The back edge of the top has a black plastic strip 1-1/2"W which projects above the work surface 1/4" to act as a retainer.

END AND INTERMEDIATE PANELS

End and intermediate panels are 1-1/8" thick, 45# density particleboard core with select face veneers of Northern-grown red oak. The end panels on starter units receive the Chancellor's Collection veneer sketch face pattern on the outside face surface. These end panels also have the Chancellor's Collection solid red oak top edge cap. This wood cap measures 2-5/16"W x 1-1/4" thick and has a 3/8" radius on all four of the top edges. These edges also bevel downward at a 60° angle. All other edges are banded with a 1.6mm oak veneer band. Intermediate panels receive a 3" diameter grommet below the work surface to allow passage of electrical and data wires. Each panel receives two 1-1/4" adjustable glides.

BACK PANEL

Back panel is 3/4" thick, 45# density particleboard core with face veneers of select Northern-grown red oak. The top and bottom edges of the back panel receives 1.66mm veneer solid oak edge bands. Back panels attach to end and intermediate panels by means of recessed metal fasteners and shoulder screws. The back panel on double-faced units receive a 3" diameter grommet located below the work surface to allow passage of electrical and data wires.

SHELF

Shelf is 3/4" thick x 8"D 45# density particleboard core with face veneers of select Northern-grown red oak. Shelf is banded on the front edge with a 1.6mm solid oak band. Shelf attaches to end and intermediate panels by means of a pair of metal "L" brackets. Back corners of shelf have a 3" x 3" cutout to allow for the passage of electrical cords. The shelf is positioned 10" below the bottom of the work surface.

WIRE MANAGEMENT DOOR

The wire management door is positioned between the bottom of the work surface and the shelf and is designed to form a concealed wire management channel 8-1/2"H x 9-1/2"D. The door is 1/4" thick with select oak face veneers. The door slides in two aluminum tracks, one that is attached to the bottom of the work surface while the other is attached to the top of the shelf.

KNEE-SPACE PANEL

All 72" and 96"W workstations, as well as functional corner units, have a knee-space panel positioned under the work surface for additional work-surface support. Units 108"W have two knee-space panels. The knee-space panel is 1-1/8" thick, 45# density particleboard core with select face veneers of Northern-grown red oak. The panel is banded on exposed edges with a 1.6mm solid oak band. The knee-space panel is attached to the back panel using a 1-3/4" square, solid-oak post, grooved to receive the knee space panel and back panels. Panels attach to the post using recessed metal fasteners and shoulder screws. The knee-space panel is angled in the back to create a space to allow passage of electrical and data cords. The knee-space panel receives two 1-1/4" diameter black adjustable glides.

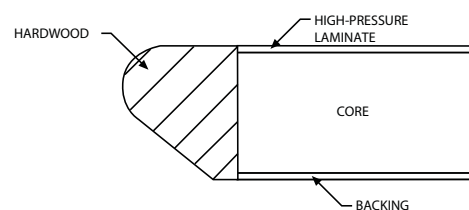

Chancellor's Series Edge Band

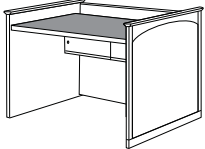
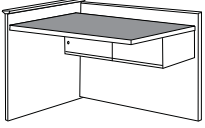
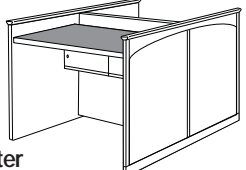
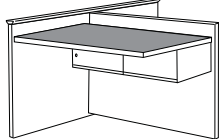
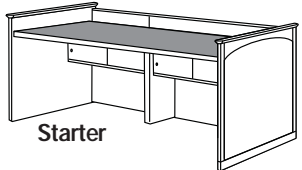
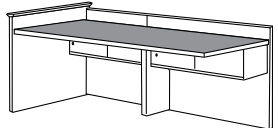
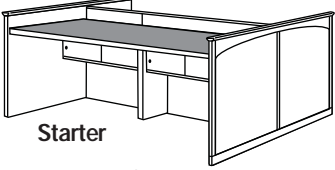
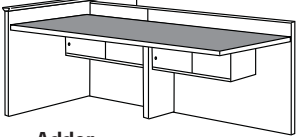
Oak Catalog No.	Maple Catalog No.	Description	H x W x D	Wt. (lbs.)	Oak Price	Maple Price	
<u>36" Wide Working Space</u>							Single-Faced One-Position
CH2-S31-SS0 OAK	CH2-S31-SS0 MAP	One-Position S/F Starter	36" x 37-1/2" x 31"	130	\$3,592	\$3,915	 <p>Starter</p>
CH2-S31-SAO OAK	CH2-S31-SAO MAP	One-Position S/F Adder	39" x 36-1/2" x 31"	100	\$2,383	\$2,598	
<u>48" Wide Working Space</u>							Adder
CH2-S41-SS0 OAK	CH2-S41-SS0 MAP	One-Position S/F Starter	36" x 49-1/4" x 31"	155	\$3,759	\$4,097	 <p>Adder</p>
CH2-S41-SAO OAK	CH2-S41-SAO MAP	One-Position S/F Adder	39" x 48" x 31"	125	\$2,444	\$2,664	
<u>36" Wide Working Space</u>							Double-Faced One-Position
CH2-D31-SS0 OAK	CH2-D31-SS0 MAP	One-Position D/F Starter	33-1/2" x 37-1/2" x 59-1/2"	215	\$5,380	\$5,864	 <p>Starter</p>
CH2-D31-SAO OAK	CH2-D31-SAO MAP	One-Position D/F Adder	33-1/2" x 36-1/2" x 59-1/2"	155	\$3,817	\$4,160	
<u>48" Wide Working Space</u>							Adder
CH2-D41-SS0 OAK	CH2-D41-SS0 MAP	One-Position D/F Starter	33-1/2" x 49-1/4" x 59-1/2"	255	\$5,662	\$6,172	 <p>Adder</p>
CH2-D41-SAO OAK	CH2-D41-SAO MAP	One-Position D/F Adder	33-1/2" x 48" x 59-1/2"	195	\$4,010	\$4,370	
<u>36" Wide Working Space</u>							Single-Faced Two-Position
CH2-S32-SS0 OAK	CH2-S32-SS0 MAP	Two-Position S/F Starter	33-1/2" x 74" x 31"	195	\$4,763	\$5,192	 <p>Starter</p>
CH2-S32-SAO OAK	CH2-S32-SAO MAP	Two-Position S/F Adder	33-1/2" x 73" x 31"	165	\$3,566	\$3,887	
<u>48" Wide Working Space</u>							Adder
CH2-S42-SS0 OAK	CH2-S42-SS0 MAP	Two-Position S/F Starter	33-1/2" x 97-1/4" x 31"	235	\$5,075	\$5,532	 <p>Adder</p>
CH2-S42-SAO OAK	CH2-S42-SAO MAP	Two-Position S/F Adder	33-1/2" x 96" x 31"	205	\$3,759	\$4,097	
<u>36" Wide Working Space</u>							Double-Faced Two-Position
CH2-D32-SS0 OAK	CH2-D32-SS0 MAP	Two-Position D/F Starter	33-1/2" x 74" x 59-1/2"	330	\$7,180	\$7,826	 <p>Starter</p>
CH2-D32-SAO OAK	CH2-D32-SAO MAP	Two-Position D/F Adder	33-1/2" x 73" x 59-1/2"	270	\$5,695	\$6,208	
<u>48" Wide Working Space</u>							Adder
CH2-D42-SS0 OAK	CH2-D42-SS0 MAP	Two-Position D/F Starter	33-1/2" x 97-1/4" x 59-1/2"	410	\$6,081	\$6,629	 <p>Adder</p>
CH2-D42-SAO OAK	CH2-D42-SAO MAP	Two-Position D/F Adder	33-1/2" x 96" x 59-1/2"	155	\$7,673	\$8,364	

Please specify Wood Finish (Table 1) and High-Pressure Laminate (Table 2). Details can be found on page GEN 4.

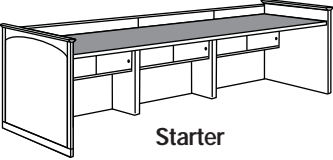
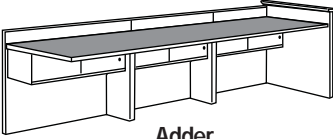
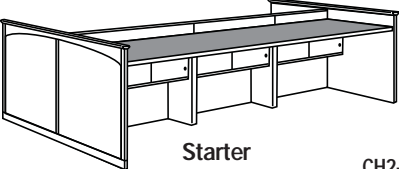
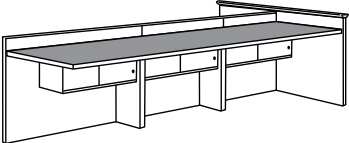
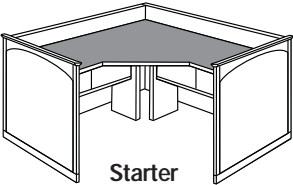
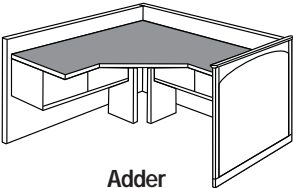
Starter	Adder	Oak Catalog No.	Maple Catalog No.	Description	H x W x D	Wt. (lbs.)	Oak Price	Maple Price
 <p>Starter</p>		CH2-S33-SS0 OAK	CH2-S33-SS0 MAP	Three-Position S/F Starter	36" x 110-1/2" x 31"	260	\$6,025	\$6,568
 <p>Adder</p>		CH2-S33-SA0 OAK	CH2-S33-SA0 MAP	Three-Position S/F Adder	36" x 109-1/4" x 31"	230	\$4,699	\$5,122
 <p>Starter</p>		CH2-D33-SS0 OAK	CH2-D33-SS0 MAP	Three-Position D/F Starter	36" x 110-1/2" x 59-1/2"	445	\$7,778	\$8,478
 <p>Adder</p>		CH2-D33-SA0 OAK	CH2-D33-SA0 MAP	Three Position D/F Adder	36" x 109-1/4" x 59-1/2"	385	\$9,267	\$10,101
 <p>Starter</p>		CH2-SCR-SS0 OAK	CH2-SCR-SS0 MAP	90-Degree Functional Corner Starter	36" x 62" x 31"	225	\$7,701	\$8,394
 <p>Adder</p>		CH2-SCR-SA0 OAK	CH2-SCR-SA0 MAP	90-Degree Functional Corner Adder	36" x 62" x 31"	195	\$6,348	\$6,919

Please specify Wood Finish (Table 1) and High-Pressure Laminate (Table 2). Details can be found on page GEN 4.

General Specifications

STATION TOP

Each top is 46-3/4"W at the front, tapering to 21-3/16" at the rear. **Tops are 28-3/4"D. A 1-1/2"W cord drop runs the width of the station** between the top and back panel to allow passage of electrical and data cords. Station tops are 1-3/16" thick, 45# density particleboard core including a top surface of .050" thick, high-pressure laminate and a backing sheet not less than .020" thick for balanced construction. High-pressure laminate has a low-glare finish resistant to scratches, fading, and staining in accordance with NEMA standards. The front edge of the top is banded with a 1-3/4" thick x 2"W solid-oak external undercut chamfered edge band laminated to the work surface core after lamination of the face plastic. **The edge band is beveled to a 3/8" radius bullnose at the leading edge. Bevel is at a 39° angle.**

END AND INTERMEDIATE PANELS

End and intermediate panels are 1-3/16" thick, 45# density particleboard core. Veneer on both faces of the panels is sketched to form a framed appearance. The "frame" is composed of 3-1/4" rift-cut, oak-veneer strips along both vertical edges and a 3-1/4" solid wood plinth at the bottom edge. At the top edge is a 3-1/4" rift-cut oak veneer strip shaped to form a 1-1/2"H internal arc. Within the frame is select plain-sliced, slip-matched ash veneer. The vertical edges of the end panel receives a 1.6mm solid-oak external edge band. The top edge of the panel receives a 2-1/4"W x 1-1/4"H solid-oak top cap. The top cap is 1-3/16"W at the bottom sloping outward on both sides at a 30° angle. **Both the front and back edges of the top cap receive a 3/8" radius. Each panel has two 1-1/4" diameter chrome adjustable glides with solid plinth.**

ELECTRICAL ACCESS DOOR (One for each 3- or 6- station unit)

Access door is 3/4" thick, comprised of select face veneers of Northern-grown red oak over a particleboard core. Panel is externally banded on all four sides with a 1.6mm thick solid-oak edge band. Door has a full-length hinge and a lock. Access door is located on one back panel, which can be located anywhere in the PAC station.

BACK PANEL

The back panel is 1-3/16" thick, 3-ply 45# density particleboard core with select plain-sliced, slip-matched oak veneer on both faces. The panel is internally banded with 1.6mm thick solid oak on both the bottom edge and the top edge. Back panels are attached to end and intermediate panels using hidden metal keyways and shoulder screws. Back panels have a 3" diameter grommets egress for electrical cords to pass to the center hub of half-hexagon or full-hexagon station configuration.

SHELVES

Shelves are 3/4" thick, select oak-veneered 45# density particleboard with a 5/8" thick x 1-3/4"H solid-oak front edge band.

CENTER CAP

The center cap is 3/4" thick, 45# density particleboard, with high-pressure laminate to match the tops, and shaped to enclose half-hexagon and full-hexagon station configurations.

WORKING SPACE

The working space is adjustable to: Standing Height 39", ADA Height 32" and Sitting Height 27".

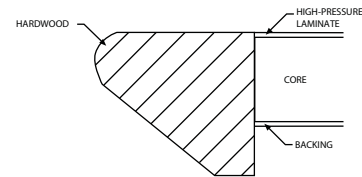

Chancellor's Series Drop Edge

Oak Catalog No.	Maple Catalog No.	Description	H x W x D	Wt. (lbs.)	Oak Price	Maple Price
CH2-682-S00 OAK	CH2-682-S00 MAP	Six position with angular tops.	43-1/2" x 98-1/2" x 98-1/2"	500	\$18,830	\$20,524

Six Position PAC Station

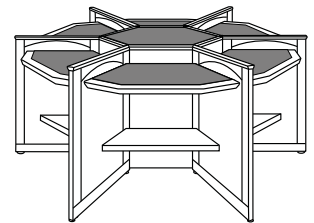

CH2-685-S00 OAK	CH2-685-S00 MAP	Three position with angular tops. Composed of one starter unit and two adder units.	43-1/2" x 98-1/2" x 47-1/2"	265	\$10,172	\$11,088
-----------------	-----------------	---	-----------------------------	-----	----------	----------

Three Position PAC Station

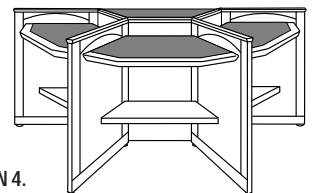

Please specify Wood Finish (Table 1) and High-Pressure Laminate (Table 2). Details can be found on page GEN 4.

General Specifications

TOPS

Tops are 1-3/16" thick, 3-ply 45# density particleboard including a top surface of .050" thick, high-pressure laminate with a backing sheet not less than .020" thick. Front edges are externally banded with a 1-3/16" thick x 1"W solid-oak undercut chamfered edge band applied to top core after lamination of the face plastic. The edge band is beveled at a 39° angle with a 3/8" radius bullnose at the leading edge. The back and side edges of top are straight and externally banded with a 1/4" thick oak band. Tops slope at an 8° angle. A 5/8" x 5/8" solid-oak book retainer strip is fastened to the top surface at the front of the sloped top.

END PANELS

End panels are 1-3/16" thick select, plain-sliced, oak-veneered 45# density particleboard. The inside face of end panels is select plain-sliced, slip-matched oak veneer. Veneer on the outside face of end panels is sketched to form a "framed" appearance. The "frame" is composed of 3-1/4" rift-cut, oak veneer strips along both vertical edges and a 3-1/4" solid wood plinth at the bottom edge. At the top edge is a 3-1/4" rift-cut oak veneer strip shaped to form a 1-1/2"W internal arc. Within the frame is select plain-sliced, slip-matched ash veneer. The vertical edges of the end panel receive a 1.6mm solid oak external edge band. Each panel has two 1-1/4" diameter chrome adjustable glides.

BACK PANEL

The back panel is 3/4" thick select, plain-sliced, oak-veneered 45# density particleboard banded on the bottom.

DICTIONARY STAND SHELVES

Dictionary stands have one adjustable and one fixed base shelf. Shelves are 3/4" thick, oak-veneered plywood having a 1.6mm veneer edge band.

ATLAS STAND SHELVES

Atlas stands have five pullout shelves. Pullout shelves are 3/4" thick, oak-veneered plywood. Front edges of each shelf have a 2-1/4" x 3/4" solid-oak hardwood fascia. Shelves operate on metal slides with nylon rollers. Each shelf has an automatic shelf stop to prevent accidental removal.

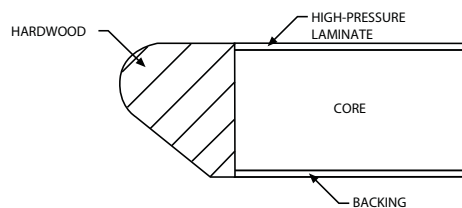

Chancellor's Series Edge

	Oak Catalog No.	Maple Catalog No.	Description	H x W x D	Wt. (lbs.)	Oak Price	Maple Price
Dictionary Stand	CH2-869-S00 OAK	CH2-869-S00 MAP	Dictionary Stand	45" x 25-7/8" x 15-3/4"	200	\$2,826	\$3,080



Atlas Stand	CH2-871-S00 OAK	CH2-871-S00 MAP	Atlas Stand	45" x 29-1/4" x 29-3/4"	250	\$4,581	\$4,994
-------------	-----------------	-----------------	-------------	-------------------------	-----	---------	---------



Please specify Wood Finish (Table 1) and High-Pressure Laminate (Table 2). Details can be found on page GEN 4.

Oak Catalog No.	Maple Catalog No.	Description	Wt. (lbs.)	Oak Price	Maple Price
<u>To Cover ONE UNIT</u>					
CH2-W10-S01 OAK	CH2-W10-S01 MAP	10"D, Single-Faced	11	\$376	\$395
CH2-W12-S01 OAK	CH2-W12-S01 MAP	12"D, Single-Faced	14	\$398	\$418
CH2-W20-S01 OAK	CH2-W20-S01 MAP	20"D, Double-Faced	23	\$653	\$685
CH2-W24-S01 OAK	CH2-W24-S01 MAP	24"D, Double-Faced	27	\$697	\$732
<u>To Cover TWO UNITS</u>					
CH2-W10-S02 OAK	CH2-W10-S02 MAP	10"D, Single-Faced	22	\$515	\$541
CH2-W12-S02 OAK	CH2-W12-S02 MAP	12"D, Single-Faced	28	\$558	\$585
CH2-W20-S02 OAK	CH2-W20-S02 MAP	20"D, Double-Faced	46	\$920	\$966
CH2-W24-S02 OAK	CH2-W24-S02 MAP	24"D, Double-Faced	54	\$1,019	\$1,070
<u>To Cover THREE UNITS</u>					
CH2-W10-S03 OAK	CH2-W10-S03 MAP	10"D, Single-Faced	33	\$642	\$674
CH2-W12-S03 OAK	CH2-W12-S03 MAP	12"D, Single-Faced	42	\$714	\$750
CH2-W20-S03 OAK	CH2-W20-S03 MAP	20"D, Double-Faced	69	\$1,244	\$1,306
CH2-W24-S03 OAK	CH2-W24-S03 MAP	24"D, Double-Faced	81	\$1,291	\$1,355
<u>To Cover FOUR UNITS</u>					
CH2-W10-S04 OAK	CH2-W10-S04 MAP	10"D, Single-Faced	44	\$867	\$910
CH2-W12-S04 OAK	CH2-W12-S04 MAP	12"D, Single-Faced	56	\$956	\$1,004
CH2-W20-S04 OAK	CH2-W20-S04 MAP	20"D, Double-Faced	92	\$1,551	\$1,628
CH2-W24-S04 OAK	CH2-W24-S04 MAP	24"D, Double-Faced	108	\$1,748	\$1,835
<u>To Cover FIVE UNITS</u>					
CH2-W10-S05 OAK	CH2-W10-S05 MAP	10"D, Single-Faced	55	\$983	\$1,032
CH2-W12-S05 OAK	CH2-W12-S05 MAP	12"D, Single-Faced	70	\$1,114	\$1,170
CH2-W20-S05 OAK	CH2-W20-S05 MAP	20"D, Double-Faced	115	\$1,875	\$1,969
CH2-W24-S05 OAK	CH2-W24-S05 MAP	24"D, Double-Faced	135	\$2,019	\$2,120
<u>To Cover SIX UNITS</u>					
CH2-W10-S06 OAK	CH2-W10-S06 MAP	10"D, Single-Faced	66	\$1,125	\$1,181
CH2-W12-S06 OAK	CH2-W12-S06 MAP	12"D, Single-Faced	84	\$1,269	\$1,332
CH2-W20-S06 OAK	CH2-W20-S06 MAP	20"D, Double-Faced	138	\$2,202	\$2,313
CH2-W24-S06 OAK	CH2-W24-S06 MAP	24"D, Double-Faced	162	\$2,292	\$2,406
<u>To Cover SEVEN UNITS</u>					
CH2-W10-S07 OAK	CH2-W10-S07 MAP	10"D, Single-Faced	77	\$1,348	\$1,416
CH2-W12-S07 OAK	CH2-W12-S07 MAP	12"D, Single-Faced	98	\$1,511	\$1,586
CH2-W20-S07 OAK	CH2-W20-S07 MAP	20"D, Double-Faced	161	\$2,505	\$2,630
CH2-W24-S07 OAK	CH2-W24-S07 MAP	24"D, Double-Faced	189	\$2,749	\$2,886
<u>To Cover EIGHT UNITS</u>					
CH2-W10-S08 OAK	CH2-W10-S08 MAP	10"D, Single-Faced	88	\$1,478	\$1,552
CH2-W12-S08 OAK	CH2-W12-S08 MAP	12"D, Single-Faced	112	\$1,668	\$1,751
CH2-W20-S08 OAK	CH2-W20-S08 MAP	20"D, Double-Faced	184	\$2,831	\$2,973
CH2-W24-S08 OAK	CH2-W24-S08 MAP	24"D, Double-Faced	216	\$3,005	\$3,155
<u>To Cover NINE UNITS</u>					
CH2-W10-S09 OAK	CH2-W10-S09 MAP	10"D, Single-Faced	99	\$1,650	\$1,732
CH2-W12-S09 OAK	CH2-W12-S09 MAP	12"D, Single-Faced	126	\$1,868	\$1,961
CH2-W20-S09 OAK	CH2-W20-S09 MAP	20"D, Double-Faced	207	\$3,201	\$3,361
CH2-W24-S09 OAK	CH2-W24-S09 MAP	24"D, Double-Faced	243	\$3,336	\$3,503

Note: Single-Faced Tops are banded on both ends and on the front edge only. Back edge is not banded.
Double-Faced Tops are banded on both ends and on the front and back edges.

Please specify Wood Finish (Table 1) and High-Pressure Laminate (Table 2). Details can be found on page GEN 4.

Oak Catalog No.	Maple Catalog No.	Description	Wt. (lbs.)	Oak Price	Maple Price
<i>To Cover ONE UNIT</i>					
CH2-S10-S01 OAK	CH2-S10-S01 MAP	10"D, Single-Faced	11	\$376	\$395
CH2-S12-S01 OAK	CH2-S12-S01 MAP	12"D, Single-Faced	14	\$398	\$418
CH2-S20-S01 OAK	CH2-S20-S01 MAP	20"D, Double-Faced	23	\$653	\$685
CH2-S24-S01 OAK	CH2-S24-S01 MAP	24"D, Double-Faced	27	\$697	\$732
<i>To Cover TWO UNITS</i>					
CH2-S10-S02 OAK	CH2-S10-S02 MAP	10"D, Single-Faced	22	\$515	\$541
CH2-S12-S02 OAK	CH2-S12-S02 MAP	12"D, Single-Faced	28	\$558	\$585
CH2-S20-S02 OAK	CH2-S20-S02 MAP	20"D, Double-Faced	46	\$920	\$966
CH2-S24-S02 OAK	CH2-S24-S02 MAP	24"D, Double-Faced	54	\$1,019	\$1,070
<i>To Cover THREE UNITS</i>					
CH2-S10-S03 OAK	CH2-S10-S03 MAP	10"D, Single-Faced	33	\$642	\$674
CH2-S12-S03 OAK	CH2-S12-S03 MAP	12"D, Single-Faced	42	\$714	\$750
CH2-S20-S03 OAK	CH2-S20-S03 MAP	20"D, Double-Faced	69	\$1,244	\$1,306
CH2-S24-S03 OAK	CH2-S24-S03 MAP	24"D, Double-Faced	81	\$1,291	\$1,355
<i>To Cover FOUR UNITS</i>					
CH2-S10-S04 OAK	CH2-S10-S04 MAP	10"D, Single-Faced	44	\$867	\$910
CH2-S12-S04 OAK	CH2-S12-S04 MAP	12"D, Single-Faced	56	\$956	\$1,004
CH2-S20-S04 OAK	CH2-S20-S04 MAP	20"D, Double-Faced	92	\$1,551	\$1,628
CH2-S24-S04 OAK	CH2-S24-S04 MAP	24"D, Double-Faced	108	\$1,748	\$1,835
<i>To Cover FIVE UNITS</i>					
CH2-S10-S05 OAK	CH2-S10-S05 MAP	10"D, Single-Faced	55	\$983	\$1,032
CH2-S12-S05 OAK	CH2-S12-S05 MAP	12"D, Single-Faced	70	\$1,114	\$1,170
CH2-S20-S05 OAK	CH2-S20-S05 MAP	20"D, Double-Faced	115	\$1,875	\$1,969
CH2-S24-S05 OAK	CH2-S24-S05 MAP	24"D, Double-Faced	135	\$2,019	\$2,120
<i>To Cover SIX UNITS</i>					
CH2-S10-S06 OAK	CH2-S10-S06 MAP	10"D, Single-Faced	66	\$1,125	\$1,181
CH2-S12-S06 OAK	CH2-S12-S06 MAP	12"D, Single-Faced	84	\$1,269	\$1,332
CH2-S20-S06 OAK	CH2-S20-S06 MAP	20"D, Double-Faced	138	\$2,202	\$2,313
CH2-S24-S06 OAK	CH2-S24-S06 MAP	24"D, Double-Faced	162	\$2,292	\$2,406
<i>To Cover SEVEN UNITS</i>					
CH2-S10-S07 OAK	CH2-S10-S07 MAP	10"D, Single-Faced	77	\$1,348	\$1,416
CH2-S12-S07 OAK	CH2-S12-S07 MAP	12"D, Single-Faced	98	\$1,511	\$1,586
CH2-S20-S07 OAK	CH2-S20-S07 MAP	20"D, Double-Faced	161	\$2,505	\$2,630
CH2-S24-S07 OAK	CH2-S24-S07 MAP	24"D, Double-Faced	189	\$2,749	\$2,886
<i>To Cover EIGHT UNITS</i>					
CH2-S10-S08 OAK	CH2-S10-S08 MAP	10"D, Single-Faced	88	\$1,478	\$1,552
CH2-S12-S08 OAK	CH2-S12-S08 MAP	12"D, Single-Faced	112	\$1,668	\$1,751
CH2-S20-S08 OAK	CH2-S20-S08 MAP	20"D, Double-Faced	184	\$2,831	\$2,973
CH2-S24-S08 OAK	CH2-S24-S08 MAP	24"D, Double-Faced	216	\$3,005	\$3,155
<i>To Cover NINE UNITS</i>					
CH2-S10-S09 OAK	CH2-S10-S09 MAP	10"D, Single-Faced	99	\$1,650	\$1,732
CH2-S12-S09 OAK	CH2-S12-S09 MAP	12"D, Single-Faced	126	\$1,868	\$1,961
CH2-S20-S09 OAK	CH2-S20-S09 MAP	20"D, Double-Faced	207	\$3,201	\$3,361
CH2-S24-S09 OAK	CH2-S24-S09 MAP	24"D, Double-Faced	243	\$3,336	\$3,503

Note: Edge Band on long side only. Tops are designed to be inset between end panels. If edge bands are desired on short edges, please enter the part as a modification and specify which bands to be included.

To ensure that tops for steel shelving work with each manufacturer and top method, please specify the exact width and depth of tops. Add 15% for HPL on top and bottom (Steel Shelving ONLY).

Please specify Wood Finish (Table 1) and High-Pressure Laminate (Table 2). Details can be found on page GEN 4.



General Specifications

END PANELS: STEEL SHELVING

End panels are 1-3/16" thick, 3-ply 45# density particleboard core with select plain-sliced, slip-matched oak veneer on the inside face. Oak veneer on outside face of end panels is sketched to form a "framed" appearance. The "frame" is composed of 3-1/4" rift-cut, oak-veneer strips along both vertical edges and a 3-1/4" solid wood plinth at the bottom edge. At the top edge is a 3-1/4" rift-cut oak veneer strip shaped to form a 1-1/2"H internal arc. Within the frame is select plain-sliced, slip-matched ash veneer. The vertical edges of the end panel receives a 1.6mm solid oak external edge band. The top edge of the panel receives

a 1-3/4"W x 1-1/4"H solid oak top cap. The top cap is 1-3/16"W at the bottom sloping outward at a 30° angle. Both ends of the top cap receive a 3/8" radius. The vertical edges of the end panel receive a 1.6mm solid-oak external edge band. All panel edges are eased. Exact height and depth of panel must be specified when ordering. End panels are not machined. No fastening hardware is provided with end panels.

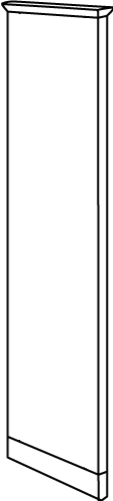
Note: Please use the part number below and specify exact sizes of end panels and whether continuous tops are to be "inset" (between the panels) or overhung out over the panels.

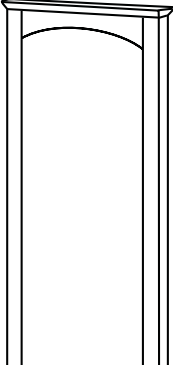
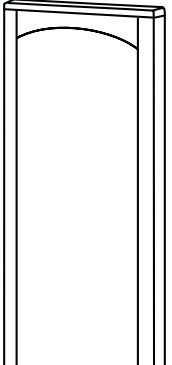
Oak Catalog No.	Maple Catalog No.	Description	Wt. (lbs.)	Oak Price	Maple Price	With Top Caps	Without Top Caps		
CH2-702-MOD OAK	CH2-702-MOD MAP	43-3/4" x 13-7/8"	10	\$634	\$667				
CH2-703-MOD OAK	CH2-703-MOD MAP	43-3/4" x 15-7/8"	12	\$655	\$688				
CH2-705-MOD OAK	CH2-705-MOD MAP	67-3/4" x 13-7/8"	16	\$725	\$761				
CH2-706-MOD OAK	CH2-706-MOD MAP	67-3/4" x 15-7/8"	19	\$757	\$795				
CH2-708-MOD OAK	CH2-708-MOD MAP	79-3/4" x 13-7/8"	15	\$786	\$825				
CH2-709-MOD OAK	CH2-709-MOD MAP	79-3/4" x 15-7/8"	24	\$822	\$864				
CH2-711-MOD OAK	CH2-711-MOD MAP	85-3/4" x 13-7/8"	18	\$815	\$856				
CH2-712-MOD OAK	CH2-712-MOD MAP	85-3/4" x 15-7/8"	27	\$866	\$909				
CH2-714-MOD OAK	CH2-714-MOD MAP	91-3/4" x 13-7/8"	20	\$852	\$895				
CH2-715-MOD OAK	CH2-715-MOD MAP	91-3/4" x 15-7/8"	29	\$901	\$945				
								Single-Faced End Panels	
CH2-722-MOD OAK	CH2-722-MOD MAP	43-3/4" x 24-3/8"	20	\$794	\$833				
CH2-723-MOD OAK	CH2-723-MOD MAP	43-3/4" x 28-3/8"	24	\$825	\$867				
CH2-725-MOD OAK	CH2-725-MOD MAP	67-3/4" x 24-3/8"	32	\$946	\$994				
CH2-726-MOD OAK	CH2-726-MOD MAP	67-3/4" x 28-3/8"	38	\$1,019	\$1,070				
CH2-728-MOD OAK	CH2-728-MOD MAP	79-3/4" x 24-3/8"	30	\$1,042	\$1,094				
CH2-729-MOD OAK	CH2-729-MOD MAP	79-3/4" x 28-3/8"	48	\$1,128	\$1,184				
CH2-731-MOD OAK	CH2-731-MOD MAP	85-3/4" x 24-3/8"	36	\$1,087	\$1,142				
CH2-732-MOD OAK	CH2-732-MOD MAP	85-3/4" x 28-3/8"	54	\$1,188	\$1,247				
CH2-734-MOD OAK	CH2-734-MOD MAP	91-3/4" x 24-3/8"	40	\$1,142	\$1,199				
CH2-735-MOD OAK	CH2-735-MOD MAP	91-3/4" x 28-3/8"	58	\$1,241	\$1,303				
						Double-Faced End Panels			

Note: Heights noted do NOT include the top cap. End panels that are to have continuous tops overhung will NOT receive a top cap.

Please specify Wood Finish (Table 1). Details can be found on page GEN 4.

General Specifications

CHAIR FRAME

The end frames are constructed of legs that are 1-1/4" thick x 2-1/2"W, and a top arm rail that is 1" thick by 2-1/2"W. All parts are constructed from solid oak. All joints are mortised, tenoned, and glued to form a solid unit. Within the end frame is a 1" thick, 45# density particleboard core, veneered panel. The panel is flush to the inside of the end frame leaving a 1/4" inset reveal on the outside face of the frame. The inside face of the end panel receives select plain-sliced, slip-matched oak veneer. The veneer on the outside face of the panel is sketched to form a "framed" appearance. The frame is composed of a horizontal 2-1/2" rift-cut, oak-veneer strip along the bottom edge of the panel, and a horizontal 3-1/4"W rift-cut oak-veneer strip along the top edge, shaped to form a 1-1/2"H internal arc. The solid oak legs of the end frames form the vertical sides of the "frame". Within the frame is select plain-sliced, slip-matched ash veneer. The front stretcher and front seat rail are 3"W x 1" thick solid red oak. The back seat rail is 2-3/4"W x 1" thick solid red oak. The cross stretcher and seat rails are mortised, tenoned, and glued into the side frames.

UPHOLSTERED SEAT AND BACK

The seat and back frame are a single piece of 3/4" bent plywood. The seat portion is fitted with a Dimatrol Webbing and then covered with black cambric fabric for comfort. This is then covered with 3-1/2" foam, which is also used on the chair back. The entire seat and back assembly is covered with the specified upholstery fabric except for the underside of the seat which is covered with a black cambric fabric. Brodart upholstery materials meet requirements of the following fire codes: Calif. Technical Bulletin #117 (sec. E part 1); CS-191-53 class 1. Fabrics which meet Calif. Technical Bulletin #133 are available.

TABLETOPS

Tabletops are 1-3/16" thick, 3-ply, 45# density particleboard core with a .050" high-pressure laminate face and a .020" thick backing sheet on the underside. High-pressure laminate has a lo-glare finish resistant to scratches, fading, and staining in accordance with NEMA standards. Tabletops are banded on exposed edges with a 1-3/4" thick x 2"W solid-oak external undercut chamfered edge band applied to the table core after lamination of the face plastic. The edge band is beveled at a 39° angle with a 3/8" radius bullnose at the leading edge. Square and rectangular tabletop edge bands are mitered at all four corners and corners radiused 1/8".

TABLE LEGS

Table legs are 2-1/2"W, square shape, glued up face to face from three solid-oak blanks. All glue joints are tight and smooth. All vertical edges receive a 1/4" radius. Legs receive a horizontal vein line 5/32"W x 3/32"D on the two outside faces of the leg positioned 3-11/32" below the top of the legs. This vein line matches the horizontal vein line on the apron. An identical vein line is positioned 3-1/4" above the bottom of the leg. At the bottom of this vein line the two back sides of the leg taper to a dimension of 1-7/8" x 1-7/8" at the bottom of the leg. Legs receive a 1-1/2" diameter adjustable glide mounted in a recessed tee-nut. The glide is further recessed into the leg by means of a countersunk boring which accepts the upper two-thirds of the glide. Table is an apron design with a 3-1/2" x 1" thick apron screwed to the underside of the tabletop. A 5/32"W x 3/32"D vein line is positioned at the bottom front surface of the apron to mirror the top horizontal vein line on the table leg. The legs attach to the aprons by means of formed 14-gauge steel corner brackets. Each leg is bolted to the corner bracket with two 5/16" - 18 hex-head bolts which pass through the bracket and engage threaded bushings embedded into the leg and cross-pinned with a 3/16" diameter steel pin.

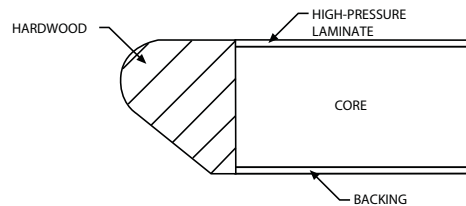

Chancellor's Series Edge

Lounge Seating

The Chancellor's Collections

Catalog No.	Overall H x W x D	Wt. (lbs.)	COM Price	Wood/G1 Price	Grade 2 Price	Grade 3 Price	Grade 4 Price	Grade 5 Price
-------------	----------------------	---------------	--------------	------------------	------------------	------------------	------------------	------------------

One Seat Lounge, Oak Wood

CH2-101-S00 OAK	31" x 29-1/2" x 29-3/8"	65	\$2,463	\$2,375	\$2,994	\$3,181	\$3,466	\$3,665
-----------------	-------------------------	----	---------	---------	---------	---------	---------	---------

One Seat Lounge, Maple Wood

CH2-101-S00 MAP	31" x 29-1/2" x 29-3/8"	65	\$2,759	\$2,660	\$3,353	\$3,563	\$3,882	\$4,105
-----------------	-------------------------	----	---------	---------	---------	---------	---------	---------

Fabric Requirements: 2 yards per chair, Non-directional, 54" wide.

One Seat

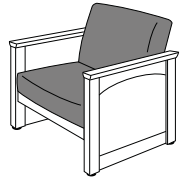

Two Seat Lounge, Oak Wood

CH2-201-S00 OAK	31" x 53-1/2" x 29-3/8"	110	\$3,488	\$3,310	\$4,553	\$4,875	\$4,832	\$5,110
-----------------	-------------------------	-----	---------	---------	---------	---------	---------	---------

Two Seat Lounge, Maple Wood

CH2-201-S00 MAP	31" x 53-1/2" x 29-3/8"	110	\$3,907	\$3,706	\$5,099	\$5,460	\$5,413	\$5,723
-----------------	-------------------------	-----	---------	---------	---------	---------	---------	---------

Fabric Requirements: 4 yards per chair, Non-directional, 54" wide.

Two Seat

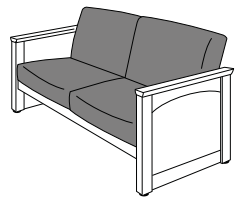

Three Seat Lounge, Oak Wood

CH2-301-S00 OAK	31" x 77-7/8" x 29-3/8"	162	\$4,401	\$4,133	\$5,998	\$6,480	\$6,035	\$6,382
-----------------	-------------------------	-----	---------	---------	---------	---------	---------	---------

Three Seat Lounge, Maple Wood

CH2-301-S00 MAP	31" x 77-7/8" x 29-3/8"	162	\$4,928	\$4,630	\$6,718	\$7,258	\$6,759	\$7,148
-----------------	-------------------------	-----	---------	---------	---------	---------	---------	---------

Fabric Requirements: 6 yards per chair, Non-directional, 54" wide.

Three Seat

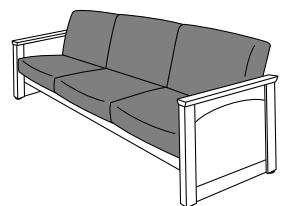

Please specify Wood Finish (Table 1) and Upholstery (Table 5). Details can be found on pages GEN 4 and GEN 5.

	Oak Catalog No.	Maple Catalog No.	Description	H x W x D	Wt. (lbs.)	Oak Price	Maple Price
Round Table	<u>Table with Chamfered Square Legs with Apron</u>						
	CH2-610-S00 OAK	CH2-610-S00 MAP	Round Table	16"H x 38" Diameter	70	\$1,854	\$2,076

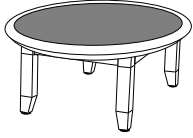

Square Table	<u>Table with Chamfered Square Legs with Apron</u>						
	CH2-621-S00 OAK	CH2-621-S00 MAP	Square Table	16" x 32" x 32"	47	\$1,554	\$1,740

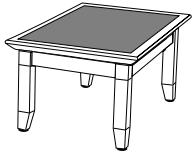

Rectangular Table	<u>Table with Chamfered Square Legs with Apron</u>						
	CH2-611-S00 OAK	CH2-611-S00 MAP	Rectangular Table	16" x 50" x 26"	60	\$1,450	\$1,624



Please specify Wood Finish (Table 1) and High-Pressure Laminate (Table 2). Details can be found on page GEN 4.

The Epoch Collection



2017 Price List and Specifications

Brodart Co. Contract Furniture - Made in USA

280 North Road, Clinton County Industrial Park • McElhattan, PA 17748

Toll-Free: 888-521-1884 • E-Mail: furniture@brodart.com • www.brodartfurniture.com

General Specifications

DESKTOP

Standard desktops are 1-3/16" thick 3-ply, 45# density, particleboard core, with a top surface of .050" thick, high-pressure laminate, with a backing sheet not less than .020" thick for balanced construction. High-pressure laminate has a lo-glare finish resistant to scratches, fading, and staining that meets or exceeds NEMA standards. Tops receive a 2"W x 1-3/4" T solid Northern-grown hard maple edge band on the patron side, and edges beveled down at a 20° angle with a 1/2" radius at the leading edge forming a bullnose shape. A 1/4" thick, solid Northern-grown hard maple edge band is applied to the remaining three sides, with top and bottom edges radiused to 1/8". All edges are applied to the desktop after the top and bottom laminate sheets are applied, constituting an external edge band. Desktops are positioned over the end panels of the desk module, flush with the outside edges of the end panels.

UPRIGHT UNIT PANELS

Desk module end panels are 1" thick, 3-ply, 45# density particleboard core with select plain-sliced maple veneers on both sides. Exposed edges are externally banded with a 1" x 1/16" thick, solid Northern-grown maple edge band. The end panels and front panel are joined and secured with 3/4" x 3/4" thick solid hardwood cleats screwed to the inside surfaces of the panels. The bottom of each end panel receives two adjustable glides to allow leveling of the individual units. Each end panel receives a 3" diameter egress and grommet to provide for wire passage.

FRONT PANELS

The front panel is 3/4" thick, comprised of the select plain-sliced face veneers of Northern-grown maple over a 45# density particleboard core. Exposed edges are externally banded with a 3/4" x 1.6 mm thick, solid Northern-grown maple edge band. The front incorporates a 6"H x 3/4"D recessed, ebonized, toe space at the bottom of the panel. The front panel is positioned over the end panels of the desk module, flush with the outside edges of the end panels. Doublewide units have two front panels to give the appearance of two individual units, for a uniform look.

OFFSET RESIN PANEL FRONT DESIGN

A tinted, 1/4" thick resin panel accent is attached to the front panels 12"H. Single units have one resin panel accent, while double and square corner units have two. The resin panel is held back 1" from each end of the unit. A 2-1/2" diameter x 1/2" thick metal cap nut is used to bolt the resin panel to the front panel, a felt or rubber washer is used against both surfaces of the resin panel, and loc-tite is used on the bolt to keep the cap nut from turning after positioned. The cap nuts are centered in 3-1/2" from the end of the resin panel and down 3" and 4-1/2". There are four cap nuts on each piece of resin panel (Also see tinted resin panel specifications). The cap nuts are chrome plated or powder-coated as specified (see chrome specifications).

CHROME/POWDER COAT DESIGN

A steel bar 1/4" thick x 1-1/4"W is recessed 3/16"D down 3-5/16" from the top of the front panel and run from the left edge to the right edge, and 1-1/2" down from the bottom of this bar a second bar is recessed 3/16"D into the front panel. This second bar is like the first bar except it has a 6" x 1-1/4" x 1/4" protrusion, centered and welded in place and pointing down when placed on the front. Each bar is glued in place so it cannot be removed. The bars are either chrome plated or power-coated as specified. (See chrome specifications).

ADJUSTABLE WORK SURFACE

Work surfaces are 1-3/16" thick, 3-ply particleboard core, including a top surface of .050" thick, high-pressure laminate with a backing sheet not less than .020" thick for balanced construction. High-pressure laminate has a lo-glare finish resistant to scratches, fading, and staining that meets or exceeds NEMA standards.

The exposed edge receives a 5/8" thick solid Northern-grown red oak internal edge band in a straight design. The back of the work surface has a black plastic band 1-1/2"W, which projects above the work surface 1/4" to act as a retainer. The work surface is 24-1/2"D and is positioned 1-1/2" away from the front panel, creating a cord drop space. Adjustable work surfaces are available in single wide standing height desks. Work surfaces in standing-height desks (catalog number 73-012) may be positioned at heights of 36", 32", or 27".

CHROME PLATING SPECIFICATION

Where "chrome plated" is specified, Brodart uses a decorative chromium electro-plated finish, which protects against tarnish and minimizes scratching.

Brodart Class AA chrome plating requires a .004" to .005" thick layer of bright nickel and a layer of chromium to produce a high-quality furniture grade finish.

OFFSET RESIN PANEL SPECIFICATIONS

Unless otherwise specified all offset resin panels are 1/4" thick. The customer must specify the tint color that they require from those offered by Brodart.

The offset resin panel is held in place by 1/4" thick solid wood maple molding on both sides of the resin which is sanded flush with the panel surfaces.

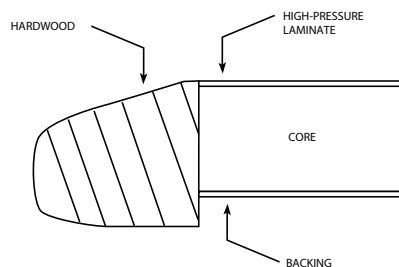

Epoch Series Edge

General Specifications

SHELVES

Shelves are constructed of 7-ply, furniture grade hardwood veneer-core plywood, with plain-sliced maple face veneer. Exposed edges receive a 1/4" thick, solid maple edge band.

DRAWERS

Drawers are constructed of solid hardwood with a 1/4" thick wood bottom panel. Drawers have 3-ply particleboard fronts with select maple face veneer. Box drawers have extension slides with 100# load capacity. File drawers have full-extension slides with 100# load capacity.

DESK DIMENSIONS

Standing-Height Desk, overall: 39-3/16"H x 35"W x 31-3/8"D or 39-3/16"H x 70"W x 31-3/8"D.

Sitting-Height Desk, overall: 32-3/16"H x 35"W x 31-3/8"D or 32-3/16"H x 70"W x 31-3/8"D.

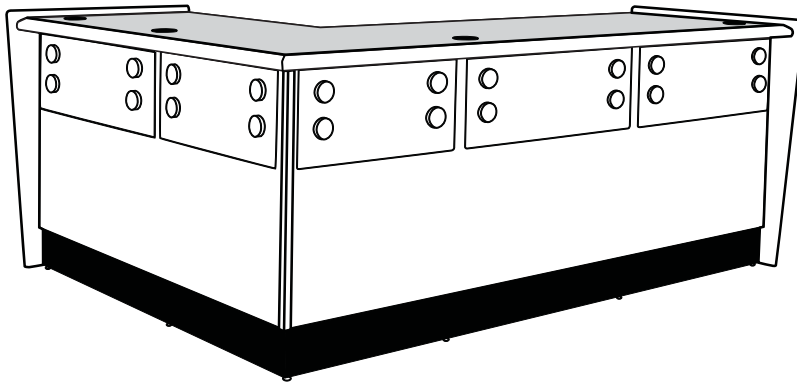

Offset Resin Panel Design

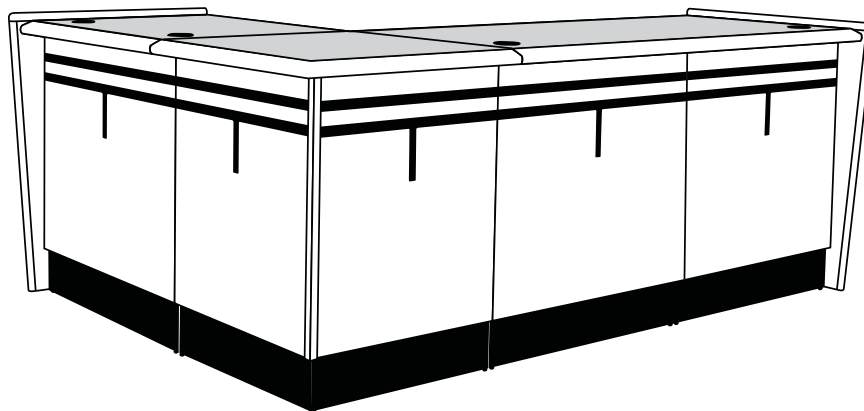
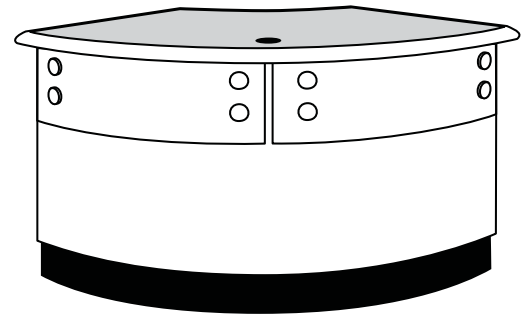

Metal "T" Front Design

The Epoch Collection

Circulation Desks with Offset Resin Panel Fronts, Single-Wide

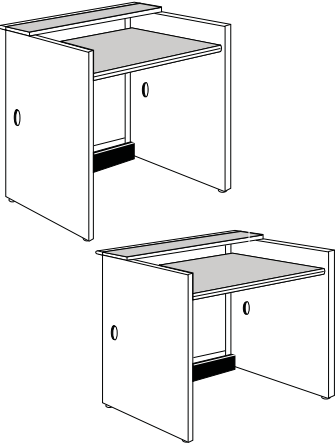
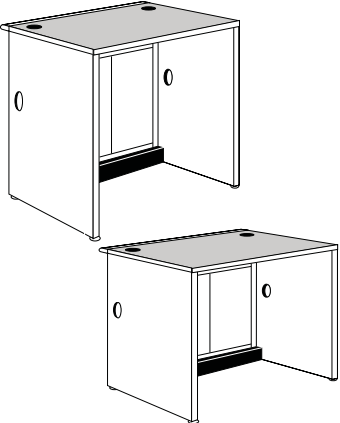
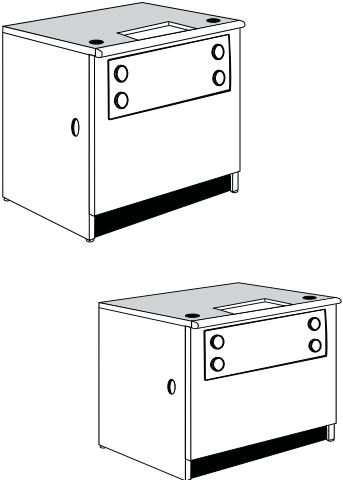
Standing	Sitting	Oak Catalog No.	Maple Catalog No.	Description	H x W x D	Wt. (lbs.)	Oak Price	Maple Price
Single-Wide Desk with Patron Service Ledge		59-012-S02 OAK	59-012-S02 MAP	Desk w/Painted Resin Panel Front	39-3/16" x 35" x 31-3/8"	140	\$3,544	\$3,862
		59-012-S00 OAK	59-012-S00 MAP	Desk w/Chrome Resin Panel Front	39-3/16" x 35" x 31-3/8"	140	\$3,827	\$4,171
		59-E12-S02 OAK	59-E12-S02 MAP	Desk w/Painted Resin Panel Front	32-3/16" x 35" x 31-3/8"	125	\$3,293	\$3,589
		59-E12-S00 OAK	59-E12-S00 MAP	Desk w/Chrome Resin Panel Front	32-3/16" x 35" x 31-3/8"	125	\$3,558	\$3,878
				Inside dimensions: 33"W x 26-3/4"D. The 7-7/8" patron ledge is at a standing height of 39-3/16"H. Note: Adjustable-height work surface may be positioned at heights of 36", 32" or 27".				
				Inside dimensions: 33"W x 26-3/4"D. The 7-7/8" patron ledge is at a sitting height of 32-3/16"H. Note: Work surface is fixed at 27"H.				
Single-Wide Desk without Patron Service Ledge		59-014-S02 OAK	59-014-S02 MAP	Desk w/Painted Resin Panel Front	39-3/16" x 35" x 31-3/8"	135	\$3,421	\$3,729
		59-014-S00 OAK	59-014-S00 MAP	Desk w/Chrome Resin Panel Front	39-3/16" x 35" x 31-3/8"	135	\$3,693	\$4,025
		59-E14-S02 OAK	59-E14-S02 MAP	Desk w/Painted Resin Panel Front	32-3/16" x 35" x 31-3/8"	120	\$3,251	\$3,544
		59-E14-S00 OAK	59-E14-S00 MAP	Desk w/Chrome Resin Panel Front	32-3/16" x 35" x 31-3/8"	120	\$3,510	\$3,825
				Inside dimensions: 33"W x 26-3/4"D. The work surface is at a standing height of 39-3/16"H. Two 3" diameter grommets are located in the work surface.				
				Inside dimensions: 33"W x 26-3/4"D. The work surface is at a sitting height of 32-3/16"H. Two 3" diameter grommets are located in the work surface.				
Book Return Unit		59-015-S02 OAK	59-015-S02 MAP	Desk w/Painted Resin Panel Front	39-3/16" x 35" x 31-3/8"	135	\$3,944	\$4,298
		59-015-S00 OAK	59-015-S00 MAP	Desk w/Chrome Resin Panel Front	39-3/16" x 35" x 31-3/8"	135	\$4,259	\$4,642
		59-E15-S02 OAK	59-E15-S02 MAP	Desk w/Painted Resin Panel Front	32-3/16" x 35" x 31-3/8"	120	\$3,727	\$4,062
		59-E15-S00 OAK	59-E15-S00 MAP	Desk w/Chrome Resin Panel Front	32-3/16" x 35" x 31-3/8"	120	\$4,026	\$4,388
				Inside dimensions: 33"W x 26-3/4"D. The work surface is at a standing height 39-3/16"H. Unit has a 5"H x 12"W finished opening centered in the front panel for passage of books and a book chute to direct the books over a mobile depressible book truck. (Depressible book truck not included). Two 3" diameter grommets are located in the work surface.				
				Inside dimensions: 33"W x 26-3/4"D. The work surface is at a sitting height 32-3/16"H. Unit has a 5"H x 12"W finished opening centered in the front panel for passage of books and a book chute to direct the books over a mobile depressible book truck. (Depressible book truck not included). Two 3" diameter grommets are located in the work surface.				

Please specify Wood Finish (Table 1), High-Pressure Laminate (Table 2), Metal Color (Table 3) and Resin Option (Table 6). Details can be found on pages GEN 4, GEN 5 and GEN 6.

**Circulation Desks with
Metal "T" Fronts, Single-Wide**

The Epoch Collection

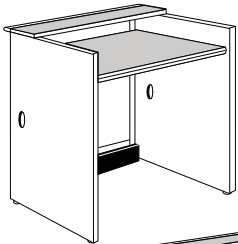
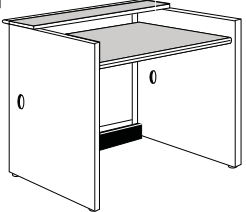
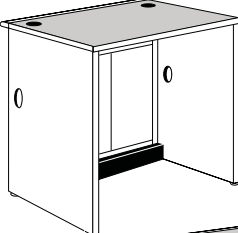
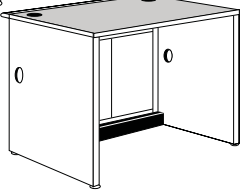
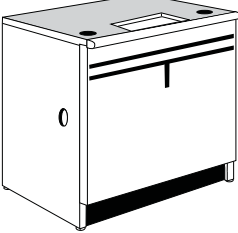
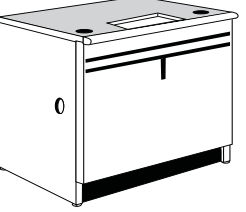
Oak Catalog No.	Maple Catalog No.	Description	H x W x D	Wt. (lbs.)	Oak Price	Maple Price	Standing	Sitting
59C-012-S02 OAK	59C-012-S02 MAP	Desk w/Painted Metal "T" Front	39-3/16" x 35" x 31-3/8"	140	\$3,232	\$3,523		Single-Wide Desk with Patron Service Ledge
59C-012-S00 OAK	59C-012-S00 MAP	Desk w/Chrome Metal "T" Front	39-3/16" x 35" x 31-3/8"	140	\$3,877	\$4,226		
		Inside dimensions: 33"W x 26-3/4"D. The 7-7/8" patron ledge is at a standing height of 39-3/16"H. Note: Adjustable-height work surface may be positioned at heights of 36", 32" or 27".						
59C-E12-S02 OAK	59C-E12-S02 MAP	Desk w/Painted Metal "T" Front	32-3/16" x 35" x 31-3/8"	125	\$2,980	\$3,249		
59C-E12-S00 OAK	59C-E12-S00 MAP	Desk w/Chrome Metal "T" Front	32-3/16" x 35" x 31-3/8"	125	\$3,577	\$3,898		
		Inside dimensions: 33"W x 26-3/4"D. The 7-7/8" patron ledge is at a sitting height of 32-3/16"H. Note: Work surface is fixed at 27"H.						
59C-014-S02 OAK	59C-014-S02 MAP	Desk w/Painted Metal "T" Front	39-3/16" x 35" x 31-3/8"	135	\$3,106	\$3,385		Single-Wide Desk without Patron Service Ledge
59C-014-S00 OAK	59C-014-S00 MAP	Desk w/Chrome Metal "T" Front	39-3/16" x 35" x 31-3/8"	135	\$3,727	\$4,062		
		Inside dimensions: 33"W x 26-3/4"D. The work surface is at a standing height of 39-3/16"H. Two 3" diameter grommets are located in the work surface.						
59C-E14-S02 OAK	59C-E14-S02 MAP	Desk w/Painted Metal "T" Front	32-3/16" x 35" x 31-3/8"	120	\$2,939	\$3,203		
59C-E14-S00 OAK	59C-E14-S00 MAP	Desk w/Chrome Metal "T" Front	32-3/16" x 35" x 31-3/8"	120	\$3,527	\$3,844		
		Inside dimensions: 33"W x 26-3/4"D. The work surface is at a sitting height of 32-3/16"H. Two 3" diameter grommets are located in the work surface.						
59C-015-S02 OAK	59C-015-S02 MAP	Desk w/Painted Metal "T" Front	39-3/16" x 35" x 31-3/8"	135	\$3,631	\$3,958		Book Return Unit
59C-015-S00 OAK	59C-015-S00 MAP	Desk w/Chrome Metal "T" Front	39-3/16" x 35" x 31-3/8"	135	\$4,357	\$4,749		
		Inside dimensions: 33"W x 26-3/4"D. The work surface is at a standing height 39-3/16"H. Unit has a 5"H x 12"W finished opening centered in the front panel for passage of books and a book chute to direct the books over a mobile depressible book truck. (Depressible book truck not included). Two 3" diameter grommets are located in the work surface.						
59C-E15-S02 OAK	59C-E15-S02 MAP	Desk w/Painted Metal "T" Front	32-3/16" x 35" x 31-3/8"	120	\$3,414	\$3,722		
59C-E15-S00 OAK	59C-E15-S00 MAP	Desk w/Chrome Metal "T" Front	32-3/16" x 35" x 31-3/8"	120	\$4,099	\$4,468		
		Inside dimensions: 33"W x 26-3/4"D. The work surface is at a sitting height 32-3/16"H. Unit has a 5"H x 12"W finished opening centered in the front panel for passage of books and a book chute to direct the books over a mobile depressible book truck. (Depressible book truck not included). Two 3" diameter grommets are located in the work surface.						

Please specify Wood Finish (Table 1), High-Pressure Laminate (Table 2) and Metal Color (Table 3). Details can be found on pages GEN 4 and GEN 5.

The Epoch Collection

Circulation Desks with Offset Resin Panel Fronts, Single-Wide

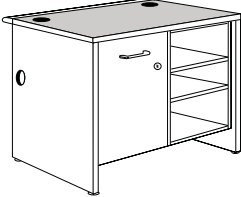
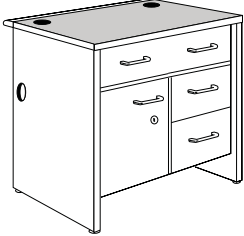
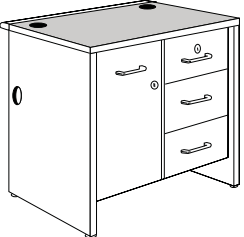
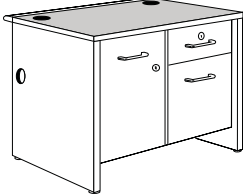
Standing	Sitting	Oak Catalog No.	Maple Catalog No.	Description	H x W x D	Wt. (lbs.)	Oak Price	Maple Price
Cupboard and Open Shelf		59-121-S02 OAK	59-121-S02 MAP	Desk w/Painted Resin Panel Front	39-3/16" x 35" x 31-3/8"	175	\$4,975	\$5,422
		59-121-S00 OAK	59-121-S00 MAP	Desk w/Chrome Resin Panel Front	39-3/16" x 35" x 31-3/8"	175	\$5,371	\$5,854
		This standing height unit has one fixed and two adjustable shelves. A hidden drawer is positioned above the lockable storage compartment. Two 3" diameter grommets are located in the work surface.						
		59-E21-S02 OAK	59-E21-S02 MAP	Desk w/Painted Resin Panel Front	32-3/16" x 35" x 31-3/8"	160	\$4,453	\$4,854
		59-E21-S00 OAK	59-E21-S00 MAP	Desk w/Chrome Resin Panel Front	32-3/16" x 35" x 31-3/8"	160	\$4,809	\$5,241
		This sitting height unit has one fixed and one adjustable shelf. A hidden drawer is positioned above the lockable storage compartment. Two 3" diameter grommets are located in the work surface.						
Full Width Drawer, Cupboard and Drawers		59-122-S02 OAK	59-122-S02 MAP	Desk w/Painted Resin Panel Front	39-3/16" x 35" x 31-3/8"	225	\$7,098	\$7,737
		59-122-S00 OAK	59-122-S00 MAP	Desk w/Chrome Resin Panel Front	39-3/16" x 35" x 31-3/8"	225	\$7,664	\$8,353
		This standing height unit has one full-width drawer, two file drawers, and a lockable storage compartment. Two 3" diameter grommets are located in the work surface. Note: Available in 39-3/16" H only.						
Cupboard and Drawer Unit		59-123-S02 OAK	59-123-S02 MAP	Desk w/Painted Resin Panel Front	39-3/16" x 35" x 31-3/8"	225	\$6,285	\$6,851
		59-123-S00 OAK	59-123-S00 MAP	Desk w/Chrome Resin Panel Front	39-3/16" x 35" x 31-3/8"	225	\$6,787	\$7,398
		This standing height unit has one locking box drawer and two file drawers. Cupboard section has two adjustable shelves and locking door on hinges. Two 3" diameter grommets are located in the work surface.						
		59-E23-S02 OAK	59-E23-S02 MAP	Desk w/Painted Resin Panel Front	32-3/16" x 35" x 31-3/8"	205	\$5,454	\$5,945
		59-E23-S00 OAK	59-E23-S00 MAP	Desk w/Chrome Resin Panel Front	32-3/16" x 35" x 31-3/8"	205	\$5,891	\$6,421
		This sitting height unit has one locking file drawer and one file drawer. Cupboard section has one adjustable shelf and locking door on hinges. Two 3" diameter grommets are located in the work surface.						

Please specify Wood Finish (Table 1), High-Pressure Laminate (Table 2), Metal Color (Table 3) and Resin Option (Table 6). Details can be found on pages GEN 4, GEN 5 and GEN 6.

**Circulation Desks with
Metal "T" Fronts, Single-Wide**

The Epoch Collection

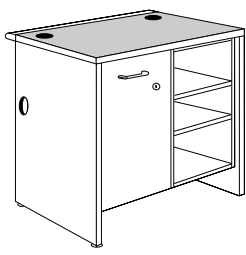
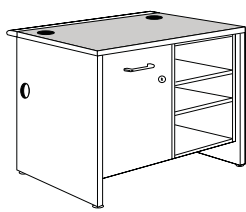
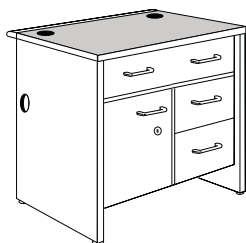
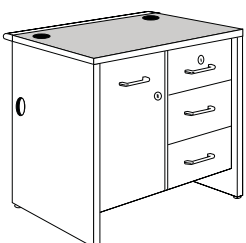
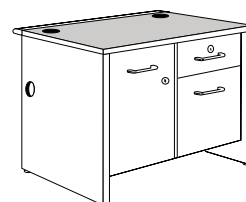
Oak Catalog No.	Maple Catalog No.	Description	H x W x D	Wt. (lbs.)	Oak Price	Maple Price	Standing	Sitting
59C-121-S02 OAK	59C-121-S02 MAP	Desk w/Painted Metal "T" Front	39-3/16" x 35" x 31-3/8"	175	\$4,661	\$5,080	Cupboard and Open Shelf	
59C-121-S00 OAK	59C-121-S00 MAP	Desk w/Chrome Metal "T" Front	39-3/16" x 35" x 31-3/8"	175	\$5,593	\$6,096		
		This standing height unit has one fixed and two adjustable shelves. A hidden drawer is positioned above the lockable storage compartment. Two 3" diameter grommets are located in the work surface.						
59C-E21-S02 OAK	59C-E21-S02 MAP	Desk w/Painted Metal "T" Front	32-3/16" x 35" x 31-3/8"	160	\$4,141	\$4,513		
59C-E21-S00 OAK	59C-E21-S00 MAP	Desk w/Chrome Metal "T" Front	32-3/16" x 35" x 31-3/8"	160	\$4,968	\$5,415		
		This sitting height unit has one fixed and one adjustable shelf. A hidden drawer is positioned above the lockable storage compartment. Two 3" diameter grommets are located in the work surface.						
59C-122-S02 OAK	59C-122-S02 MAP	Desk w/Painted Metal "T" Front	39-3/16" x 35" x 31-3/8"	225	\$6,740	\$7,347	Full Width Drawer, Cupboard and Drawers	
59C-122-S00 OAK	59C-122-S00 MAP	Desk w/Chrome Metal "T" Front	39-3/16" x 35" x 31-3/8"	225	\$8,091	\$8,819		
		This standing height unit has one full-width drawer, two file drawers, and a lockable storage compartment. Two 3" diameter grommets are located in the work surface. Note: Available in 39-3/16"H only.						
59C-123-S02 OAK	59C-123-S02 MAP	Desk w/Painted Metal "T" Front	39-3/16" x 35" x 31-3/8"	225	\$5,970	\$6,507	Cupboard and Drawer Unit	
59C-123-S00 OAK	59C-123-S00 MAP	Desk w/Chrome Metal "T" Front	39-3/16" x 35" x 31-3/8"	225	\$7,165	\$7,810		
		This standing height unit has one locking box drawer and two file drawers. Cupboard section has two adjustable shelves and locking door on hinges. Two 3" diameter grommets are located in the work surface.						
59C-E23-S02 OAK	59C-E23-S02 MAP	Desk w/Painted Metal "T" Front	32-3/16" x 35" x 31-3/8"	205	\$5,141	\$5,603		
59C-E23-S00 OAK	59C-E23-S00 MAP	Desk w/Chrome Metal "T" Front	32-3/16" x 35" x 31-3/8"	205	\$6,169	\$6,724		
		This sitting height unit has one locking file drawer and one file drawer. Cupboard section has one adjustable shelf and locking door on hinges. Two 3" diameter grommets are located in the work surface.						

Please specify Wood Finish (Table 1), High-Pressure Laminate (Table 2) and Metal Color (Table 3). Details can be found on pages GEN 4 and GEN 5.

The Epoch Collection

Circulation Desks with Offset Resin Panel Fronts, Single-Wide

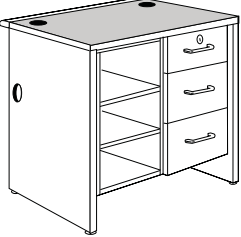
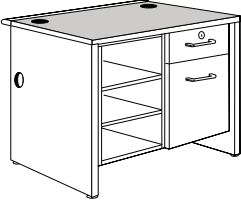
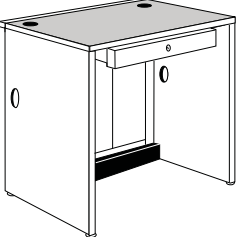
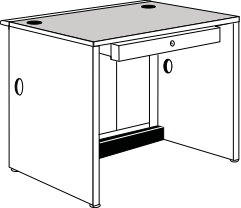
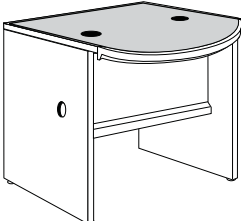
Standing	Sitting	Oak Catalog No.	Maple Catalog No.	Description	H x W x D	Wt. (lbs.)	Oak Price	Maple Price
Open Shelf and Drawer Unit		59-124-S02 OAK	59-124-S02 MAP	Desk w/Painted Resin Panel Front	39-3/16" x 35" x 31-3/8"	200	\$5,711	\$6,225
		59-124-S00 OAK	59-124-S00 MAP	Desk w/Chrome Resin Panel Front	39-3/16" x 35" x 31-3/8"	200	\$6,168	\$6,723
				This standing height unit has one lockable box drawer and two file drawers. Shelf section has two adjustable shelves, and one fixed base shelf. Two 3" diameter grommets are located in the work surface.				
		59-E24-S02 OAK	59-E24-S02 MAP	Desk w/Painted Resin Panel Front	32-3/16" x 35" x 31-3/8"	180	\$5,041	\$5,494
		59-E24-S00 OAK	59-E24-S00 MAP	Desk w/Chrome Resin Panel Front	32-3/16" x 35" x 31-3/8"	180	\$5,444	\$5,934
				This sitting height unit has one lockable box drawer and one file drawer. Shelf section has one adjustable shelf, and one fixed base shelf. Two 3" diameter grommets are located in the work surface.				
Cash Drawer Unit		59-131-S02 OAK	59-131-S02 MAP	Desk w/Painted Resin Panel Front	39-3/16" x 35" x 31-3/8"	150	\$3,844	\$4,189
		59-131-S00 OAK	59-131-S00 MAP	Desk w/Chrome Resin Panel Front	39-3/16" x 35" x 31-3/8"	150	\$4,150	\$4,524
				Inside dimensions: 33"W x 26-3/4"D. The work surface is at a standing height 39-3/16"H. Desk has locking drawer with a coin and currency tray. Two 3" diameter grommets are located in the work surface.				
		59-E31-S02 OAK	59-E31-S02 MAP	Desk w/Painted Resin Panel Front	32-3/16" x 35" x 31-3/8"	135	\$3,652	\$3,981
		59-E31-S00 OAK	59-E31-S00 MAP	Desk w/Chrome Resin Panel Front	32-3/16" x 35" x 31-3/8"	135	\$3,945	\$4,301
				Inside dimensions: 33"W x 26-3/4"D. The work surface is at a sitting height 32-3/16"H. Desk has locking drawer with a coin and currency tray. Two 3" diameter grommets are located in the work surface.				
ADA Station		59-E32-S00 OAK	59-E32-S00 MAP	Desk w/Chrome Resin Panel Front	32-3/16" x 35" x 42-1/8"	185	\$2,771	\$3,020
				The sitting height ADA transaction station is designed to provide wheelchair access on the patrons' side. The knee space depth on the patrons' side is 22-1/4" and on the staff side is 16". Two 3" diameter grommets are located in the work surface. One 3-1/2" diameter egress with sleeve is located in each end panel for wire passage. Note: Available in 32-3/16"H only.				

Please specify Wood Finish (Table 1), High-Pressure Laminate (Table 2), Metal Color (Table 3) and Resin Option (Table 6). Details can be found on pages GEN 4, GEN 5 and GEN 6.

**Circulation Desks with
Metal "T" Fronts, Single-Wide**

The Epoch Collection

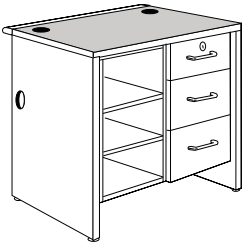
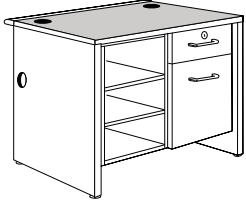
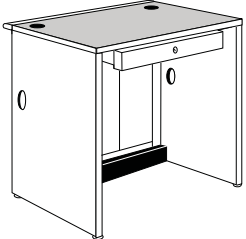
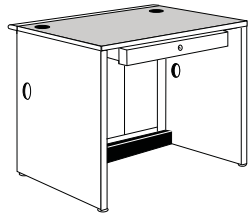
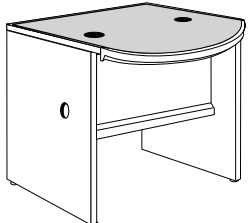
Oak Catalog No.	Maple Catalog No.	Description	H x W x D	Wt. (lbs.)	Oak Price	Maple Price	Standing	Sitting
59C-124-S02 OAK	59C-124-S02 MAP	Desk w/Painted Metal "T" Front	39-3/16" x 35" x 31-3/8"	200	\$5,398	\$5,884	Open Shelf and Drawer Unit	
59C-124-S00 OAK	59C-124-S00 MAP	Desk w/Chrome Metal "T" Front	39-3/16" x 35" x 31-3/8"	200	\$6,477	\$7,060		
		<p>This standing height unit has one lockable box drawer and two file drawers. Shelf section has two adjustable shelves, and one fixed base shelf. Two 3" diameter grommets are located in the work surface.</p>						
59C-E24-S02 OAK	59C-E24-S02 MAP	Desk w/Painted Metal "T" Front	32-3/16" x 35" x 31-3/8"	180	\$4,728	\$5,153		
59C-E24-S00 OAK	59C-E24-S00 MAP	Desk w/Chrome Metal "T" Front	32-3/16" x 35" x 31-3/8"	180	\$5,673	\$6,183		
		<p>This sitting height unit has one lockable box drawer and one file drawer. Shelf section has one adjustable shelf, and one fixed base shelf. Two 3" diameter grommets are located in the work surface.</p>						
59C-131-S02 OAK	59C-131-S02 MAP	Desk w/Painted Metal "T" Front	39-3/16" x 35" x 31-3/8"	150	\$3,530	\$3,848	Cash Drawer Unit	
59C-131-S00 OAK	59C-131-S00 MAP	Desk w/Chrome Metal "T" Front	39-3/16" x 35" x 31-3/8"	150	\$4,235	\$4,616		
		<p>Inside dimensions: 33"W x 26-3/4"D. The work surface is at a standing height 39-3/16"H. Desk has locking drawer with a coin and currency tray. Two 3" diameter grommets are located in the work surface.</p>						
59C-E31-S02 OAK	59C-E31-S02 MAP	Desk w/Painted Metal "T" Front	32-3/16" x 35" x 31-3/8"	135	\$3,340	\$3,640		
59C-E31-S00 OAK	59C-E31-S00 MAP	Desk w/Chrome Metal "T" Front	32-3/16" x 35" x 31-3/8"	135	\$4,009	\$4,369		
		<p>Inside dimensions: 33"W x 26-3/4"D. The work surface is at a sitting height 32-3/16"H. Desk has locking drawer with a coin and currency tray. Two 3" diameter grommets are located in the work surface.</p>						
59C-E32-S00 OAK	59C-E32-S00 MAP	Desk w/Chrome Metal "T" Front	32-3/16" x 35" x 42-1/8"	185	\$2,771	\$3,020	ADA Station	
		<p>The sitting height ADA transaction station is designed to provide wheelchair access on the patrons' side. The knee space depth on the patrons' side is 22-1/4" and on the staff side is 16". Two 3" diameter grommets are located in the work surface. One 3-1/2" diameter egress with sleeve is located in each end panel for wire passage. Note: Available in 32-3/16"H only.</p>						

Please specify Wood Finish (Table 1), High-Pressure Laminate (Table 2) and Metal Color (Table 3). Details can be found on pages GEN 4 and GEN 5.

The Epoch Collection

Circulation Desks with Offset Resin Panel Fronts, Single-Wide

Standing	Sitting	Oak Catalog No.	Maple Catalog No.	Description	H x W x D	Wt. (lbs.)	Oak Price	Maple Price
Full Width Drawer Unit		59-133-S02 OAK	59-133-S02 MAP	Desk w/Painted Resin Panel Front	39-3/16" x 35" x 31-3/8"	160	\$4,092	\$4,460
		59-133-S00 OAK	59-133-S00 MAP	Desk w/Chrome Resin Panel Front	39-3/16" x 35" x 31-3/8"	160	\$4,420	\$4,818

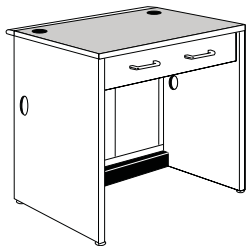

This standing height drawer unit has a full-width drawer 10"H x 32-7/8"W x 18-1/4"D. Two 3" diameter grommets are located in the work surface.
Note: Available in 39-3/16"H only.

Full Width Drawer and Cupboard Unit		59-135-S02 OAK	59-135-S02 MAP	Desk w/Painted Resin Panel Front	39-3/16" x 35" x 31-3/8"	220	\$5,199	\$5,667
		59-135-S00 OAK	59-135-S00 MAP	Desk w/Chrome Resin Panel Front	39-3/16" x 35" x 31-3/8"	220	\$5,615	\$6,121



This standing height unit has a full-width drawer 10"H x 32-7/8"W x 18-3/4"D. Also, one fixed and one adjustable, full-depth shelf. Hinged doors have a catch, lock and door pulls. Two 3" diameter grommets are located in the work surface.
Note: Available in 39-3/16"H only.

Discharge Unit		59-172-S02 OAK	59-172-S02 MAP	Desk w/Painted Resin Panel Front	39-3/16" x 35" x 31-3/8"	165	\$5,275	\$5,749
		59-172-S00 OAK	59-172-S00 MAP	Desk w/Chrome Resin Panel Front	39-3/16" x 35" x 31-3/8"	165	\$5,696	\$6,209

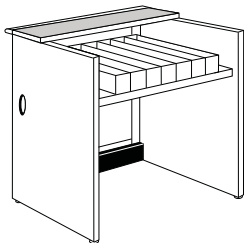

These standing height units have a full-width well with seven removable wood trays for 5"H x 3"W cards. The 7-7/8" patron ledge is at a height of 39-3/16"H.
Note: Standing-height roll unders do not work with this unit.

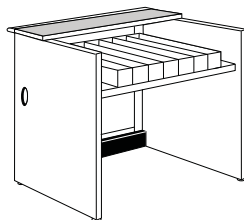

		59-E72-S02 OAK	59-E72-S02 MAP	Desk w/Painted Resin Panel Front	32-3/16" x 35" x 31-3/8"	145	\$5,028	\$5,480
		59-E72-S00 OAK	59-E72-S00 MAP	Desk w/Chrome Resin Panel Front	32-3/16" x 35" x 31-3/8"	145	\$5,431	\$5,920

These sitting height units have a full-width well with seven removable wood trays for 5"H x 3"W cards. The 7-7/8" patron ledge is at a height of 32-3/16"H.

Please specify Wood Finish (Table 1), High-Pressure Laminate (Table 2), Metal Color (Table 3) and Resin Option (Table 6). Details can be found on pages GEN 4, GEN 5 and GEN 6.

**Circulation Desks with
Metal "T" Fronts, Single-Wide**

The Epoch Collection

Oak Catalog No.	Maple Catalog No.	Description	H x W x D	Wt. (lbs.)	Oak Price	Maple Price	Standing	Sitting
59C-133-S02 OAK	59C-133-S02 MAP	Desk w/Painted Metal "T" Front	39-3/16" x 35" x 31-3/8"	160	\$3,778	\$4,119	Full Width Drawer Unit	
59C-133-S00 OAK	59C-133-S00 MAP	Desk w/Chrome Metal "T" Front	39-3/16" x 35" x 31-3/8"	160	\$4,533	\$4,941		

This standing height drawer unit has a full-width drawer 10"H x 32-7/8"W x 18-1/4"D. Two 3" diameter grommets are located in the work surface.
Note: Available in 39-3/16"H only.

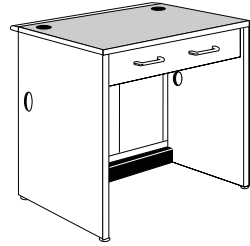

59C-135-S02 OAK	59C-135-S02 MAP	Desk w/Painted Metal "T" Front	39-3/16" x 35" x 31-3/8"	220	\$4,886	\$5,326	Full Width Drawer and Cupboard Unit	
59C-135-S00 OAK	59C-135-S00 MAP	Desk w/Chrome Metal "T" Front	39-3/16" x 35" x 31-3/8"	220	\$5,865	\$6,393		

This standing height unit has a full-width drawer 10"H x 32-7/8"W x 18-3/4"D. Also, one fixed and one adjustable, full-depth shelf. Hinged doors have a catch, lock and door pulls. Two 3" diameter grommets are located in the work surface.
Note: Available in 39-3/16"H only.

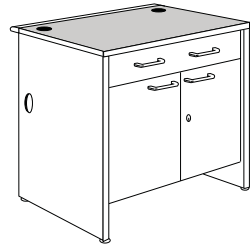

59C-172-S02 OAK	59C-172-S02 MAP	Desk w/Painted Metal "T" Front	39-3/16" x 35" x 31-3/8"	165	\$4,959	\$5,405	Discharge Unit	
59C-172-S00 OAK	59C-172-S00 MAP	Desk w/Chrome Metal "T" Front	39-3/16" x 35" x 31-3/8"	165	\$5,951	\$6,487		

These standing height units have a full-width well with seven removable wood trays for 5"H x 3"W cards. The 7-7/8" patron ledge is at a height of 39-3/16"H.
Note: Standing-height roll unders do not work with this unit.

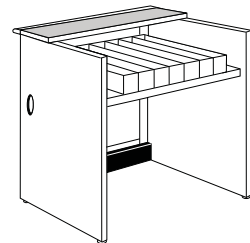

59C-E72-S02 OAK	59C-E72-S02 MAP	Desk w/Painted Metal "T" Front	32-3/16" x 35" x 31-3/8"	145	\$4,714	\$5,139	Discharge Unit	
59C-E72-S00 OAK	59C-E72-S00 MAP	Desk w/Chrome Metal "T" Front	32-3/16" x 35" x 31-3/8"	145	\$5,659	\$6,168		

These sitting height units have a full-width well with seven removable wood trays for 5"H x 3"W cards. The 7-7/8" patron ledge is at a height of 32-3/16"H.

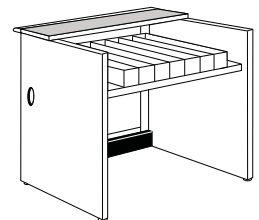

Please specify Wood Finish (Table 1), High-Pressure Laminate (Table 2) and Metal Color (Table 3). Details can be found on pages GEN 4 and GEN 5.

The Epoch Collection

Circulation Desks with Offset Resin Panel Fronts, Single-Wide

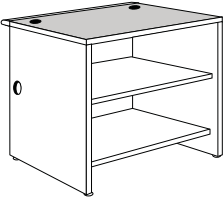
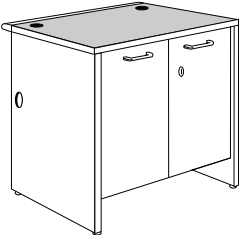
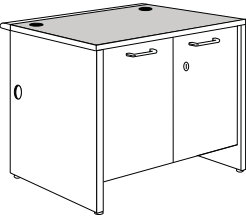
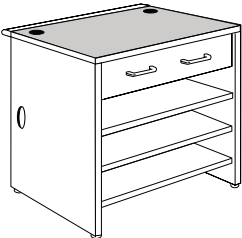
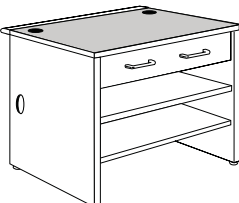
Standing	Sitting	Oak Catalog No.	Maple Catalog No.	Description	H x W x D	Wt. (lbs.)	Oak Price	Maple Price
Open Shelf Unit		59-174-S02 OAK	59-174-S02 MAP	Desk w/Painted Resin Panel Front	39-3/16" x 35" x 31-3/8"	175	\$4,130	\$4,502
		59-174-S00 OAK	59-174-S00 MAP	Desk w/Chrome Resin Panel Front	39-3/16" x 35" x 31-3/8"	175	\$4,460	\$4,861
				This standing height unit has a full-depth fixed base shelf and two full-depth adjustable shelves. Two 3" diameter grommets are located in the work surface.				
	Open Shelf Unit	59-E74-S02 OAK	59-E74-S02 MAP	Desk w/Painted Resin Panel Front	32-3/16" x 35" x 31-3/8"	155	\$3,767	\$4,106
		59-E74-S00 OAK	59-E74-S00 MAP	Desk w/Chrome Resin Panel Front	32-3/16" x 35" x 31-3/8"	155	\$4,069	\$4,435
				This sitting height unit has a full-depth fixed base shelf and two full-depth adjustable shelves. Two 3" diameter grommets are located in the work surface.				
Cupboard Unit		59-176-S02 OAK	59-176-S02 MAP	Desk w/Painted Resin Panel Front	39-3/16" x 35" x 31-3/8"	200	\$4,812	\$5,246
		59-176-S00 OAK	59-176-S00 MAP	Desk w/Chrome Resin Panel Front	39-3/16" x 35" x 31-3/8"	200	\$5,198	\$5,665
				This standing height unit has a full-depth fixed base shelf and two full-depth adjustable shelves. Hinged doors have a catch, lock and door pulls. Two 3" diameter grommets are located in the work surface.				
	Cupboard Unit	59-E76-S02 OAK	59-E76-S02 MAP	Desk w/Painted Resin Panel Front	32-3/16" x 35" x 31-3/8"	180	\$4,431	\$4,830
		59-E76-S00 OAK	59-E76-S00 MAP	Desk w/Chrome Resin Panel Front	32-3/16" x 35" x 31-3/8"	180	\$4,785	\$5,216
				This sitting height unit has a full-depth fixed base shelf and one full-depth adjustable shelf. Hinged doors have a catch, lock and door pulls. Two 3" diameter grommets are located in the work surface.				
Full Width Drawer and Open Shelves		59-234-S02 OAK	59-234-S02 MAP	Desk w/Painted Resin Panel Front	39-3/16" x 35" x 31-3/8"	180	\$4,668	\$5,088
		59-234-S00 OAK	59-234-S00 MAP	Desk w/Chrome Resin Panel Front	39-3/16" x 35" x 31-3/8"	180	\$5,042	\$5,495
				This standing height unit has a full-width drawer 10"H x 32-7/8"W x 18-3/4"D. Also, one fixed and one adjustable, full-depth shelf. Two 3" diameter grommets are located in the work surface.				
	Full Width Drawer and Open Shelves	59-E34-S02 OAK	59-E34-S02 MAP	Desk w/Painted Resin Panel Front	32-3/16" x 35" x 31-3/8"	165	\$4,342	\$4,732
		59-E34-S00 OAK	59-E34-S00 MAP	Desk w/Chrome Resin Panel Front	32-3/16" x 35" x 31-3/8"	165	\$4,691	\$5,113
				This sitting height unit has a full-width drawer 10"H x 32-7/8"W x 18-3/4"D. Also, one fixed and one adjustable, full-depth shelf. Two 3" diameter grommets are located in the work surface.				

Please specify Wood Finish (Table 1), High-Pressure Laminate (Table 2), Metal Color (Table 3) and Resin Option (Table 6). Details can be found on pages GEN 4, GEN 5 and GEN 6.

**Circulation Desks with
Metal "T" Fronts, Single-Wide**

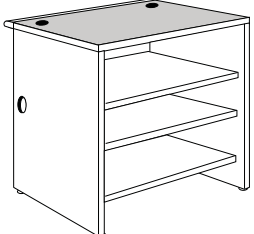
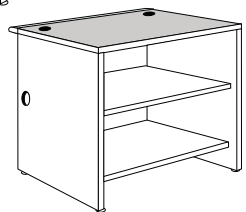
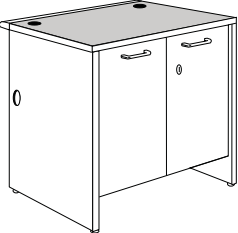
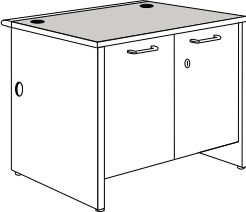
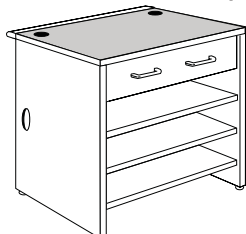
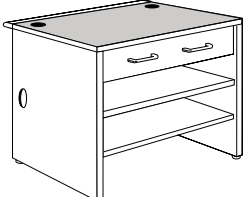

The Epoch Collection

Oak Catalog No.	Maple Catalog No.	Description	H x W x D	Wt. (lbs.)	Oak Price	Maple Price	Standing	Sitting
59C-174-S02 OAK	59C-174-S02 MAP	Desk w/Painted Metal "T" Front	39-3/16" x 35" x 31-3/8"	175	\$3,818	\$4,162		Open Shelf Unit
59C-174-S00 OAK	59C-174-S00 MAP	Desk w/Chrome Metal "T" Front	39-3/16" x 35" x 31-3/8"	175	\$4,580	\$4,993		
		<p>This standing height unit has a full-depth fixed base shelf and two full-depth adjustable shelves. Two 3" diameter grommets are located in the work surface.</p>						
59C-E74-S02 OAK	59C-E74-S02 MAP	Desk w/Painted Metal "T" Front	32-3/16" x 35" x 31-3/8"	155	\$3,454	\$3,765		
59C-E74-S00 OAK	59C-E74-S00 MAP	Desk w/Chrome Metal "T" Front	32-3/16" x 35" x 31-3/8"	155	\$4,143	\$4,516		
		<p>This sitting height unit has a full-depth fixed base shelf and two full-depth adjustable shelves. Two 3" diameter grommets are located in the work surface.</p>						
59C-176-S02 OAK	59C-176-S02 MAP	Desk w/Painted Metal "T" Front	39-3/16" x 35" x 31-3/8"	200	\$4,501	\$4,905		Cupboard Unit
59C-176-S00 OAK	59C-176-S00 MAP	Desk w/Chrome Metal "T" Front	39-3/16" x 35" x 31-3/8"	200	\$5,399	\$5,885		
		<p>This standing height unit has a full-depth fixed base shelf and two full-depth adjustable shelves. Hinged doors have a catch, lock and door pulls. Two 3" diameter grommets are located in the work surface.</p>						
59C-E76-S02 OAK	59C-E76-S02 MAP	Desk w/Painted Metal "T" Front	32-3/16" x 35" x 31-3/8"	180	\$4,118	\$4,489		
59C-E76-S00 OAK	59C-E76-S00 MAP	Desk w/Chrome Metal "T" Front	32-3/16" x 35" x 31-3/8"	180	\$4,942	\$5,387		
		<p>This sitting height unit has a full-depth fixed base shelf and one full-depth adjustable shelf. Hinged doors have a catch, lock and door pulls. Two 3" diameter grommets are located in the work surface.</p>						
59C-234-S02 OAK	59C-234-S02 MAP	Desk w/Painted Metal "T" Front	39-3/16" x 35" x 31-3/8"	180	\$4,356	\$4,748		Full Width Drawer and Open Shelves
59C-234-S00 OAK	59C-234-S00 MAP	Desk w/Chrome Metal "T" Front	39-3/16" x 35" x 31-3/8"	180	\$5,226	\$5,696		
		<p>This standing height unit has a full-width drawer 10"H x 32-7/8"W x 18-3/4"D. Also, one fixed and one adjustable, full-depth shelf. Two 3" diameter grommets are located in the work surface.</p>						
59C-E34-S02 OAK	59C-E34-S02 MAP	Desk w/Painted Metal "T" Front	32-3/16" x 35" x 31-3/8"	165	\$4,030	\$4,393		
59C-E34-S00 OAK	59C-E34-S00 MAP	Desk w/Chrome Metal "T" Front	32-3/16" x 35" x 31-3/8"	165	\$4,837	\$5,272		
		<p>This sitting height unit has a full-width drawer 10"H x 32-7/8"W x 18-3/4"D. Also, one fixed and one adjustable, full-depth shelf. Two 3" diameter grommets are located in the work surface.</p>						

Please specify Wood Finish (Table 1), High-Pressure Laminate (Table 2) and Metal Color (Table 3). Details can be found on pages GEN 4 and GEN 5.

The Epoch Collection



Circulation Desks with Offset Resin Panel Fronts, Single-Wide

Standing	Sitting	Oak Catalog No.	Maple Catalog No.	Description	H x W x D	Wt. (lbs.)	Oak Price	Maple Price
Media Storage Unit		59-236-S02 OAK	59-236-S02 MAP	Desk w/Painted Resin Panel Front	39-3/16" x 35" x 31-3/8"	225	\$6,485	\$7,069
		59-236-S00 OAK	59-236-S00 MAP	Desk w/Chrome Resin Panel Front	39-3/16" x 35" x 31-3/8"	225	\$7,004	\$7,634
		This standing height unit has four full-width drawers 8-1/2"H x 33"W x 24"D with each containing five compartments for media storage.						
		59-E36-S02 OAK	59-E36-S02 MAP	Desk w/Painted Resin Panel Front	32-3/16" x 35" x 31-3/8"	205	\$6,034	\$6,577
		59-E36-S00 OAK	59-E36-S00 MAP	Desk w/Chrome Resin Panel Front	32-3/16" x 35" x 31-3/8"	205	\$6,517	\$7,104
		This sitting height unit has three full-width drawers 8-1/2"H x 33"W x 24"D with each containing five compartments for media storage.						

Please specify Wood Finish (Table 1), High-Pressure Laminate (Table 2), Metal Color (Table 3) and Resin Option (Table 6). Details can be found on pages GEN 4, GEN 5 and GEN 6.

**Circulation Desks with
Metal "T" Fronts, Single-Wide**

The Epoch Collection

Oak Catalog No.	Maple Catalog No.	Description	H x W x D	Wt. (lbs.)	Oak Price	Maple Price	Standing	Sitting
59C-236-S02 OAK	59C-236-S02 MAP	Desk w/Painted Metal "T" Front	39-3/16" x 35" x 31-3/8"	225	\$6,051	\$6,596		Media Storage Unit
59C-236-S00 OAK	59C-236-S00 MAP	Desk w/Chrome Metal "T" Front	39-3/16" x 35" x 31-3/8"	225	\$7,260	\$7,913		
		This standing height unit has four full-width drawers 8-1/2"H x 33"W x 24"D with each containing five compartments for media storage.						
59C-E36-S02 OAK	59C-E36-S02 MAP	Desk w/Painted Metal "T" Front	32-3/16" x 35" x 31-3/8"	205	\$5,599	\$6,103		
59C-E36-S00 OAK	59C-E36-S00 MAP	Desk w/Chrome Metal "T" Front	32-3/16" x 35" x 31-3/8"	205	\$6,719	\$7,324		
		This sitting height unit has three full-width drawers 8-1/2"H x 33"W x 24"D with each containing five compartments for media storage.						

Please specify Wood Finish (Table 1), High-Pressure Laminate (Table 2) and Metal Color (Table 3). Details can be found on pages GEN 4 and GEN 5.

The Epoch Collection

Circulation Desks with Offset Resin Panel Fronts, Double-Wide

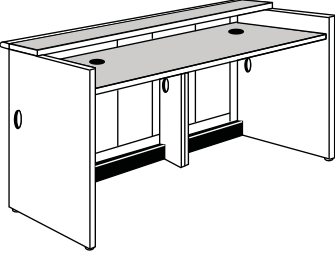
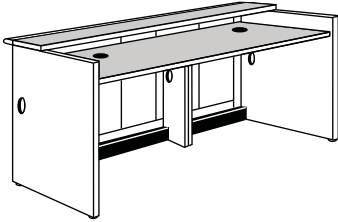
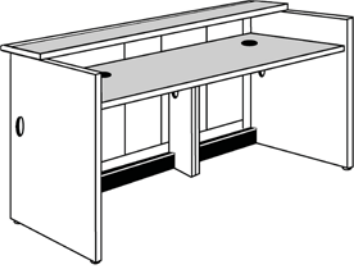
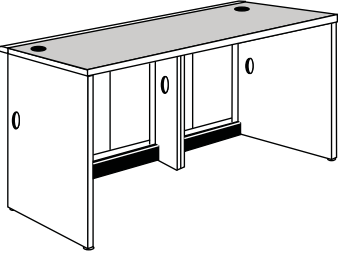
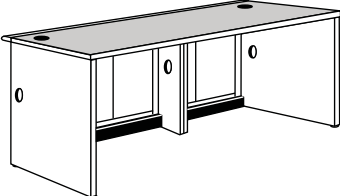
Standing	Sitting	Oak Catalog No.	Maple Catalog No.	Description	H x W x D	Wt. (lbs.)	Oak Price	Maple Price
Double-Wide Desk with Patron Service Ledge, 		59-011-S02 OAK	59-011-S02 MAP	Desk w/Painted Resin Panel Front	39-3/16" x 70" x 31-3/8"	245	\$6,120	\$6,671
		59-011-S00 OAK	59-011-S00 MAP	Desk w/Chrome Resin Panel Front	39-3/16" x 70" x 31-3/8"	245	\$6,609	\$7,204
				Work Surface at 35-1/2"H Inside dimensions are 68"W x 26-3/4"D. The 7-7/8"D patron ledge is at a standing height of 39-3/16". Two 3" diameter grommets are located in the work surface. Note: Standing-height roll unders do not work with this unit.				
		59-E11-S02 OAK	59-E11-S02 MAP	Desk w/Painted Resin Panel Front	32-3/16" x 70" x 31-3/8"	210	\$5,747	\$6,265
		59-E11-S00 OAK	59-E11-S00 MAP	Desk w/Chrome Resin Panel Front	32-3/16" x 70" x 31-3/8"	210	\$6,206	\$6,765
				Desk with Patron Service Ledge Work Surface at 28-1/2"H Inside dimensions are 68"W x 26-3/4"D. The 7-7/8"D patron ledge is at a sitting height of 32-3/16". Two 3" diameter grommets are located in the work surface.				
		59-011-SE2 OAK	59-011-SE2 MAP	Desk w/Painted Resin Panel Front	39-3/16" x 70" x 31-3/8"	245	\$6,132	\$6,684
		59-011-SEA OAK	59-011-SEA MAP	Desk w/Chrome Resin Panel Front	39-3/16" x 70" x 31-3/8"	245	\$6,623	\$7,219
				Desk with Patron Service Ledge Work Surface at 28-1/2"H Inside dimensions are 68"W x 26-3/4"D. The 7-7/8"D patron ledge is at a standing height of 39-3/16". Two 3" diameter grommets are located in the work surface. Note: Standing-height roll unders do not work with this unit.				
Double-Wide Desk without Patron Service Ledge 		59-013-S02 OAK	59-013-S02 MAP	Desk w/Painted Resin Panel Front	39-3/16" x 70" x 31-3/8"	230	\$6,015	\$6,557
		59-013-S00 OAK	59-013-S00 MAP	Desk w/Chrome Resin Panel Front	39-3/16" x 70" x 31-3/8"	230	\$6,498	\$7,083
				Inside dimensions are 68"W x 26-3/4"D. The work surface is at 39-3/16" H. Two 3" diameter grommets are located in the work surface.				
		59-E13-S02 OAK	59-E13-S02 MAP	Desk w/Painted Resin Panel Front	32-3/16" x 70" x 31-3/8"	195	\$5,726	\$6,241
		59-E13-S00 OAK	59-E13-S00 MAP	Desk w/Chrome Resin Panel Front	32-3/16" x 70" x 31-3/8"	195	\$6,184	\$6,741
				Inside dimensions are 68"W x 26-3/4"D. The work surface is at 32-3/16" H. Two 3" diameter grommets are located in the work surface.				

Please specify Wood Finish (Table 1), High-Pressure Laminate (Table 2), Metal Color (Table 3) and Resin Option (Table 6). Details can be found on pages GEN 4, GEN 5 and GEN 6.

**Circulation Desks with
Metal "T" Fronts, Double-Wide**

The Epoch Collection

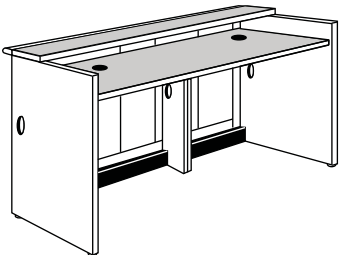
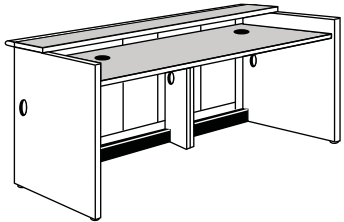
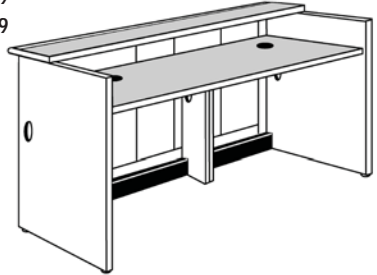
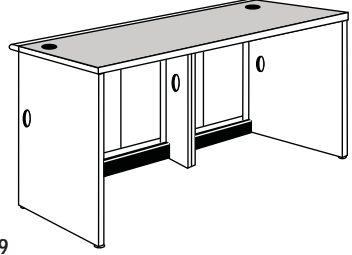
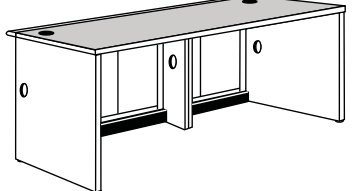
Oak Catalog No.	Maple Catalog No.	Description	H x W x D	Wt. (lbs.)	Oak Price	Maple Price	Standing	Sitting
59C-011-S02 OAK	59C-011-S02 MAP	Desk w/Painted Metal "T" Front	39-3/16" x 70" x 31-3/8"	245	\$5,494	\$5,988	Double-Wide Desk with Patron Service Ledge,	
59C-011-S00 OAK	59C-011-S00 MAP	Desk w/Chrome Metal "T" Front	39-3/16" x 70" x 31-3/8"	245	\$6,593	\$7,186		
<p>Work Surface at 35-1/2"H Inside dimensions are 68"W x 26-3/4"D. The 7-7/8"D patron ledge is at a standing height of 39-3/16". Two 3" diameter grommets are located in the work surface. Note: Standing-height roll unders do not work with this unit.</p>								
								
59C-E11-S02 OAK	59C-E11-S02 MAP	Desk w/Painted Metal "T" Front	32-3/16" x 70" x 31-3/8"	210	\$5,121	\$5,582		
59C-E11-S00 OAK	59C-E11-S00 MAP	Desk w/Chrome Metal "T" Front	32-3/16" x 70" x 31-3/8"	210	\$6,145	\$6,698		
<p>Desk with Patron Service Ledge Work Surface at 28-1/2"H Inside dimensions are 68"W x 26-3/4"D. The 7-7/8"D patron ledge is at a sitting height of 32-3/16". Two 3" diameter grommets are located in the work surface.</p>								
								
59C-011-SE2 OAK	59C-011-SE2 MAP	Desk w/Painted Metal "T" Front	39-3/16" x 70" x 31-3/8"	245	\$5,504	\$5,999		
59C-011-SEA OAK	59C-011-SEA MAP	Desk w/Chrome Metal "T" Front	39-3/16" x 70" x 31-3/8"	245	\$6,605	\$7,199		
<p>Desk with Patron Service Ledge Work Surface at 28-1/2"H Inside dimensions are 68"W x 26-3/4"D. The 7-7/8"D patron ledge is at a standing height of 39-3/16". Two 3" diameter grommets are located in the work surface. Note: Standing-height roll unders do not work with this unit.</p>								
								
59C-013-S02 OAK	59C-013-S02 MAP	Desk w/Painted Metal "T" Front	39-3/16" x 70" x 31-3/8"	230	\$5,391	\$5,876	Double-Wide Desk without Patron Service Ledge	
59C-013-S00 OAK	59C-013-S00 MAP	Desk w/Chrome Metal "T" Front	39-3/16" x 70" x 31-3/8"	230	\$6,470	\$7,052		
<p>Inside dimensions are 68"W x 26-3/4"D. The work surface is at 39-3/16" H. Two 3" diameter grommets are located in the work surface.</p>								
								
59C-E13-S02 OAK	59C-E13-S02 MAP	Desk w/Painted Metal "T" Front	32-3/16" x 70" x 31-3/8"	195	\$5,101	\$5,559		
59C-E13-S00 OAK	59C-E13-S00 MAP	Desk w/Chrome Metal "T" Front	32-3/16" x 70" x 31-3/8"	195	\$6,119	\$6,670		
<p>Inside dimensions are 68"W x 26-3/4"D. The work surface is at 32-3/16" H. Two 3" diameter grommets are located in the work surface.</p>								
								

Please specify Wood Finish (Table 1), High-Pressure Laminate (Table 2) and Metal Color (Table 3). Details can be found on pages GEN 4 and GEN 5.

The Epoch Collection

Circulation Desks with Offset Resin Panel Fronts, Double-Wide

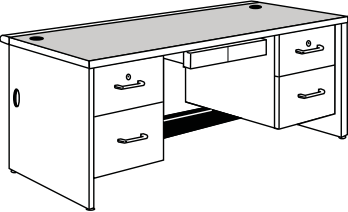
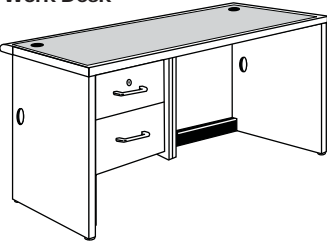
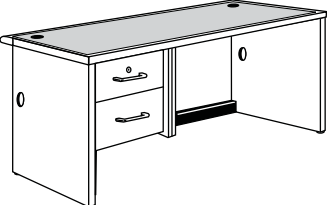
Standing	Sitting	Oak Catalog No.	Maple Catalog No.	Description	H x W x D	Wt. (lbs.)	Oak Price	Maple Price
Double-Wide Double Pedestal Work Desk		59-E37-S02 OAK	59-E37-S02 MAP	Desk w/Painted Resin Panel Front	32-3/16" x 70" x 31-3/8"	260	\$9,163	\$9,987
		59-E37-S00 OAK	59-E37-S00 MAP	Desk w/Chrome Resin Panel Front	32-3/16" x 70" x 31-3/8"	260	\$9,896	\$10,786
				<p>Inside dimensions are 68"W x 26-3/4"D.</p> <p>This sitting height unit has two drawer pedestals, one mounted on each side consisting of one locking drawer at top; one file drawer with hanging file rack at bottom.</p> <p>Two center drawers are mounted between the two pedestals.</p> <p>Two 3" diameter grommets are located in the work surface.</p> <p>Note: Available in 32-3/16" H only.</p>				
Double-Wide Single Pedestal Work Desk		59-238-S02 OAK	59-238-S02 MAP	Desk w/Painted Resin Panel Front	39-3/16" x 70" x 31-3/8"	230	\$8,184	\$8,921
		59-238-S00 OAK	59-238-S00 MAP	Desk w/Chrome Resin Panel Front	39-3/16" x 70" x 31-3/8"	230	\$8,838	\$9,634
				<p>Inside dimensions are 68"W x 26-3/4"D.</p> <p>This standing height unit has one drawer pedestal mounted on the left side consisting of one locking drawer at top; two file drawers with Pendaflex hangers at the bottom. Two 3" diameter grommets are located in the work surface.</p>				
	59-E38-S02 OAK	59-E38-S02 MAP	Desk w/Painted Resin Panel Front	32-3/16" x 70" x 31-3/8"	195	\$7,614	\$8,299	
	59-E38-S00 OAK	59-E38-S00 MAP	Desk w/Chrome Resin Panel Front	32-3/16" x 70" x 31-3/8"	195	\$8,225	\$8,965	
				<p>Inside dimensions are 68"W x 26-3/4"D.</p> <p>This sitting height unit has one drawer pedestal mounted on the left side consisting of one locking file drawer at top; one file drawer at the bottom, both with hanging file racks. Two 3" diameter grommets are located in the work surface.</p>				

Please specify Wood Finish (Table 1), High-Pressure Laminate (Table 2), Metal Color (Table 3) and Resin Option (Table 6). Details can be found on pages GEN 4, GEN 5 and GEN 6.

**Circulation Desks with
Metal "T" Fronts, Double-Wide**

The Epoch Collection

Oak Catalog No.	Maple Catalog No.	Description	H x W x D	Wt. (lbs.)	Oak Price	Maple Price	Standing	Sitting
59C-E37-S02 OAK	59C-E37-S02 MAP	Desk w/Painted Metal "T" Front	32-3/16" x 70" x 31-3/8"	260	\$8,855	\$9,652	Double-Wide	Double Pedestal Work Desk
59C-E37-S00 OAK	59C-E37-S00 MAP	Desk w/Chrome Metal "T" Front	32-3/16" x 70" x 31-3/8"	260	\$10,625	\$11,581		

Inside dimensions are 68"W x 26-3/4"D.
 This sitting height unit has two drawer pedestals, one mounted on each side consisting of one locking drawer at top; one file drawer with hanging file rack at bottom. Two center drawers are mounted between the two pedestals. Two 3" diameter grommets are located in the work surface.
Note: Available in 32-3/16" H only.

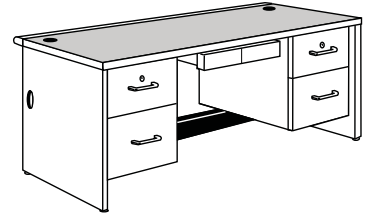

59C-238-S02 OAK	59C-238-S02 MAP	Desk w/Painted Metal "T" Front	39-3/16" x 70" x 31-3/8"	230	\$7,559	\$8,239	Double-Wide	Single Pedestal Work Desk
59C-238-S00 OAK	59C-238-S00 MAP	Desk w/Chrome Metal "T" Front	39-3/16" x 70" x 31-3/8"	230	\$9,068	\$9,885		

Inside dimensions are 68"W x 26-3/4"D.
 This standing height unit has one drawer pedestal mounted on the left side consisting of one locking drawer at top; two file drawers with Pendaflex hangers at the bottom. Two 3" diameter grommets are located in the work surface.

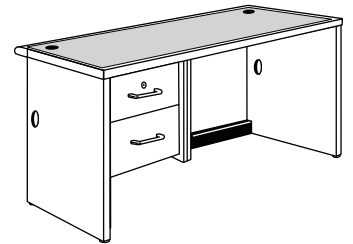

59C-E38-S02 OAK	59C-E38-S02 MAP	Desk w/Painted Metal "T" Front	32-3/16" x 70" x 31-3/8"	195	\$6,990	\$7,619		
59C-E38-S00 OAK	59C-E38-S00 MAP	Desk w/Chrome Metal "T" Front	32-3/16" x 70" x 31-3/8"	195	\$8,386	\$9,141		

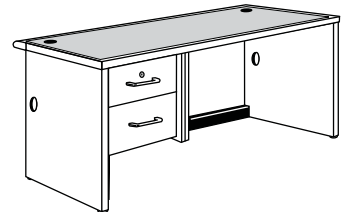

Inside dimensions are 68"W x 26-3/4"D.
 This sitting height unit has one drawer pedestal mounted on the left side consisting of one locking file drawer at top; one file drawer at the bottom, both with hanging file racks. Two 3" diameter grommets are located in the work surface.



Please specify Wood Finish (Table 1), High-Pressure Laminate (Table 2) and Metal Color (Table 3). Details can be found on pages GEN 4 and GEN 5.

The Epoch Collection

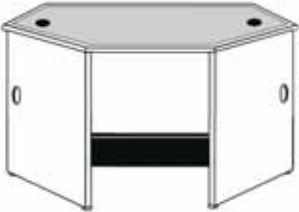

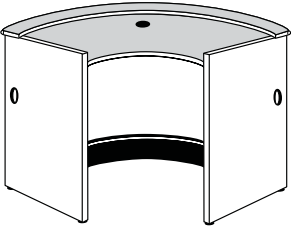
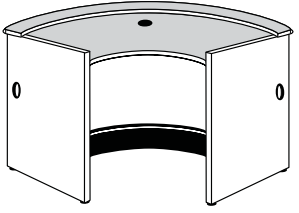

Circulation Desks with Offset Resin Panel Fronts, Corner

Standing	Sitting	Oak Catalog No.	Maple Catalog No.	Description	H x W x D	Wt. (lbs.)	Oak Price	Maple Price
90 Degree Multi-Purpose Corner		59-010-S02 OAK	59-010-S02 MAP	Desk w/Painted Resin Panel Front	39-3/16" x 71-3/4" x 30"	250	\$10,065	\$10,970
		59-010-S00 OAK	59-010-S00 MAP	Desk w/Chrome Resin Panel Front	39-3/16" x 71-3/4" x 30"	250	\$10,868	\$11,847
		59-E10-S02 OAK	59-E10-S02 MAP	Desk w/Painted Resin Panel Front	32-3/16" x 71-3/4" x 30"	215	\$9,953	\$10,849
		59-E10-S00 OAK	59-E10-S00 MAP	Desk w/Chrome Resin Panel Front	32-3/16" x 71-3/4" x 30"	215	\$10,750	\$11,717
90 Degree Multi-Purpose Corner with Patron Service Ledge		59-017-S02 OAK	59-017-S02 MAP	Desk w/Painted Resin Panel Front	39-3/16" x 71-3/4" x 30"	245	\$11,693	\$12,745
		59-017-S00 OAK	59-017-S00 MAP	Desk w/Chrome Resin Panel Front	39-3/16" x 71-3/4" x 30"	245	\$12,412	\$13,529
		59-E17-S02 OAK	59-E17-S02 MAP	Desk w/Painted Resin Panel Front	32-3/16" x 71-3/4" x 30"	210	\$11,564	\$12,604
		59-E17-S00 OAK	59-E17-S00 MAP	Desk w/Chrome Resin Panel Front	32-3/16" x 71-3/4" x 30"	210	\$12,254	\$13,357
90 Degree Open Curved Corner with Patron Service Ledge		59-040-S02 OAK	59-040-S02 MAP	Desk w/Painted Resin Panel Front	39-3/16" x 70-1/8" x 30"	245	\$12,998	\$14,168
		59-040-S00 OAK	59-040-S00 MAP	Desk w/Chrome Resin Panel Front	39-3/16" x 70-1/8" x 30"	245	\$14,037	\$15,301
		59-E40-S02 OAK	59-E40-S02 MAP	Desk w/Painted Resin Panel Front	32-3/16" x 70-1/8" x 30"	210	\$12,855	\$14,012
		59-E40-S00 OAK	59-E40-S00 MAP	Desk w/Chrome Resin Panel Front	32-3/16" x 70-1/8" x 30"	210	\$13,882	\$15,131

Please specify Wood Finish (Table 1), High-Pressure Laminate (Table 2), Metal Color (Table 3) and Resin Option (Table 6). Details can be found on pages GEN 4, GEN 5 and GEN 6.

**Circulation Desks with
Metal "T" Fronts, Corner**

The Epoch Collection

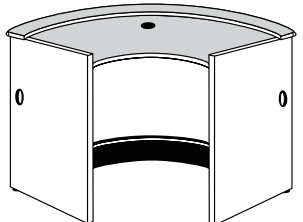
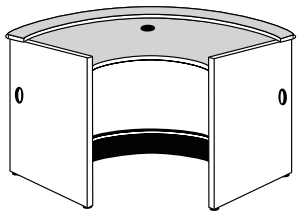
Oak Catalog No.	Maple Catalog No.	Description	H x W x D	Wt. (lbs.)	Oak Price	Maple Price	Standing	Sitting	
59C-010-S02 OAK	59C-010-S02 MAP	Desk w/Painted Metal "T" Front	39-3/16" x 71-3/4" x 30"	250	\$9,296	\$10,132	90 Degree Multi-Purpose Corner		
59C-010-S00 OAK	59C-010-S00 MAP	Desk w/Chrome Metal "T" Front	39-3/16" x 71-3/4" x 30"	250	\$11,155	\$12,159			
		This unit is a standing height unit and has a 29-5/16"W port area. Storage shelves are located in the two angled areas to the left and right of the desk module. One 3" diameter grommet is located in the work-surface top. One 3-1/2" diameter egress with sleeve is located in each end panel for wire passage.							
59C-E10-S02 OAK	59C-E10-S02 MAP	Desk w/Painted Metal "T" Front	32-3/16" x 71-3/4" x 30"	215	\$9,179	\$10,005			
59C-E10-S00 OAK	59C-E10-S00 MAP	Desk w/Chrome Metal "T" Front	32-3/16" x 71-3/4" x 30"	215	\$11,017	\$12,008			
		This unit is a sitting height unit and has a 29-5/16"W port area. Storage shelves are located in the two angled areas to the left and right of the desk module. One 3" diameter grommet is located in the work-surface top. One 3-1/2" diameter egress with sleeve is located in each end panel for wire passage.							
59C-017-S02 OAK	59C-017-S02 MAP	Desk w/Painted Metal "T" Front	39-3/16" x 71-3/4" x 30"	245	\$10,365	\$11,297	90 Degree Multi-Purpose Corner with Patron Service Ledge		
59C-017-S00 OAK	59C-017-S00 MAP	Desk w/Chrome Metal "T" Front	39-3/16" x 71-3/4" x 30"	245	\$12,199	\$13,297			
		This unit is a standing height unit and has a 29-5/16"W port area. The 7-7/8"D patron ledge is at a height of 39-3/16". Work surface is at 35"H. Storage shelves are located in the two angled areas to the left and right of the module. One 3" diameter grommet is located in the work surface top. One 3-1/2" diameter egress with sleeve is located in each end panel for wire passage.							
59C-E17-S02 OAK	59C-E17-S02 MAP	Desk w/Painted Metal "T" Front	32-3/16" x 71-3/4" x 30"	210	\$10,185	\$11,102			
59C-E17-S00 OAK	59C-E17-S00 MAP	Desk w/Chrome Metal "T" Front	32-3/16" x 71-3/4" x 30"	210	\$11,935	\$13,010			
		This unit is a sitting height unit and has a 29-5/16"W port area. The 7-7/8"D patron ledge is at a height of 32-3/16". Work surface is at 28"H. Storage shelves are located in the two angled areas to the left and right of the module. One 3" diameter grommet is located in the work surface top. One 3-1/2" diameter egress with sleeve is located in each end panel for wire passage.							
59C-040-S02 OAK	59C-040-S02 MAP	Desk w/Painted Metal "T" Front	39-3/16" x 70-1/8" x 30"	245	\$11,550	\$12,589	90 Degree Open Curved Corner with Patron Service Ledge		
59C-040-S00 OAK	59C-040-S00 MAP	Desk w/Chrome Metal "T" Front	39-3/16" x 70-1/8" x 30"	245	\$13,860	\$15,108			
		The 7-7/8"D patron ledge is at a height of 39-3/16". The work surface is at 35"H. This unit is a sitting height unit and has a 26-5/8"W port area. Storage shelves are located in the two angled areas to the left and right of the desk module. One 3" diameter grommet is located in the work surface top. One 3-12" diameter egress with sleeve is located in each end panel for wire passage.							
59C-E40-S02 OAK	59C-E40-S02 MAP	Desk w/Painted Metal "T" Front	32-3/16" x 70-1/8" x 30"	210	\$11,406	\$12,433			
59C-E40-S00 OAK	59C-E40-S00 MAP	Desk w/Chrome Metal "T" Front	32-3/16" x 70-1/8" x 30"	210	\$13,689	\$14,921			
		The 7-7/8"D patron ledge is at a height of 32-3/16". The work surface is at 35"H. This unit is a sitting height unit and has a 26-5/8"W port area. Storage shelves are located in the two angled areas to the left and right of the desk module. One 3" diameter grommet is located in the work surface top. One 3-12" diameter egress with sleeve is located in each end panel for wire passage.							

Please specify Wood Finish (Table 1), High-Pressure Laminate (Table 2) and Metal Color (Table 3).
Details can be found on pages GEN 4 and GEN 5.

The Epoch Collection

Circulation Desks with Offset Resin Panel Fronts, Corner

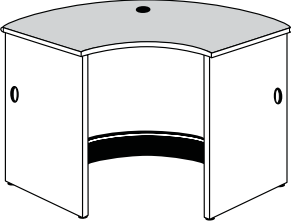
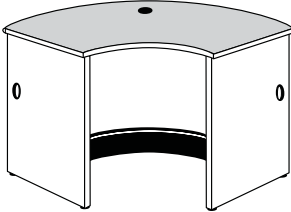
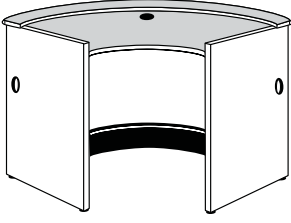
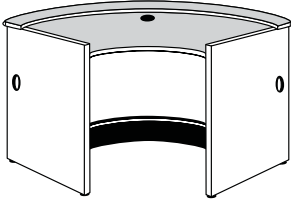
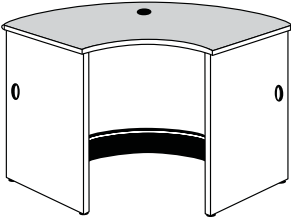
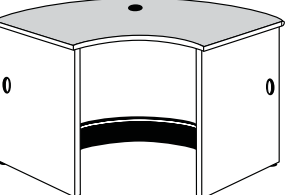
Standing	Sitting	Oak Catalog No.	Maple Catalog No.	Description	H x W x D	Wt. (lbs.)	Oak Price	Maple Price
90 Degree Open Curved Corner		59-041-S02 OAK	59-041-S02 MAP	Desk w/Painted Resin Panel Front	39-3/16" x 70-1/8" x 30"	245	\$12,696	\$13,838
		59-041-S00 OAK	59-041-S00 MAP	Desk w/Chrome Resin Panel Front	39-3/16" x 70-1/8" x 30"	245	\$13,710	\$14,944
		Standing height unit with work surface is at 39-3/16"H. Unit has 26-5/8"W port area. Storage shelves are located in the two angled areas to the left and right of the desk module. One 3" diameter grommet is located in the work-surface top. One 3-1/2" diameter egress with sleeve is located in each end panel for wire passage.						
		59-E41-S02 OAK	59-E41-S02 MAP	Desk w/Painted Resin Panel Front	32-3/16" x 70-1/8" x 30"	210	\$12,509	\$13,635
		59-E41-S00 OAK	59-E41-S00 MAP	Desk w/Chrome Resin Panel Front	32-3/16" x 70-1/8" x 30"	210	\$13,511	\$14,727
		Sitting height unit with work surface is at 32-3/16"H. Unit has 26-5/8"W port area. Storage shelves are located in the two angled areas to the left and right of the desk module. One 3" diameter grommet is located in the work-surface top. One 3-1/2" diameter egress with sleeve is located in each end panel for wire passage.						
60 Degree Curved Corner with Patron Service Ledge		59-047-S02 OAK	59-047-S02 MAP	Desk w/Painted Resin Panel Front	39-3/16" x 80-3/4" x 30"	245	\$14,984	\$16,332
		59-047-S00 OAK	59-047-S00 MAP	Desk w/Chrome Resin Panel Front	39-3/16" x 80-3/4" x 30"	245	\$16,182	\$17,638
		The 7-7/8"D patron ledge is at a height of 39-3/16". Standing height unit with work surface is at 35-7/16"H. Unit has 49-1/16" W port area. Storage shelves are located in the two angled areas to the left and right of the desk module. One 3" diameter grommet is located in the work surface top. One 3-1/2" diameter egress with sleeve is located in each end panel for wire passage.						
		59-E47-S02 OAK	59-E47-S02 MAP	Desk w/Painted Resin Panel Front	32-3/16" x 80-3/4" x 30"	210	\$14,818	\$16,151
		59-E47-S00 OAK	59-E47-S00 MAP	Desk w/Chrome Resin Panel Front	32-3/16" x 80-3/4" x 30"	210	\$16,002	\$17,442
		The 7-7/8"D patron ledge is at a height of 32-3/16". Standing height unit with work surface is at 35-7/16"H. Unit has 49-1/16" W port area. Storage shelves are located in the two angled areas to the left and right of the desk module. One 3" diameter grommet is located in the work surface top. One 3-1/2" diameter egress with sleeve is located in each end panel for wire passage.						
60 Degree Curved Corner		59-048-S02 OAK	59-048-S02 MAP	Desk w/Painted Resin Panel Front	39-3/16" x 80-3/4" x 30"	245	\$14,447	\$15,747
		59-048-S00 OAK	59-048-S00 MAP	Desk w/Chrome Resin Panel Front	39-3/16" x 80-3/4" x 30"	245	\$15,601	\$17,005
		Standing height unit with work surface is at 39-3/16"H. Unit has 49-1/16"W port area. Storage shelves are located in the two angled areas to the left and right of the desk module. One 3" diameter grommet is located in the work surface top. One 3-1/2" diameter egress with sleeve is located in each end panel for wire passage.						
		59-E48-S02 OAK	59-E48-S02 MAP	Desk w/Painted Resin Panel Front	32-3/16" x 80-3/4" x 30"	210	\$14,279	\$15,564
		59-E48-S00 OAK	59-E48-S00 MAP	Desk w/Chrome Resin Panel Front	32-3/16" x 80-3/4" x 30"	210	\$15,421	\$16,808
		Standing height unit with work surface is at 32-3/16"H. Unit has 49-1/16"W port area. Storage shelves are located in the two angled areas to the left and right of the desk module. One 3" diameter grommet is located in the work surface top. One 3-1/2" diameter egress with sleeve is located in each end panel for wire passage.						

Please specify Wood Finish (Table 1), High-Pressure Laminate (Table 2), Metal Color (Table 3) and Resin Option (Table 6). Details can be found on pages GEN 4, GEN 5 and GEN 6.

**Circulation Desks with
Metal "T" Fronts, Corner**

The Epoch Collection

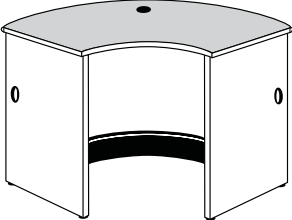
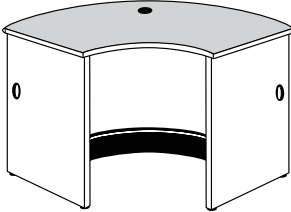
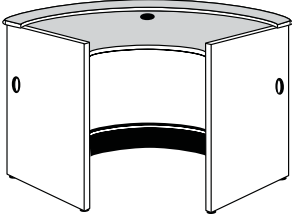
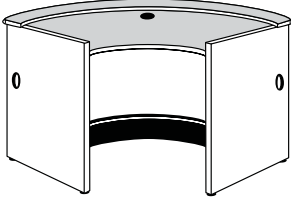
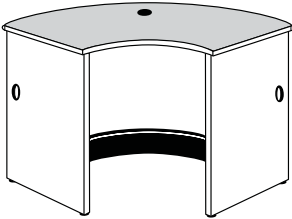
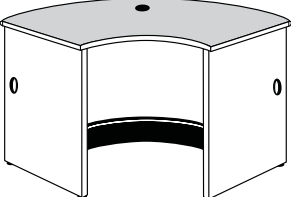
Oak Catalog No.	Maple Catalog No.	Description	H x W x D	Wt. (lbs.)	Oak Price	Maple Price	Standing	Sitting	
59C-041-S02 OAK	59C-041-S02 MAP	Desk w/Painted Metal "T" Front	39-3/16" x 70-1/8" x 30"	245	\$11,247	\$12,259		90 Degree Open Curved Corner	
59C-041-S00 OAK	59C-041-S00 MAP	Desk w/Chrome Metal "T" Front	39-3/16" x 70-1/8" x 30"	245	\$13,496	\$14,711			
		<p>Standing height unit with work surface is at 39-3/16"H. Unit has 26-5/8"W port area. Storage shelves are located in the two angled areas to the left and right of the desk module. One 3" diameter grommet is located in the work-surface top. One 3-1/2" diameter egress with sleeve is located in each end panel for wire passage.</p>							
59C-E41-S02 OAK	59C-E41-S02 MAP	Desk w/Painted Metal "T" Front	32-3/16" x 70-1/8" x 30"	210	\$11,077	\$12,074			
59C-E41-S00 OAK	59C-E41-S00 MAP	Desk w/Chrome Metal "T" Front	32-3/16" x 70-1/8" x 30"	210	\$13,294	\$14,490			
		<p>Sitting height unit with work surface is at 32-3/16"H. Unit has 26-5/8"W port area. Storage shelves are located in the two angled areas to the left and right of the desk module. One 3" diameter grommet is located in the work-surface top. One 3-1/2" diameter egress with sleeve is located in each end panel for wire passage.</p>							
59C-047-S02 OAK	59C-047-S02 MAP	Desk w/Painted Metal "T" Front	39-3/16" x 80-3/4" x 30"	245	\$13,795	\$15,037		60 Degree Curved Corner with Patron Service Ledge	
59C-047-S00 OAK	59C-047-S00 MAP	Desk w/Chrome Metal "T" Front	39-3/16" x 80-3/4" x 30"	245	\$16,553	\$18,042			
		<p>The 7-7/8"D patron ledge is at a height of 39-3/16". Standing height unit with work surface is at 35-7/16"H. Unit has 49-1/16" W port area. Storage shelves are located in the two angled areas to the left and right of the desk module. One 3" diameter grommet is located in the work surface top. One 3-1/2" diameter egress with sleeve is located in each end panel for wire passage.</p>							
59C-E47-S02 OAK	59C-E47-S02 MAP	Desk w/Painted Metal "T" Front	32-3/16" x 80-3/4" x 30"	210	\$13,627	\$14,854			
59C-E47-S00 OAK	59C-E47-S00 MAP	Desk w/Chrome Metal "T" Front	32-3/16" x 80-3/4" x 30"	210	\$16,353	\$17,824			
		<p>The 7-7/8"D patron ledge is at a height of 32-3/16". Standing height unit with work surface is at 35-7/16"H. Unit has 49-1/16" W port area. Storage shelves are located in the two angled areas to the left and right of the desk module. One 3" diameter grommet is located in the work surface top. One 3-1/2" diameter egress with sleeve is located in each end panel for wire passage.</p>							
59C-048-S02 OAK	59C-048-S02 MAP	Desk w/Painted Metal "T" Front	39-3/16" x 80-3/4" x 30"	245	\$13,257	\$14,450		60 Degree Curved Corner	
59C-048-S00 OAK	59C-048-S00 MAP	Desk w/Chrome Metal "T" Front	39-3/16" x 80-3/4" x 30"	245	\$15,908	\$17,340			
		<p>Standing height unit with work surface is at 39-3/16"H. Unit has 49-1/16"W port area. Storage shelves are located in the two angled areas to the left and right of the desk module. One 3" diameter grommet is located in the work surface top. One 3-1/2" diameter egress with sleeve is located in each end panel for wire passage.</p>							
59C-E48-S02 OAK	59C-E48-S02 MAP	Desk w/Painted Metal "T" Front	32-3/16" x 80-3/4" x 30"	210	\$13,089	\$14,267			
59C-E48-S00 OAK	59C-E48-S00 MAP	Desk w/Chrome Metal "T" Front	32-3/16" x 80-3/4" x 30"	210	\$15,707	\$17,121			
		<p>Standing height unit with work surface is at 32-3/16"H. Unit has 49-1/16"W port area. Storage shelves are located in the two angled areas to the left and right of the desk module. One 3" diameter grommet is located in the work surface top. One 3-1/2" diameter egress with sleeve is located in each end panel for wire passage.</p>							

Please specify Wood Finish (Table 1), High-Pressure Laminate (Table 2) and Metal Color (Table 3).
Details can be found on pages GEN 4 and GEN 5.

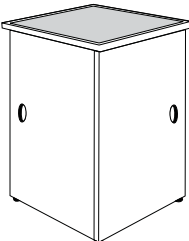
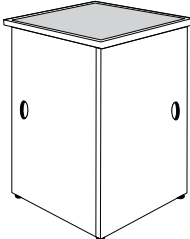
Standing	Sitting	Oak Catalog No.	Maple Catalog No.	Description	H x W x D	Wt. (lbs.)	Oak Price	Maple Price
90 Degree Square Corner Unit		59-150-S02 OAK	59-150-S02 MAP	Desk w/Painted Resin Panel Front	39-3/16" x 30" x 30"	160	\$6,959	\$7,585
		59-150-S00 OAK	59-150-S00 MAP	Desk w/Chrome Resin Panel Front	39-3/16" x 30" x 30"	160	\$7,513	\$8,189
				This square corner unit is used to form a right angle in a desk arrangement. One 3" diameter egress is located in each end panel for wire passage through a continuous ABS tube.				
		59-E50-S02 OAK	59-E50-S02 MAP	Desk w/Painted Resin Panel Front	32-3/16" x 30" x 30"	140	\$5,744	\$6,261
		59-E50-S00 OAK	59-E50-S00 MAP	Desk w/Chrome Resin Panel Front	32-3/16" x 30" x 30"	140	\$6,205	\$6,763
				This square corner unit is used to form a right angle in a desk arrangement. One 3" diameter egress is located in each end panel for wire passage through a continuous ABS tube.				

Please specify Wood Finish (Table 1), High-Pressure Laminate (Table 2), Metal Color (Table 3) and Resin Option (Table 6). Details can be found on pages GEN 4, GEN 5 and GEN 6.

Circulation Desks
Metal "T" Fronts, Corner

The Epoch Collection

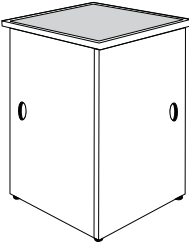
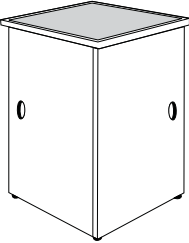
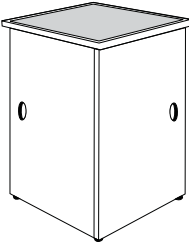
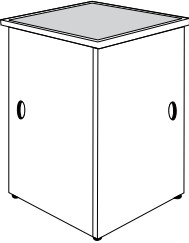
Oak Catalog No.	Maple Catalog No.	Description	H x W x D	Wt. (lbs.)	Oak Price	Maple Price	Standing	Sitting
59C-150-S02 OAK	59C-150-S02 MAP	Desk w/Painted Metal "T" Front	39-3/16" x 30" x 30"	160	\$6,333	\$6,903		
59C-150-S00 OAK	59C-150-S00 MAP	Desk w/Chrome Metal "T" Front	39-3/16" x 30" x 30"	160	\$7,599	\$8,284		
<p>This square corner unit is used to form a right angle in a desk arrangement. One 3" diameter egress is located in each end panel for wire passage through a continuous ABS tube.</p>								
59C-E50-S02 OAK	59C-E50-S02 MAP	Desk w/Painted Metal "T" Front	32-3/16" x 30" x 30"	140	\$5,120	\$5,581		
59C-E50-S00 OAK	59C-E50-S00 MAP	Desk w/Chrome Metal "T" Front	32-3/16" x 30" x 30"	140	\$6,143	\$6,696		
<p>This square corner unit is used to form a right angle in a desk arrangement. One 3" diameter egress is located in each end panel for wire passage through a continuous ABS tube.</p>								

Please specify Wood Finish (Table 1), High-Pressure Laminate (Table 2) and Metal Color (Table 3). Details can be found on pages GEN 4 and GEN 5.

	Oak Catalog No.	Maple Catalog No.	Description	H x W x D	Wt. (lbs.)	Oak Price	Maple Price
--	--------------------	----------------------	-------------	-----------	---------------	--------------	----------------

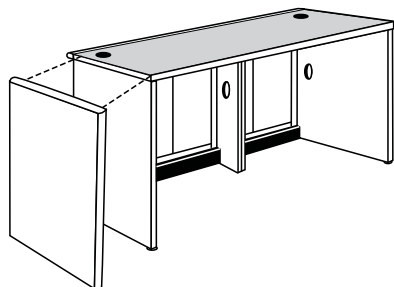

Detachable End Panels (Pair)	59-178-S00 OAK	59-178-S00 MAP	Detachable End Panels (Pair) End panels are 1" thick, 3-ply, 45# density particleboard core with plain-sliced oak or maple veneers. Exposed edges are externally banded with 1.6mm thick, Northern-grown Oak or maple edge band.	39" x 1" x 26-3/4"	52	\$1,804	\$1,966
-------------------------------------	----------------	----------------	---	--------------------	----	---------	---------

	59-E78-S00 OAK	59-E78-S00 MAP	Detachable End Panels (Pair) End panels are 1" thick, 3-ply, 45# density particleboard core with plain-sliced oak or maple veneers. Exposed edges are externally banded with 1.6mm thick, Northern-grown Oak or maple edge band.	32" x 1" x 26-3/4"	42	\$1,532	\$1,670
--	----------------	----------------	---	--------------------	----	---------	---------

Single-Wide Add On 7"H Patron Ledge

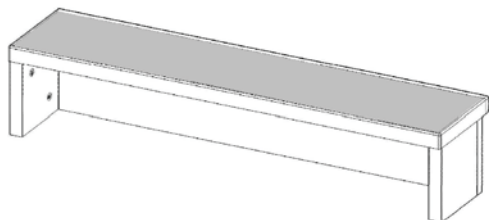

	59-196-S00 OAK	59-196-S00 MAP	Single-Wide Add On 7"H Patron Ledge Unit is designed to be added onto a single wide desk without a patron ledge. The Patron Ledge Assembly will attach to the desktop by means of #8 x 2-1/2" screws inserted through the work surface into the ledge assembly.	7" x 35" x 7-7/8"	10	\$974	\$1,061
--	----------------	----------------	---	-------------------	----	-------	---------

Double-Wide Add On 7"H Patron Ledge

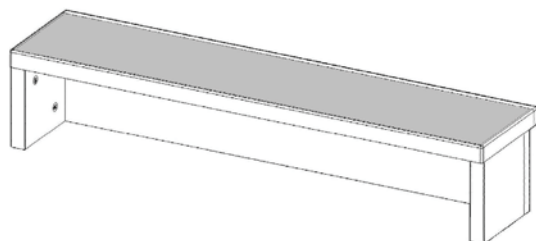

	59-197-S00 OAK	59-197-S00 MAP	Double-Wide Add On 7"H Patron Ledge Unit is designed to be added onto a double wide desk without a patron ledge. The Patron Ledge Assembly will attach to the desktop by means of #8 x 2-1/2" screws inserted through the work surface into the ledge assembly.	7" x 70" x 7-7/8"	20	\$1,099	\$1,198
--	----------------	----------------	---	-------------------	----	---------	---------

Please specify Wood Finish (Table 1) and High-Pressure Laminate (Table 2). Details can be found on page GEN 4.

General Specifications

TABLETOPS

Tabletops are 1-3/16" thick, 3-ply 45# density particleboard core or with a .050" high-pressure laminate with a .020" thick phenolic backing sheet on the underside. High-pressure laminate has a low-glare finish resistant to scratches, fading and staining in accordance with NEMA standards. Tabletops are banded on exposed edges with a 1-3/4" thick x 2" wide solid maple external chamfered edge band applied to the table core after lamination of the face plastic. The edge band is beveled down at a 20° angle with a 1/2" radius bullnose at the leading edge. Square and rectangular tabletop edge bands are mitered at all four corners and corners radiused 1/8".

LEGS (CHROME)

Legs are 2-1/2" round, 16-gauge steel tubing. The table is without an apron, with legs attached to the tabletop by a 5" square x 5/16" thick steel plate. Leg and plate are painted or plated to match the leg (see chrome specifications) and have no sharp edges. The plate is attached to the leg by a 9" x 3" x 3/8" steel angle bracket placed at a 45° angle. The steel angle bracket receives two cutout designs replicating the edge band profile. The bracket is attached to the leg plate and leg using metal to metal fasteners. The leg plate is attached to the tabletop by (5) 5/16" x 1" machine bolts engaging internally and externally threaded bushings embedded in the underside of the tabletop. Leg plates are positioned behind and hidden by the extended edge band. Edge band extends 1/2" below the tabletop. Each leg has 2-1/2"D x 1"H adjustable glide mounted into a recessed threaded insert.

LEG (WIRE MANAGEMENT)

A 1/2" wide slot is located in the back of the leg underneath the angle support bracket, 5/8" down from the top of the leg to within 3-3/8" of the bottom of the leg. To insert cords, a snap on slot cover of 1/8" bent metal and finished to match the leg is supplied to snap on after the cord is put into the slot. The snap on cover allows for a 1" egress at the top and bottom of the slot for cords.

CHROME PLATING SPECIFICATION

Where chrome plated is specified, Brodart uses a decorative chromium electro-plated finish that protects against tarnish and minimizes scratching. Brodart Class AA chrome plating requires a .004" to .005" thick layer of bright nickel and a layer of chromium to produce a high-quality furniture grade finish.

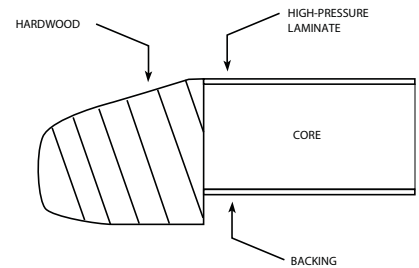

Epoch Edge Detail

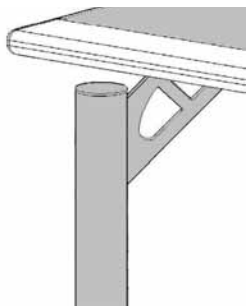

Epoch Chrome Leg Cutout

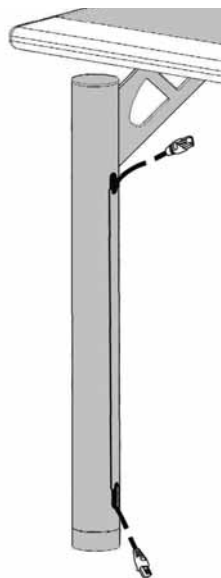

Epoch Wire Management Chrome Leg

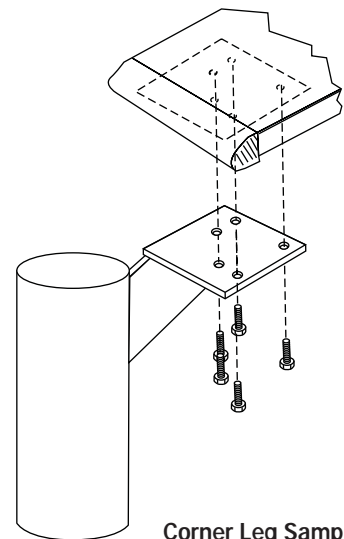

Corner Leg Sample

	Plywood Core Catalog No.	Particleboard Core Catalog No.	Description	H x W x D	Wt. (lbs.)	Plywood Core Price	Particleboard Core Price
Round Table							
	<u>Round Oak Table with Chrome Legs</u>						
	59C-109-S00 OAK	59C-109-S02 OAK	Round Table	29"H x 38" Diameter	100	\$2,925	\$2,768
	59C-129-S00 OAK	59C-129-S02 OAK	Round Table	29"H x 44" Diameter	110	\$3,039	\$2,880
	59C-141-S00 OAK	59C-141-S02 OAK	Round Table	29"H x 50" Diameter	120	\$3,227	\$3,002
	N/A	59C-130-S02 OAK	Round Table	29"H x 62" Diameter	140	N/A	\$3,628
	<u>Round Maple Table with Chrome Legs</u>						
	59C-109-S00 MAP	59C-109-S02 MAP	Round Table	29"H x 38" Diameter	100	\$3,188	\$3,017
	59C-129-S00 MAP	59C-129-S02 MAP	Round Table	29"H x 44" Diameter	110	\$3,312	\$3,140
	59C-141-S00 MAP	59C-141-S02 MAP	Round Table	29"H x 50" Diameter	120	\$3,517	\$3,272
	N/A	59C-130-S02 MAP	Round Table	29"H x 62" Diameter	140	N/A	\$3,955
Square Table							
	<u>Square Oak Table with Chrome Legs</u>						
	59C-191-S00 OAK	59C-191-S02 OAK	Square Table	29" x 32-3/4" x 32-3/4"	100	\$3,025	\$2,698
	59C-137-S00 OAK	59C-137-S02 OAK	Square Table	29" x 44-3/4" x 44-3/4"	100	\$3,139	\$2,812
	59C-154-S00 OAK	59C-154-S02 OAK	Square Table	29" x 50-3/4" x 50-3/4"	100	\$3,265	\$2,939
	<u>Square Maple Table with Chrome Legs</u>						
	59C-191-S00 MAP	59C-191-S02 MAP	Square Table	29" x 32-3/4" x 32-3/4"	100	\$3,297	\$2,941
	59C-137-S00 MAP	59C-137-S02 MAP	Square Table	29" x 44-3/4" x 44-3/4"	100	\$3,421	\$3,066
	59C-154-S00 MAP	59C-154-S02 MAP	Square Table	29" x 50-3/4" x 50-3/4"	100	\$3,559	\$3,203
Four Reader Rectangular Table							
	<u>Rectangular Oak Table with Chrome Legs</u>						
	59C-194-S00 OAK	59C-194-S02 OAK	Rectangular Table	29" x 62-3/4" x 32-3/4"	110	\$3,309	\$3,111
	59C-195-S00 OAK	59C-195-S02 OAK	Rectangular Table	29" x 74-3/4" x 32-3/4"	130	\$3,429	\$3,239
	59C-144-S00 OAK	59C-144-S02 OAK	Rectangular Table	29" x 62-3/4" x 38-3/4"	110	\$3,385	\$3,187
	59C-138-S00 OAK	59C-138-S02 OAK	Rectangular Table	29" x 74-3/4" x 38-3/4"	130	\$3,504	\$3,314
	59C-145-S00 OAK	59C-145-S02 OAK	Rectangular Table	29" x 74-3/4" x 50-3/4"	160	\$3,788	\$3,551
	<u>Rectangular Maple Table with Chrome Legs</u>						
	59C-194-S00 MAP	59C-194-S02 MAP	Rectangular Table	29" x 62-3/4" x 32-3/4"	110	\$3,606	\$3,390
	59C-195-S00 MAP	59C-195-S02 MAP	Rectangular Table	29" x 74-3/4" x 32-3/4"	130	\$3,738	\$3,530
	59C-144-S00 MAP	59C-144-S02 MAP	Rectangular Table	29" x 62-3/4" x 38-3/4"	110	\$3,690	\$3,474
	59C-138-S00 MAP	59C-138-S02 MAP	Rectangular Table	29" x 74-3/4" x 38-3/4"	130	\$3,819	\$3,613
	59C-145-S00 MAP	59C-145-S02 MAP	Rectangular Table	29" x 74-3/4" x 50-3/4"	160	\$4,129	\$3,871
Six Reader Rectangular Table with Center Support Legs							
	<u>Rectangular Oak Table with Chrome Legs</u>						
	59C-198-S00 OAK	59C-198-S02 OAK	Rectangular Table	29" x 92-3/4" x 32-3/4"	150	\$4,844	\$4,563
	59C-146-S00 OAK	59C-146-S02 OAK	Rectangular Table	29" x 92-3/4" x 38-3/4"	150	\$4,920	\$4,638
	59C-134-S00 OAK	59C-134-S02 OAK	Rectangular Table	29" x 92-3/4" x 50-3/4"	200	\$5,368	\$4,902
	<u>Rectangular Maple Table with Chrome Legs</u>						
	59C-198-S00 MAP	59C-198-S02 MAP	Rectangular Table	29" x 92-3/4" x 32-3/4"	150	\$5,280	\$4,974
	59C-146-S00 MAP	59C-146-S02 MAP	Rectangular Table	29" x 92-3/4" x 38-3/4"	150	\$5,363	\$5,055
	59C-134-S00 MAP	59C-134-S02 MAP	Rectangular Table	29" x 92-3/4" x 50-3/4"	200	\$5,851	\$5,343
Chrome Wire Management Leg	59C-945-S00		Optional Leg	29"H	12		\$639
	Please specify Wood Finish (Table 1) and High-Pressure Laminate (Table 2). Details can be found on page GEN 4.						

General Specifications

TABLETOPS

Tabletops are 1-3/16" thick, 3-ply 45# density particleboard core or with a .050" high-pressure laminate face a .020" thick phenolic backing sheet on the underside. High-pressure laminate has a low-glare finish resistant to scratches, fading and staining in accordance with NEMA standards. Tabletops are banded on exposed edges with a 2" wide x 1-3/4" thick solid maple external chamfered edge band applied to the table core after lamination of the face plastic. The edge band is beveled down at a 20° angle with a 1/2" radius bullnose at the leading edge. Square and rectangular tabletop edge bands are mitered and receive 1/8" radius on all corners.

LEGS (POWDER-COATED)

Legs are 2-1/2" round, 16-gauge steel tubing. The table is without an apron, with legs attached to the tabletop by a 5" square x 5/16" thick steel plate. Legs and plates are electrostatic powder-coat painted and have no sharp edges. The plate attaches to the leg by a 9" x 3" x 3/8" steel angle bracket placed at a 45° angle. The steel angle bracket receives two cutout designs replicating the edge band profile. The steel bracket is attached to the leg plate and leg using metal to metal fasteners. The strap may be electrostatic powder-coat painted or chrome plated. The leg plate is attached to the tabletop by (5) 5/16" x 1" machine bolts engaging internally and externally threaded bushings embedded in the underside of the tabletop. Leg plates are positioned behind, and hidden by the extended edge band. Edge band extends 1/2" below the tabletop. Each leg has 2-1/2"D x 1"H adjustable glide mounted into a recessed threaded insert.

LEG (WIRE MANAGEMENT)

A 1/2" wide slot is located in the back of the leg underneath the angle support bracket, 5/8" down from the top of the leg to within 3-3/8" of the bottom of the leg. To insert cords, a snap on slot cover of 1/8" bent metal and finished to match the leg is supplied to snap on after the cord is put into the slot. The snap on cover allows for a 1" egress at the top and bottom of the slot for cords.

CHROME PLATING SPECIFICATION

Where chrome plated is specified, Brodart uses a decorative chromium electro-plated finish that protects against tarnish and minimizes scratching. Brodart Class AA chrome plating requires a .004" to .005" thick layer of bright nickel and a layer of chromium to produce a high-quality furniture grade finish.

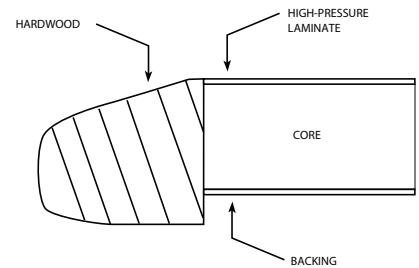

Epoch Series Edge

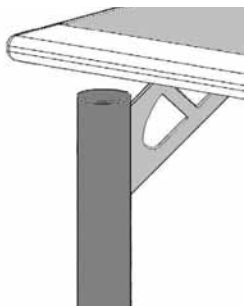



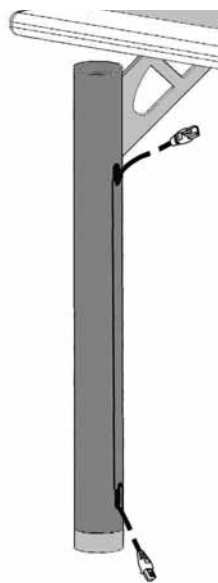



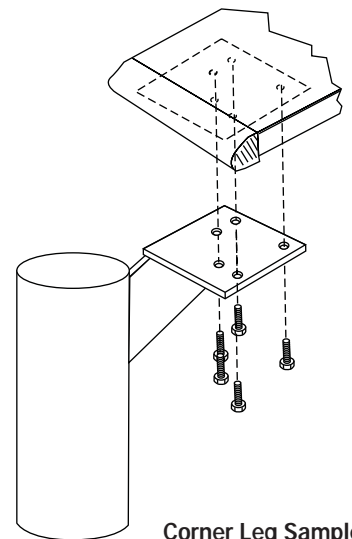

Epoch Powder-Coated Leg Cutout



Epoch Wire Management Powder-Coated Leg

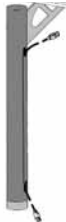

Corner Leg Sample

	Plywood Core Catalog No.	Particleboard Core Catalog No.	Description	H x W x D	Wt. (lbs.)	Plywood Core Price	Particleboard Core Price
Round Table							
	<u>Round Oak Table with Powder-Coated Legs</u>						
	59-109-S00 OAK	59-109-S02 OAK	Round Table	29"H x 38" Diameter	100	\$2,366	\$2,208
	59-129-S00 OAK	59-129-S02 OAK	Round Table	29"H x 44" Diameter	110	\$2,479	\$2,323
	59-141-S00 OAK	59-141-S02 OAK	Round Table	29"H x 50" Diameter	120	\$2,667	\$2,442
	N/A	59-130-S02 OAK	Round Table	29"H x 62" Diameter	140	N/A	\$3,067
	<u>Round Maple Table with Powder-Coated Legs</u>						
	59-109-S00 MAP	59-109-S02 MAP	Round Table	29"H x 38" Diameter	100	\$2,579	\$2,406
	59-129-S00 MAP	59-129-S02 MAP	Round Table	29"H x 44" Diameter	110	\$2,702	\$2,532
	59-141-S00 MAP	59-141-S02 MAP	Round Table	29"H x 50" Diameter	120	\$2,907	\$2,661
	N/A	59-130-S02 MAP	Round Table	29"H x 62" Diameter	140	N/A	\$3,343
Square Table							
	<u>Square Oak Table with Powder-Coated Legs</u>						
	59-191-S00 OAK	59-191-S02 OAK	Square Table	29" x 32-3/4" x 32-3/4"	100	\$2,295	\$2,137
	59-137-S00 OAK	59-137-S02 OAK	Square Table	29" x 44-3/4" x 44-3/4"	100	\$2,408	\$2,252
	59-154-S00 OAK	59-154-S02 OAK	Square Table	29" x 50-3/4" x 50-3/4"	100	\$2,536	\$2,378
	<u>Square Maple Table with Powder-Coated Legs</u>						
	59-191-S00 MAP	59-191-S02 MAP	Square Table	29" x 32-3/4" x 32-3/4"	100	\$2,502	\$2,329
	59-137-S00 MAP	59-137-S02 MAP	Square Table	29" x 44-3/4" x 44-3/4"	100	\$2,624	\$2,455
	59-154-S00 MAP	59-154-S02 MAP	Square Table	29" x 50-3/4" x 50-3/4"	100	\$2,764	\$2,592
Four Reader Rectangular Table							
	<u>Rectangular Oak Table with Powder-Coated Legs</u>						
	59-194-S00 OAK	59-194-S02 OAK	Rectangular Table	29" x 62-3/4" x 32-3/4"	110	\$2,722	\$2,525
	59-195-S00 OAK	59-195-S02 OAK	Rectangular Table	29" x 74-3/4" x 32-3/4"	130	\$2,835	\$2,646
	59-144-S00 OAK	59-144-S02 OAK	Rectangular Table	29" x 62-3/4" x 38-3/4"	110	\$2,799	\$2,602
	59-138-S00 OAK	59-138-S02 OAK	Rectangular Table	29" x 74-3/4" x 38-3/4"	130	\$2,913	\$2,725
	59-145-S00 OAK	59-145-S02 OAK	Rectangular Table	29" x 74-3/4" x 50-3/4"	160	\$3,231	\$2,931
	<u>Rectangular Maple Table with Powder-Coated Legs</u>						
	59-194-S00 MAP	59-194-S02 MAP	Rectangular Table	29" x 62-3/4" x 32-3/4"	110	\$2,967	\$2,752
	59-195-S00 MAP	59-195-S02 MAP	Rectangular Table	29" x 74-3/4" x 32-3/4"	130	\$3,090	\$2,885
	59-144-S00 MAP	59-144-S02 MAP	Rectangular Table	29" x 62-3/4" x 38-3/4"	110	\$3,051	\$2,836
	59-138-S00 MAP	59-138-S02 MAP	Rectangular Table	29" x 74-3/4" x 38-3/4"	130	\$3,176	\$2,970
	59-145-S00 MAP	59-145-S02 MAP	Rectangular Table	29" x 74-3/4" x 50-3/4"	160	\$3,522	\$3,195
Six Reader Rectangular Table with Center Support Legs							
	<u>Rectangular Oak Table with Powder-Coated Legs</u>						
	59-198-S00 OAK	59-198-S02 OAK	Rectangular Table	29" x 92-3/4" x 32-3/4"	150	\$3,958	\$3,674
	59-146-S00 OAK	59-146-S02 OAK	Rectangular Table	29" x 92-3/4" x 38-3/4"	150	\$4,033	\$3,750
	59-134-S00 OAK	59-134-S02 OAK	Rectangular Table	29" x 92-3/4" x 50-3/4"	200	\$4,478	\$4,054
	<u>Rectangular Maple Table with Powder-Coated Legs</u>						
	59-198-S00 MAP	59-198-S02 MAP	Rectangular Table	29" x 92-3/4" x 32-3/4"	150	\$4,314	\$4,004
	59-146-S00 MAP	59-146-S02 MAP	Rectangular Table	29" x 92-3/4" x 38-3/4"	150	\$4,396	\$4,088
	59-134-S00 MAP	59-134-S02 MAP	Rectangular Table	29" x 92-3/4" x 50-3/4"	200	\$4,881	\$4,419
Powder-Coated Wire Management Leg	59-945-S00		Optional Leg	29"H	12		\$323
	Please specify Wood Finish (Table 1), High-Pressure Laminate (Table 2) and Metal Color; if applicable (Table 3). Details can be found on pages GEN 4 and GEN 5.						

General Specifications

TABLETOPS

Tabletops are 1-3/16" thick, 3-ply 45# density particleboard core or lumbercore with a .050" high-pressure laminate face a .020" thick phenolic backing sheet on the underside. High-pressure laminate has a low-glare finish resistant to scratches, fading and staining in accordance with NEMA standards. Tabletops are banded on exposed edges with a 2" wide x 1-3/4" thick solid maple external chamfered edge band applied to the table core after lamination of the face plastic. The edge band is beveled down at a 20° angle with a 1/2" radius bullnose at the leading edge. Square and rectangular tabletop edge bands are mitered and receive 1/8" radius on all corners.

LEGS (WOOD)

Legs are 2-1/2" round wood. The table is without an apron, with legs attached to the tabletop by a 5" square x 5/16" thick steel plate. Plates are electrostatic powder coat painted and have no sharp edges. The plate attaches to the leg by a 9" x 3" x 3/8" steel angle bracket placed at a 45° angle. The steel angle bracket receives two cutout designs replicating the edge band profile. The steel bracket is attached to the leg plate and leg using metal to metal fasteners. The strap may be electrostatic powder-coat painted or chrome plated. The leg plate is attached to the tabletop by (5) 5/16" x 1" machine bolts engaging internally and externally threaded bushings embedded in the underside of the tabletop. Leg plates are positioned behind, and hidden by the extended edge band. Edge band extends 1/2" below the tabletop. Each leg has 2-1/2"D x 1"H adjustable glide mounted into a recessed threaded insert.

LEG (WIRE MANAGEMENT)

A 1/2" wide slot is located in the back of the leg underneath the angle support bracket, 5/8" down from the top of the leg to within 3-3/8" of the bottom of the leg. To insert cords, a snap on slot cover of 1/8" bent metal and finished to match the leg is supplied to snap on after the cord is put into the slot. The snap on cover allows for a 1" egress at the top and bottom of the slot for cords.

CHROME PLATING SPECIFICATION

Where chrome plated is specified, Brodart uses a decorative chromium electro-plated finish that protects against tarnish and minimizes scratching. Brodart Class AA chrome plating requires a .004" to .005" thick layer of bright nickel and a layer of chromium to produce a high-quality furniture grade finish.

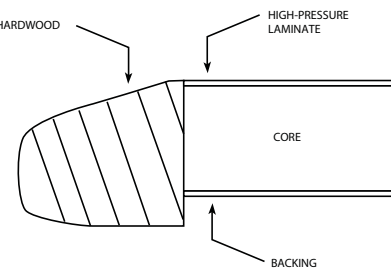

Epoch Series Edge

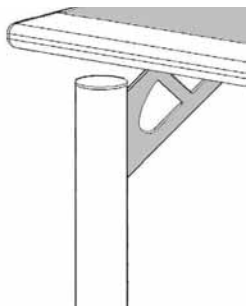





Epoch Wood Leg Cutout

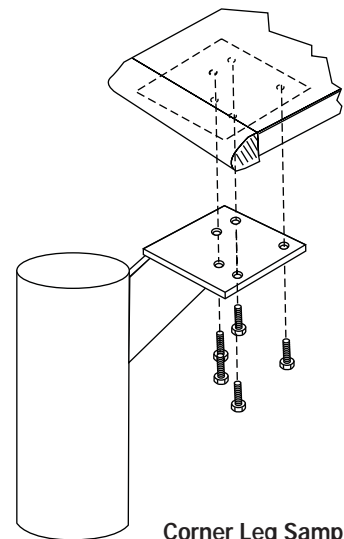

Epoch Wire Management Leg



Corner Leg Sample

	Plywood Core Catalog No.	Particleboard Core Catalog No.	Description	H x W x D	Wt. (lbs.)	Plywood Core Price	Particleboard Core Price	
Round Table								
	<u>Round Oak Table with Wood Legs</u>							
	59W-109-S00 OAK	59W-109-S02 OAK	Round Table	29"H x 38" Diameter	100	\$2,366	\$2,208	
	59W-129-S00 OAK	59W-129-S02 OAK	Round Table	29"H x 44" Diameter	110	\$2,479	\$2,323	
	59W-141-S00 OAK	59W-141-S02 OAK	Round Table	29"H x 50" Diameter	120	\$2,667	\$2,442	
	N/A	59W-130-S02 OAK	Round Table	29"H x 62" Diameter	140	N/A	\$3,067	
	<u>Round Maple Table with Wood Legs</u>							
	59W-109-S00 MAP	59W-109-S02 MAP	Round Table	29"H x 38" Diameter	100	\$2,579	\$2,406	
59W-129-S00 MAP	59W-129-S02 MAP	Round Table	29"H x 44" Diameter	110	\$2,702	\$2,532		
59W-141-S00 MAP	59W-141-S02 MAP	Round Table	29"H x 50" Diameter	120	\$2,907	\$2,661		
N/A	59W-130-S02 MAP	Round Table	29"H x 62" Diameter	140	N/A	\$3,343		
Square Table								
	<u>Square Oak Table with Wood Legs</u>							
	59W-191-S00 OAK	59W-191-S02 OAK	Square Table	29" x 32-3/4" x 32-3/4"	100	\$2,295	\$2,137	
	59W-137-S00 OAK	59W-137-S02 OAK	Square Table	29" x 44-3/4" x 44-3/4"	100	\$2,408	\$2,252	
	59W-154-S00 OAK	59W-154-S02 OAK	Square Table	29" x 50-3/4" x 50-3/4"	100	\$2,536	\$2,378	
	<u>Square Maple Table with Wood Legs</u>							
	59W-191-S00 MAP	59W-191-S02 MAP	Square Table	29" x 32-3/4" x 32-3/4"	100	\$2,502	\$2,329	
	59W-137-S00 MAP	59W-137-S02 MAP	Square Table	29" x 44-3/4" x 44-3/4"	100	\$2,624	\$2,455	
59W-154-S00 MAP	59W-154-S02 MAP	Square Table	29" x 50-3/4" x 50-3/4"	100	\$2,764	\$2,592		
Four Reader Rectangular Table								
	<u>Rectangular Oak Table with Wood Legs</u>							
	59W-194-S00 OAK	59W-194-S02 OAK	Rectangular Table	29" x 62-3/4" x 32-3/4"	110	\$2,722	\$2,525	
	59W-195-S00 OAK	59W-195-S02 OAK	Rectangular Table	29" x 74-3/4" x 32-3/4"	130	\$2,835	\$2,648	
	59W-144-S00 OAK	59W-144-S02 OAK	Rectangular Table	29" x 62-3/4" x 38-3/4"	110	\$2,799	\$2,602	
	59W-138-S00 OAK	59W-138-S02 OAK	Rectangular Table	29" x 74-3/4" x 38-3/4"	130	\$2,913	\$2,725	
	59W-145-S00 OAK	59W-145-S02 OAK	Rectangular Table	29" x 74-3/4" x 50-3/4"	160	\$3,231	\$2,931	
	<u>Rectangular Maple Table with Wood Legs</u>							
	59W-194-S00 MAP	59W-194-S02 MAP	Rectangular Table	29" x 62-3/4" x 32-3/4"	110	\$2,967	\$2,752	
	59W-195-S00 MAP	59W-195-S02 MAP	Rectangular Table	29" x 74-3/4" x 32-3/4"	130	\$3,090	\$2,887	
	59W-144-S00 MAP	59W-144-S02 MAP	Rectangular Table	29" x 62-3/4" x 38-3/4"	110	\$3,051	\$2,836	
	59W-138-S00 MAP	59W-138-S02 MAP	Rectangular Table	29" x 74-3/4" x 38-3/4"	130	\$3,176	\$2,970	
	59W-145-S00 MAP	59W-145-S02 MAP	Rectangular Table	29" x 74-3/4" x 50-3/4"	160	\$3,522	\$3,195	
	Six Reader Rectangular Table with Center Support Legs							
		<u>Rectangular Oak Table with Wood Legs</u>						
59W-198-S00 OAK		59W-198-S02 OAK	Rectangular Table	29" x 92-3/4" x 32-3/4"	150	\$3,958	\$3,674	
59W-146-S00 OAK		59W-146-S02 OAK	Rectangular Table	29" x 92-3/4" x 38-3/4"	150	\$4,033	\$3,750	
59W-134-S00 OAK		59W-134-S02 OAK	Rectangular Table	29" x 92-3/4" x 50-3/4"	200	\$4,478	\$4,054	
<u>Rectangular Maple Table with Wood Legs</u>								
59W-198-S00 MAP		59W-198-S02 MAP	Rectangular Table	29" x 92-3/4" x 32-3/4"	150	\$4,314	\$4,004	
59W-146-S00 MAP		59W-146-S02 MAP	Rectangular Table	29" x 92-3/4" x 38-3/4"	150	\$4,396	\$4,088	
59W-134-S00 MAP	59W-134-S02 MAP	Rectangular Table	29" x 92-3/4" x 50-3/4"	200	\$4,881	\$4,419		
Wood Wire Management Leg								
	59W-945-S00 OAK		Optional Oak Leg	29"H	12		\$378	
	59W-945-S00 MAP		Optional Maple Leg	29"H	12		\$378	

Please specify Wood Finish (Table 1), High-Pressure Laminate (Table 2) and Metal Color; if applicable (Table 3).
Details can be found on pages GEN 4 and GEN 5.

General Specifications

TABLETOPS

Tabletops are 1-3/16" thick, 3-ply 45# density particleboard core with a .050" high-pressure laminate face and a .020" thick backing sheet on the underside. High-pressure laminate has a low-glare finish resistant to scratches, fading and staining in accordance with NEMA standards. Tabletops are banded on exposed edges with a 1-3/4" thick x 2"W solid-maple external undercut chamfered edge band applied to the table core after lamination of the face plastic. The edge band is beveled down at a 20° angle with a 1/2" radius bullnose at the leading edge. Square and rectangular tabletop edge bands are mitered on all corners and receive a 1/8" radius.

LEGS (CHROME)

Legs are 2-1/2" round, 16-gauge steel tubing. The table is without an apron, with legs attached to the tabletop by a 5" square x 5/16" thick steel plate. Leg and plate are painted or plated to match the leg (see chrome specifications) and have no sharp edges. The plate is attached to the leg by a 9" x 3" x 3/8" steel angle bracket placed at a 45° angle. The steel angle bracket receives two cutout designs replicating the edge band profile. The bracket is attached to the leg plate and leg using metal to metal fasteners. The leg plate is attached to the tabletop by (5) 5/16" x 1" machine bolts engaging internally and externally threaded bushings embedded in the underside of the tabletop. Leg plates are positioned behind and hidden by the extended edge band. Edge band extends 1/2" below the tabletop. Each leg has 2-1/2"D x 1"H adjustable glide mounted into a recessed threaded insert.

LEGS (POWDER-COATED)

Legs are 2-1/2" round, 16-gauge steel tubing. The table is without an apron, with legs attached to the tabletop by a 5" square x 5/16" thick steel plate. Legs and plates are electrostatic powder-coat painted and have no sharp edges. The plate attaches to the leg by a 9" x 3" x 3/8" steel angle bracket placed at a 45° angle. The steel angle bracket receives two cutout designs replicating the edge band profile. The steel bracket is attached to the leg plate and leg using metal to metal fasteners. The strap may be electrostatic powder-coat painted or chrome plated. The leg plate is attached to the tabletop by (5) 5/16" x 1" machine bolts engaging internally and externally threaded bushings embedded in the underside of the tabletop. Leg plates are positioned behind, and hidden by the extended edge band. Edge band extends 1/2" below the tabletop. Each leg has 2-1/2"D x 1"H adjustable glide mounted into a recessed threaded insert.

PRIVACY PANEL

Privacy panels are 10"H, constructed of 1" thick, 9-ply hardwood veneer-core plywood. Exposed panel edges are banded with 1.6mm solid maple. The privacy panel attaches securely to the tabletop by screws passing through the tabletop and into the privacy panels. Privacy panel is finished to match the table edge band. Privacy panel is designed to hide computer wires and to eliminate incidental tampering.

ELECTRICAL

Tables have 3" grommets for wire passage and J-channel wire managers mounted under the table to hold excess wires. Grommets are ABS, black plastic, with notched removable cap. J-channel wire managers are 18-gauge steel with electrostatic applied black powder-coat paint.

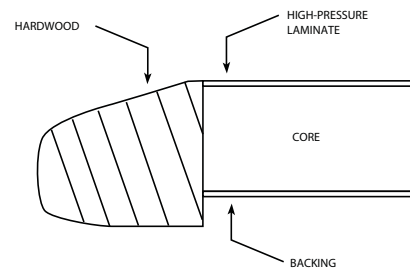

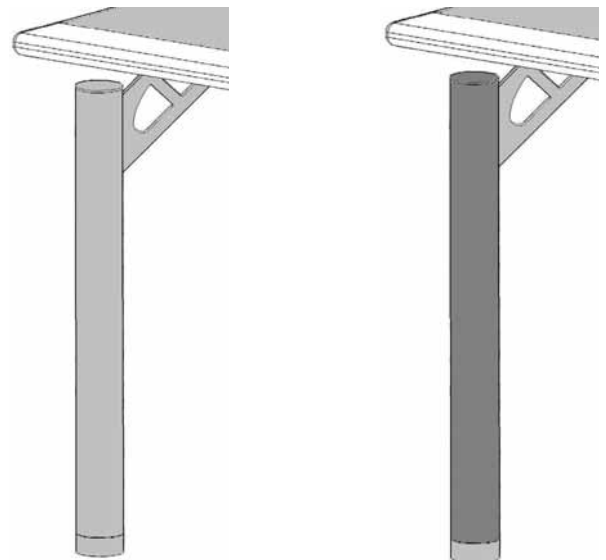

Epoch Series Edge

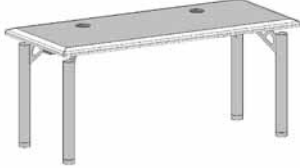

Chrome Leg

Powder-Coated Leg

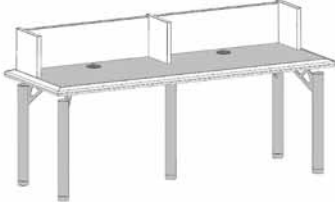
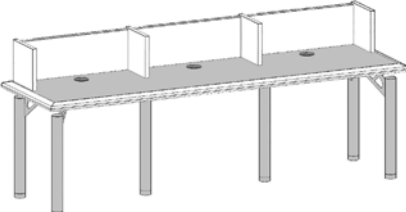
	Oak Catalog No.	Maple Catalog No.	Description	H x W x D	Wt. (lbs.)	Oak Price	Maple Price
One Position Computer Tables							
	<u>Table with Chrome Legs</u>						
	59C-645-S00 OAK	59C-645-S00 MAP	Sitting Height	27-1/2" x 32-3/4" x 26-3/4"	80	\$3,567	\$3,888
	59C-665-S00 OAK	59C-665-S00 MAP	Sitting Height	27-1/2" x 32-3/4" x 32-3/4"	80	\$3,611	\$3,937
	<u>Table with Powder-Coated Legs</u>						
	59-645-S00 OAK	59-645-S00 MAP	Sitting Height	27-1/2" x 32-3/4" x 26-3/4"	80	\$2,540	\$2,768
	59-665-S00 OAK	59-665-S00 MAP	Sitting Height	27-1/2" x 32-3/4" x 32-3/4"	80	\$2,604	\$2,838
Two Position Computer Tables							
	<u>Table with Chrome Legs</u>						
	59C-649-S00 OAK	59C-649-S00 MAP	Sitting Height	27-1/2" x 62-3/4" x 26-3/4"	110	\$4,205	\$4,583
	59C-669-S00 OAK	59C-669-S00 MAP	Sitting Height	27-1/2" x 62-3/4" x 32-3/4"	110	\$4,269	\$4,653
	<u>Table with Powder-Coated Legs</u>						
	59-649-S00 OAK	59-649-S00 MAP	Sitting Height	27-1/2" x 62-3/4" x 26-3/4"	110	\$3,445	\$3,756
	59-669-S00 OAK	59-669-S00 MAP	Sitting Height	27-1/2" x 62-3/4" x 32-3/4"	110	\$3,509	\$3,824
One Position Computer Table with 10"H Privacy Panel							
	<u>Table with Chrome Legs</u>						
	59C-643-S00 OAK	59C-643-S00 MAP	Sitting Height	27-1/2" x 38-3/4" x 26-3/4"	70	\$3,899	\$4,251
	59C-663-S00 OAK	59C-663-S00 MAP	Sitting Height	27-1/2" x 38-3/4" x 38-3/4"	70	\$3,854	\$4,201
	<u>Table with Powder-Coated Legs</u>						
	59-643-S00 OAK	59-643-S00 MAP	Sitting Height	27-1/2" x 38-3/4" x 26-3/4"	70	\$2,879	\$3,138
	59-663-S00 OAK	59-663-S00 MAP	Sitting Height	27-1/2" x 38-3/4" x 38-3/4"	70	\$2,971	\$3,238
Two Position Computer Table with 10"H Privacy Panel							
	<u>Table with Chrome Legs</u>						
	59C-642-S00 OAK	59C-642-S00 MAP	Sitting Height	27-1/2" x 74-3/4" x 26-3/4"	150	\$4,830	\$5,265
	59C-662-S00 OAK	59C-662-S00 MAP	Sitting Height	27-1/2" x 74-3/4" x 38-3/4"	150	\$5,007	\$5,457
	<u>Table with Powder-Coated Legs</u>						
	59-642-S00 OAK	59-642-S00 MAP	Sitting Height	27-1/2" x 74-3/4" x 26-3/4"	150	\$3,673	\$4,003
	59-662-S00 OAK	59-662-S00 MAP	Sitting Height	27-1/2" x 74-3/4" x 38-3/4"	150	\$3,854	\$4,202
Three Position Computer Table with 10"H Privacy Panel							
	<u>Table with Chrome Legs</u>						
	59C-644-S00 OAK	59C-644-S00 MAP	Sitting Height	27-1/2" x 92-3/4" x 26-3/4"	180	\$5,844	\$6,370
	59C-664-S00 OAK	59C-664-S00 MAP	Sitting Height	27-1/2" x 92-3/4" x 38-3/4"	180	\$6,068	\$6,614
	<u>Table with Powder-Coated Legs</u>						
	59-644-S00 OAK	59-644-S00 MAP	Sitting Height	27-1/2" x 92-3/4" x 26-3/4"	180	\$4,553	\$4,963
	59-664-S00 OAK	59-664-S00 MAP	Sitting Height	27-1/2" x 92-3/4" x 38-3/4"	180	\$4,774	\$5,203

Please specify Wood Finish (Table 1), High-Pressure Laminate (Table 2) and Metal Color; if applicable (Table 3). Details can be found on pages GEN 4 and GEN 5.

General Specifications

TABLETOPS

Tabletops are 1-3/16" thick, 3-ply 45# density particleboard, with a .050" thick high-pressure laminate top surface and a .020" thick backing sheet for balanced construction. Top receives a 2" x 1-3/4" thick external solid drop edge band of Northern-grown Red Oak or maple. Edge band is beveled down at a 20° angle with a 1/2" bullnose leading edge. Square and rectangular tabletop edge bands are mitered at all four corners and radius 1/8".

LEG (METAL)

Legs are 2-1/2" round 16-gauge cold-rolled steel tubing. Legs receive a 9" x 3" x 1/2" cold-rolled steel angle bracket placed at a 45° angle that is attached to a 5" square x 5/16" thick cold-rolled steel plate for connection to the tabletop. Legs are attached to the leg plate and bracket using metal to metal fasteners. The steel angle bracket receives two cutout designs replicating the edge band profile. The leg plate is attached to the tabletop by five 5/16" x 1" machine bolts engaging internal and external threaded bushings embedded in the underside of the tabletop. Leg plates are positioned behind and hidden by the drop edge band. Edge band extends 1/2" below the tabletop. Each leg receives a 2-1/2"D x 1"H adjustable glide mounted in a recessed threaded insert. Leg and plate are painted or plated to match (see chrome specifications) and have no sharp edges.

LEG (WOOD)

Legs are 2-1/2" round, glued up solid Northern-grown Red Oak or maple. Legs receive a 9" x 3" x 1/2" cold-rolled steel angle bracket placed at a 45° angle that is attached to a 5" square x 5/16" thick cold-rolled steel plate for connection to the tabletop. Legs are attached to the leg plate and bracket using metal to metal fasteners. The steel angle bracket receives two cutout designs replicating the edge band profile. The leg plate is attached to the tabletop by five 5/16" x 1" machine bolts engaging internal and external threaded bushings embedded in the underside of the tabletop. Leg plates are positioned behind and hidden by the drop edge band. Edge band extends 1/2" below the tabletop. Each leg receives a 2-1/2"D x 1"H adjustable glide mounted in a recessed threaded insert. Leg and plate are painted or plated to match (see chrome specifications) and have no sharp edges.

Note: Angle Bracket and Glide can be individually chrome plated (see chrome specifications) or painted any of Brodart's powder-coat paints as specified.

LEG (WIRE MANAGEMENT)

When specified, a wire management leg will be provided. This leg has a 1/2" wide slot located in the back of the leg underneath the angle support bracket, 3/8" down from the top of the leg and 3-3/8" from the bottom of the leg. A spring loaded cover of 1/8" bent metal and finished to match the leg is _____. The cover allows for a 1" egress at the top and bottom of the slot for cords.

CHROME PLATING SPECIFICATION

Where chrome plating is specified, Brodart provides a decorative chrome electro-plated finish that protects against tarnish and minimizes scratching. Brodart Class AA chrome plating requires a .004" to .005" thick layer of bright nickel and a layer of chromium to produce a high-quality furniture-grade finish.

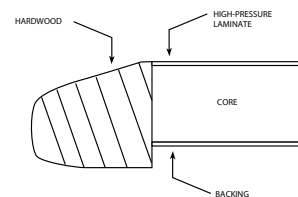

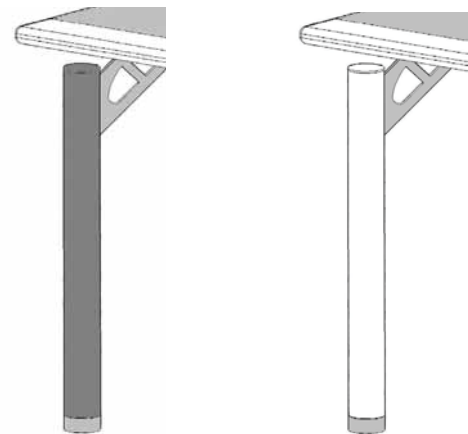

Epoch Series Edge



Powder-Coated Leg

Wood Leg

Oak Catalog No.	Maple Catalog No.	Description	H x W x D	Wt. (lbs.)	Oak Price	Maple Price	
<i>Table with Powder-Coat Painted Metal Legs</i>							 <p>ISO Tables Starter</p>
590CIGS29AEPMS	59MCIGS29AEPMS	Standing Height Starter	29" x 42-11/16" x 30-1/2"	80	\$5,169	\$5,531	
590CIGA29AEPMS	59MCIGA29AEPMS	Standing Height Adder	29" x 42-11/16" x 30-1/2"	70	\$3,503	\$3,748	
590CIGS27AEPMS	59MCIGS27AEPMS	Sitting Height Starter	27-1/2" x 42-11/16" x 30-1/2"	80	\$5,169	\$5,531	
590CIGA27AEPMS	59MCIGA27AEPMS	Sitting Height Adder	27-1/2" x 42-11/16" x 30-1/2"	70	\$3,503	\$3,748	
<i>Table with Wood Legs</i>							 <p>Adder</p>
590CIGS29AEWMS	59MCIGS29AEWMS	Standing Height Starter	29" x 42-11/16" x 30-1/2"	80	\$4,910	\$5,254	
590CIGA29AEWMS	59MCIGA29AEWMS	Standing Height Adder	29" x 42-11/16" x 30-1/2"	70	\$3,374	\$3,610	
590CIGS27AEWMS	59MCIGS27AEWMS	Sitting Height Starter	27-1/2" x 42-11/16" x 30-1/2"	80	\$4,910	\$5,254	
590CIGA27AEWMS	59MCIGA27AEWMS	Sitting Height Adder	27-1/2" x 42-11/16" x 30-1/2"	70	\$3,374	\$3,610	

Note: For electrical and wire management options for the products listed above, please refer to the Electrical Accessories section of this price list.

Please specify Wood Finish (Table 1), High-Pressure Laminate (Table 2) and Metal Color; if applicable (Table 3). Details can be found on pages GEN 4 and GEN 5.

General Specifications

TABLETOPS

Table tops are 1-3/16" thick, 3-ply 45# density particleboard, with plain-sliced slip matched Northern-grown Red Oak or Maple veneer on both sides. Top receives a 2" x 1-3/4" thick external drop edge band of solid Northern-grown Red Oak or Maple. The band is beveled down at a 20° angle with a 1/2" bullnose leading edge. Square and rectangular tabletop edge bands are mitered at all four corners and radius 1/8".

Note: Tops for tables 96" and smaller will receive the grain of the veneer running in the "long" direction. Tops for tables 96" and longer will receive the grain running in the "short" direction.

BASE – WOOD

The base consists of a top and bottom horizontal stretcher connected by a vertical panel. The top and bottom horizontal pieces will be solid Northern-grown Red Oak or Maple. The vertical panel will be 1-3/16" thick, 3-ply 45# density particleboard, with plain-sliced slip matched Northern-grown Red Oak or Maple veneer on both sides. The upper horizontal part of the each base will receive borings for attaching the assembly to the table top. The lower horizontal piece will receive a 1-1/2" diameter, adjustable glide mounted in a recessed tee-nut which is further recessed into the leg by means of a counter-sink boring which accepts the upper two-thirds of the glide. Table tops are attached to base by bolting through the upper horizontal members of base into internal and external threaded bushings embedded in the underside of the table top.

The assembled base components will connect to each other via two horizontal rails. Rails will be constructed of 1-3/16" thick, 3-ply 45# density particleboard, with plain-sliced slip matched Northern-grown Red Oak or Maple veneer on both sides and attach to base and also provide support for the tabletop.

BASE – WOOD & METAL

The wood and metal base construction is the same as the standard wood base with the addition of two 2-1/2" round 16-gauge cold-rolled steel tubing fitted between the pedestal top and bottom rails. Tubing will be Legs will be finished with electrostatic applied epoxy powder-coat paint.

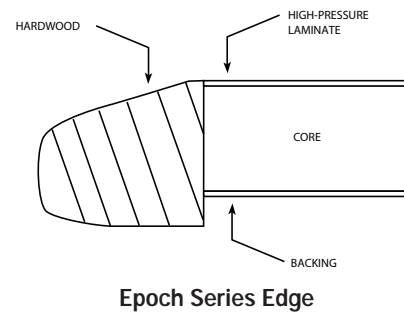

Oak Catalog No.	Maple Catalog No.	Description	H x W x D	Wt. (lbs.)	Oak Price	Maple Price	
590CON367229WPDS	59MCON367229WPDS	Two Pedestal Base	29" x 72" x 36"	125	\$7,360	\$7,968	Two Pedestal Base
590CON489629WPDS	59MCON489629WPDS	Two Pedestal Base	29" x 96" x 48"	190	\$12,942	\$14,116	

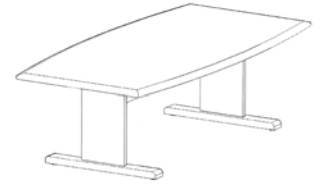

590CON5414429WPDS	59MCON5414429WPDS	Three Pedestal Base	29" x 144" x 54"	350	\$22,074	\$24,063	Three Pedestal Base
590CON5418029WPDS	59MCON5418029WPDS	Three Pedestal Base	29" x 180" x 54"	410	\$23,434	\$25,556	

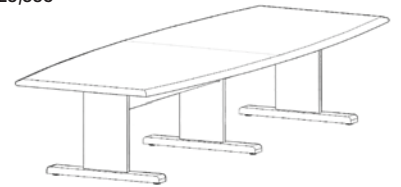

590CON5424029WPDS	59MCON5424029WPDS	Four Pedestal Base	29" x 240" x 54"	550	\$29,905	\$32,624	Four Pedestal Base
-------------------	-------------------	--------------------	------------------	-----	----------	----------	--------------------

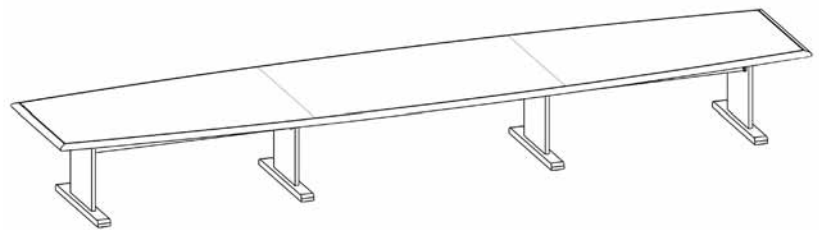

Please specify Wood Finish (Table 1), High-Pressure Laminate (Table 2) and Metal Color (Table 3). Details can be found on pages GEN 4 and GEN 5.

The Epoch Collection

Conference Tables, Wood and Metal Base

	Oak Catalog No.	Maple Catalog No.	Description	H x W x D	Wt. (lbs.)	Oak Price	Maple Price
Two Pedestal Base	590CON367229WMPS	59MCON367229WMPS	Two Pedestal Base	29" x 72" x 36"	125	\$7,905	\$8,513
	590CON489629WMPS	59MCON489629WMPS	Two Pedestal Base	29" x 96" x 48"	190	\$13,492	\$14,661

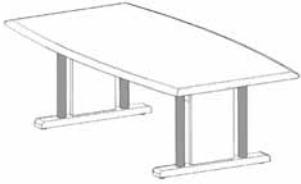

Three Pedestal Base	590CON5414429WMPS	59MCON5414429WMPS	Three Pedestal Base	29" x 144" x 54"	350	\$22,889	\$24,878
	590CON5418029WMPS	59MCON5418029WMPS	Three Pedestal Base	29" x 180" x 54"	410	\$24,254	\$26,381

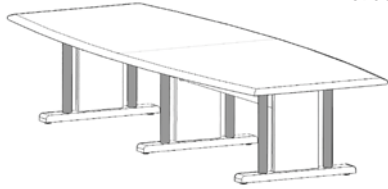

Four Pedestal Base	590CON5424029WMPS	59MCON5424029WMPS	Four Pedestal Base	29" x 240" x 54"	550	\$31,005	\$33,704
---------------------------	-------------------	-------------------	--------------------	------------------	-----	----------	----------

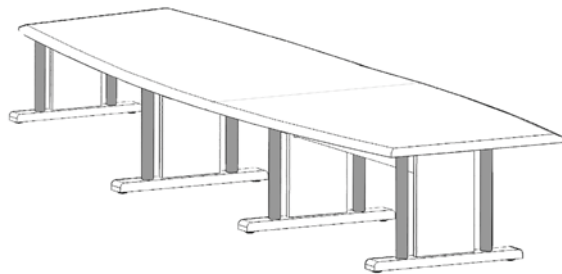

Please specify Wood Finish (Table 1), High-Pressure Laminate (Table 2) and Metal Color (Table 3). Details can be found on pages GEN 4 and GEN 5.

General Specifications

WORKSTATIONS

Workstations are designed in a modular starter/adder configuration and available in single or double-face system. The workstation top is 36" or 47-5/8"W x 28-1/2"D. A 1-1/2"W cord drop runs the width of the carrel between work surface and back panel to allow passage of electrical cords. The workstation support shelf is 8"D. End and intermediate panels are 47-1/2"H and 33-1/8"D. The work surface attaches to end and intermediate panel by (2) metal "Z" brackets with 5/16" - 18 hex-head bolts engaging internally and externally threaded bushings embedded into panels. The back panel is attached to end and intermediate panel using hidden metal keyway attachments. The workstation support shelf is attached to end, intermediate and back panels with 3/4" x 3/4" black steel angle brackets and black #8 screws.

WORKSTATION TOP

The workstation top is 1-3/16" thick, 45# density particleboard core with a top surface of .050" thick high-pressure laminate and .020" thick phenolic backing sheet for balanced construction. High-pressure laminate has a low-glare finish resistant to scratches, fading and staining in accordance with NEMA standards. The exposed edge is banded with a 2"W x 1-3/4" thick solid hard maple external chamfered edge band laminated to the work surface core after lamination of the face plastic. The edge band is beveled at a 20° angle with a 1/2" radius bullnose at the leading edge. The back edge of the top has a black plastic strap 1-1/2"W that projects above the work surface 1/4" to act as a retainer. All work surfaces are 29"H.

END AND INTERMEDIATE PANELS

End and intermediate panels are 1-3/16" thick, 3-ply 45# particleboard core select plain-sliced, slip-matched maple veneer. Vertical and top edges of the end and intermediate panel have 1.6mm thick maple edge band. Each panel has two 1-1/4" diameter chrome adjustable glides. Starter end panels have an arched window inserted 3-1/4" down from the center of the top edge of the panel. The 3-form is 4"H x 16"W and is held in place with 1/4" thick maple molding on both sides of the window (see window specifications). The molding is sanded flush with the panel surfaces. End panels have a 1/4" x 1/4" x 3/16" square rod embedded 4" up from the bottom edge. The square rod can be chrome plated or powder coated as ordered (see chrome specs).

BACK PANEL

The back panel is 3/4" thick 3-ply 45# density particleboard core with plain-sliced slip matched maple veneer on both faces. The top and bottom edges have 1.6mm maple edge banding. The back panel is attached the end or intermediate panel using metal keyway attachments.

WORKSTATION SUPPORT SHELF

The workstation support is 3/4" thick, 45# density particleboard core with select AA slip-matched maple veneer. The support has a 3/4" thick solid maple external band on the exposed edge. The support is located under the work surface and extends the full width of the workstation.

CHROME PLATING SPECIFICATION



Where "chrome plated" is specified, Brodart provides a decorative chromium electro-plated finish that protects against tarnish and minimizes scratching. Brodart Class AA chrome plating requires a .004" to .005" thick layer of bright nickel and a layer of chromium to produce a high-quality furniture grade finish.

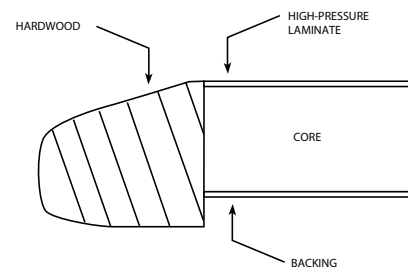

WINDOW SPECIFICATIONS



Unless otherwise specified all resin window panels are 1/4" thick. Customers must specify the color they require from those offered by Brodart. The resin window is held in place by 1/4" thick solid wood maple molding, on both sides of the window. The molding is sanded flush with the panel surfaces.





Epoch Series Edge

	Oak Catalog No.	Maple Catalog No.	Description	H x W x D	Wt. (lbs.)	Oak Price	Maple Price
 Starter	<u>36" Wide Working Space</u>						
	59GP-673-S00 OAK	59GP-673-S00 MAP	S/F Starter	47-1/2" x 38-1/4" x 33"	165	\$5,050	\$5,505
 Adder	<u>36" Wide Working Space</u>						
	59-672-S00 OAK	59-672-S00 MAP	S/F Adder	47-1/2" x 37-1/4" x 33"	115	\$2,311	\$2,519
	<u>48" Wide Working Space</u>						
	59GP-460-S00 OAK	59GP-460-S00 MAP	S/F Starter	47-1/2" x 50" x 33"	195	\$5,230	\$5,701
	59-459-S00 OAK	59-459-S00 MAP	S/F Adder	47-1/2" x 48-3/4" x 33"	145	\$2,491	\$2,715

	Oak Catalog No.	Maple Catalog No.	Description	H x W x D	Wt. (lbs.)	Oak Price	Maple Price
 Starter	<u>36" Wide Working Space</u>						
	59GC-673-S00 OAK	59GC-673-S00 MAP	S/F Starter	47-1/2" x 38-1/4" x 33"	165	\$5,878	\$6,407
 Adder	<u>36" Wide Working Space</u>						
	59-672-S00 OAK	59-672-S00 MAP	S/F Adder	47-1/2" x 37-1/4" x 33"	115	\$2,311	\$2,519
	<u>48" Wide Working Space</u>						
	59GC-460-S00 OAK	59GC-460-S00 MAP	S/F Starter	47-1/2" x 50" x 33"	195	\$6,089	\$6,637
	59-459-S00 OAK	59-459-S00 MAP	S/F Adder	47-1/2" x 48-3/4" x 33"	145	\$2,491	\$2,715

	Oak Catalog No.	Maple Catalog No.	Description	H x W x D	Wt. (lbs.)	Oak Price	Maple Price
 Starter	<u>36" Wide Working Space</u>						
	59TP-673-S00 OAK	59TP-673-S00 MAP	S/F Starter	47-1/2" x 38-1/4" x 33"	165	\$4,292	\$4,678
 Adder	<u>36" Wide Working Space</u>						
	59-672-S00 OAK	59-672-S00 MAP	S/F Adder	47-1/2" x 37-1/4" x 33"	115	\$2,311	\$2,519
	<u>48" Wide Working Space</u>						
	59TP-460-S00 OAK	59TP-460-S00 MAP	S/F Starter	47-1/2" x 50" x 33"	195	\$4,444	\$4,844
	59-459-S00 OAK	59-459-S00 MAP	S/F Adder	47-1/2" x 48-3/4" x 33"	145	\$2,491	\$2,715

	Oak Catalog No.	Maple Catalog No.	Description	H x W x D	Wt. (lbs.)	Oak Price	Maple Price
 Starter	<u>36" Wide Working Space</u>						
	59TC-673-S00 OAK	59TC-673-S00 MAP	S/F Starter	47-1/2" x 38-1/4" x 33"	165	\$5,171	\$5,636
 Adder	<u>36" Wide Working Space</u>						
	59-672-S00 OAK	59-672-S00 MAP	S/F Adder	47-1/2" x 37-1/4" x 33"	115	\$2,311	\$2,519
	<u>48" Wide Working Space</u>						
	59TC-460-S00 OAK	59TC-460-S00 MAP	S/F Starter	47-1/2" x 50" x 33"	195	\$5,355	\$5,837
	59-459-S00 OAK	59-459-S00 MAP	S/F Adder	47-1/2" x 48-3/4" x 33"	145	\$2,491	\$2,715

Please specify Wood Finish (Table 1), High-Pressure Laminate (Table 2), Metal Color (Table 3) and Resin Option; if applicable (Table 6). Details can be found on pages GEN 4, GEN 5 and GEN 6.

Oak Catalog No.	Maple Catalog No.	Description	H x W x D	Wt. (lbs.)	Oak Price	Maple Price
-----------------	-------------------	-------------	-----------	------------	-----------	-------------

36" Wide Working Space

59GP-674-S00 OAK	59GP-674-S00 MAP	D/F Starter	47-1/2" x 38-1/4" x 66-1/4"	306	\$9,781	\$10,661
59-675-S00 OAK	59-675-S00 MAP	D/F Adder	47-1/2" x 37-1/4" x 66-1/4"	205	\$4,809	\$5,241

48" Wide Working Space

59GP-461-S00 OAK	59GP-461-S00 MAP	D/F Starter	47-1/2" x 50" x 66-1/4"	366	\$10,333	\$11,262
59-462-S00 OAK	59-462-S00 MAP	D/F Adder	47-1/2" x 48-3/4" x 66-1/4"	265	\$4,724	\$5,149

Information Access Workstations/Carrels with Resin Window and Painted Accent

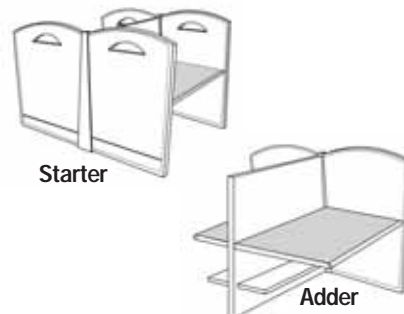

36" Wide Working Space

59GC-674-S00 OAK	59GC-674-S00 MAP	D/F Starter	47-1/2" x 38-1/4" x 66-1/4"	165	\$11,389	\$12,414
59-675-S00 OAK	59-675-S00 MAP	D/F Adder	47-1/2" x 37-1/4" x 66-1/4"	205	\$4,809	\$5,241

48" Wide Working Space

59GC-461-S00 OAK	59GC-461-S00 MAP	D/F Starter	47-1/2" x 50" x 66-1/4"	195	\$12,030	\$13,113
59-462-S00 OAK	59-462-S00 MAP	D/F Adder	47-1/2" x 48-3/4" x 66-1/4"	265	\$4,724	\$5,149

Information Access Workstations/Carrels with Resin Window and Chrome Accent

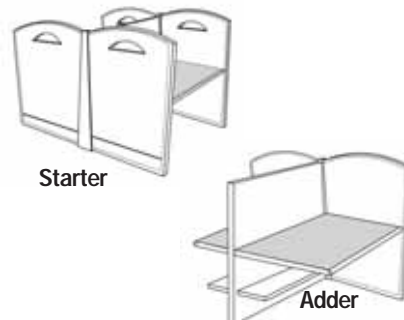

36" Wide Working Space

59TP-674-S00 OAK	59TP-674-S00 MAP	D/F Starter	47-1/2" x 38-1/4" x 66-1/4"	165	\$8,312	\$9,060
59-675-S00 OAK	59-675-S00 MAP	D/F Adder	47-1/2" x 37-1/4" x 66-1/4"	205	\$4,809	\$5,241

48" Wide Working Space

59TP-461-S00 OAK	59TP-461-S00 MAP	D/F Starter	47-1/2" x 50" x 66-1/4"	195	\$8,782	\$9,572
59-462-S00 OAK	59-462-S00 MAP	D/F Adder	47-1/2" x 48-3/4" x 66-1/4"	265	\$4,724	\$5,149

Information Access Workstations/Carrels with Painted Metal "T" Accent

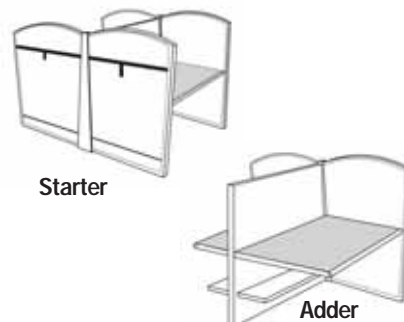

36" Wide Working Space

59TC-674-S00 OAK	59TC-674-S00 MAP	D/F Starter	47-1/2" x 38-1/4" x 66-1/4"	165	\$10,015	\$10,916
59-675-S00 OAK	59-675-S00 MAP	D/F Adder	47-1/2" x 37-1/4" x 66-1/4"	205	\$4,809	\$5,241

48" Wide Working Space

59TC-461-S00 OAK	59TC-461-S00 MAP	D/F Starter	47-1/2" x 50" x 66-1/4"	195	\$10,581	\$11,533
59-462-S00 OAK	59-462-S00 MAP	D/F Adder	47-1/2" x 48-3/4" x 66-1/4"	265	\$4,724	\$5,149

Information Access Workstations/Carrels with Chrome Metal "T" Accent

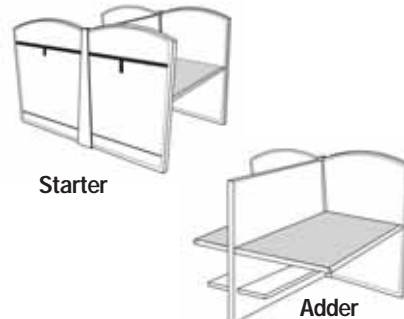

Please specify Wood Finish (Table 1), High-Pressure Laminate (Table 2), Metal Color (Table 3) and Resin Option; if applicable (Table 6). Details can be found on pages GEN 4, GEN 5 and GEN 6.

General Specifications

WORKSTATIONS

Workstations are of modular starter and adder design, with overall height 37". Workstations are available in 36", 48", 72", 96" and 108" width. A knee-space panel located below the work surface supports all work surfaces greater than 48"W. Work surface height is 27-1/2". Work surface depth is 27-3/16" with an additional 1-1/2"W cord drop between the work surface and back panel to allow passage of electrical cords. Work surface is attached to end and intermediate panels by means of two metal 22-1/2" long "Z" brackets with 5/16" - 18 hex-head bolts engaging internally and externally threaded bushings embedded in the panels. The back panel is attached to end and intermediate panels using hidden metal keyways and shoulder screws. The shelf is attached to end and intermediate panels and back panels with 3/4" x 3/4" steel, black-painted angle brackets and black #8 screws.

WORK SURFACE

Standard work surface is 1-3/16" thick, 3-ply, 45# density particleboard, including a top surface of .050" thick, high-pressure laminate, with a backing sheet not less than .020" thickness for balanced construction. High-pressure laminate has a low-glare finish resistant to scratches, fading, staining, etc. High-pressure laminate meets or exceeds NEMA standards. Front edge of work surface has a 2" x 1-3/4" solid maple edge band in a beveled bullnose shape, the same as the reading tables. The back edge of the top has a black plastic strap 1-1/2"W that projects above the work surface 1/4" to act as a retainer.

END AND INTERMEDIATE PANELS

End and intermediate panels are 1-3/16" thick, 45# density particleboard core with select face veneers of maple. All edges are banded with a 1.6mm edge band. The end panels have an accent window 8-1/2"W x 3-3/4"H (see window specs). They have a 1/4" x 1/4" square rod embedded 3/16"D up 4" from the bottom edge and chrome plated or powder coated as ordered (see chrome specs). Intermediate panels have a 3" diameter grommet below the work surface to allow passage of electrical and data wires. Each panel has two 1-1/4" adjustable glides.

BACK PANEL

Back panel is 3/4" thick, 45# density particleboard core with face veneers of select maple. The top and bottom edges of the back panel have 1.6mm thick solid maple edge bands. Back panels attach to end and intermediate panels by recessed metal fasteners and shoulder screws. The back panel on double-faced units has a 3" diameter grommet below the work surface to allow passage of electrical and data wires.

SHELF

Shelf is 3/4" thick x 8" D 45# density particleboard core with face veneers of select maple. Shelf is banded on the front edge with a 1.6 mm solid maple band. It attaches to end and intermediate panels by a pair of metal "L" brackets. Back corners of shelf have a 3" x 3" cutout to allow for the passage of electrical cords. The shelf is positioned 10" below the bottom of the work surface.

WIRE MANAGEMENT DOOR

The wire management door, positioned between the bottom of the work surface and the shelf, is designed to form a concealed wire management channel 8-1/2" H x 9-1/2" D. The door is 1/4" thick with select maple face veneers. The door slides in two aluminum tracks, one attaches to the bottom of the work surface while the other attaches to the top of the shelf.

KNEE-SPACE PANEL

All 72" and 96" W workstations, as well as functional corner units, have a knee-space panel under the work surface for additional work surface support. Units 108" W have two knee-space panels. The knee-space panel is 1-3/16" thick, 45# density particleboard core with select face veneers of maple. It is banded on exposed edges with a 1.6 mm solid maple band. The knee-space panel attaches to the back panel using a 1-3/4" square, solid maple post, grooved to receive the knee-space panel and back panels. Panels attach to the post using recessed metal fasteners and shoulder screws. The knee-space panel is angled in the back to create a space to allow passage of electrical and data cords. The knee-space panel has two 1-1/4" diameter black adjustable glides.

CHROME PLATING SPECIFICATION







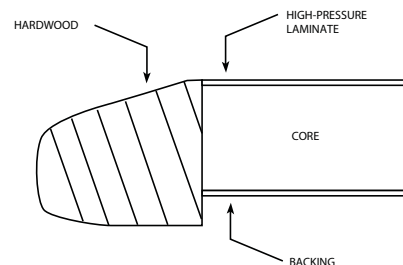

Where "chrome plated" is specified, Brodart uses a decorative chromium electro-plated finish that protects against tarnish and minimizes scratching. Brodart Class AA chrome plating requires a .004" to .005" thick layer of bright nickel and a layer of chromium to produce a high-quality furniture grade finish.

WINDOW SPECIFICATIONS

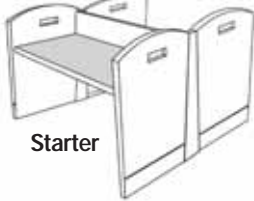
Unless otherwise specified, all resin window panels are 1/4" thick resin material. Customers must specify the color they require from those offered by Brodart. The resin window is held in place by 1/4" thick solid wood maple molding, on both sides of the resin. The molding is sanded flush with the panel surfaces.

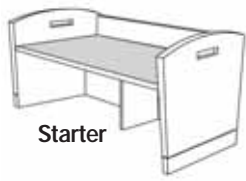









Epoch Series Edge

Oak Catalog No.	Maple Catalog No.	Description	H x W x D	Wt. (lbs.)	Oak Price	Maple Price	
<u>36" Wide Working Space</u>							Single-Faced One-Position 
59GP-S31-SS0 OAK	59GP-S31-SS0 MAP	One-Position S/F Starter with Resin Window and Painted Accent	37" x 37-1/2" x 33-1/4"	130	\$3,451	\$3,762	
59GC-S31-SS0 OAK	59GC-S31-SS0 MAP	One-Position S/F Starter with Resin Window and Chrome Accent	37" x 37-1/2" x 33-1/4"	130	\$4,002	\$4,362	
59-S31-SAO OAK	59-S31-SAO MAP	One-Position S/F Adder	37" x 36-1/2" x 33-1/4"	100	\$2,312	\$2,520	Starter
<u>48" Wide Working Space</u>							Adder 
59GP-S41-SS0 OAK	59GP-S41-SS0 MAP	One-Position S/F Starter with Resin Window and Painted Accent	37" x 49-1/4" x 33-1/4"	155	\$3,635	\$3,962	
59GC-S41-SS0 OAK	59GC-S41-SS0 MAP	One-Position S/F Starter with Resin Window and Chrome Accent	37" x 49-1/4" x 33-1/4"	155	\$4,217	\$4,597	
59-S41-SAO OAK	59-S41-SAO MAP	One-Position S/F Adder	37" x 48" x 33-1/4"	125	\$2,378	\$2,592	
<u>36" Wide Working Space</u>							Double-Faced One-Position 
59GP-D31-SS0 OAK	59GP-D31-SS0 MAP	One-Position D/F Starter with Resin Window and Painted Accent	37" x 37-1/2" x 63-1/2"	155	\$5,166	\$5,631	
59GC-D31-SS0 OAK	59GC-D31-SS0 MAP	One-Position D/F Starter with Resin Window and Chrome Accent	37" x 37-1/2" x 63-1/2"	155	\$5,993	\$6,532	
59-D31-SAO OAK	59-D31-SAO MAP	One-Position D/F Adder	37" x 37-1/2" x 63-1/2"	155	\$3,705	\$4,038	Starter
<u>48" Wide Working Space</u>							Adder 
59GP-D41-SS0 OAK	59GP-D41-SS0 MAP	One-Position D/F Starter with Resin Window and Painted Accent	37" x 49-1/4" x 63-1/2"	195	\$5,474	\$5,966	
59GC-D41-SS0 OAK	59GC-D41-SS0 MAP	One-Position D/F Starter with Resin Window and Chrome Accent	37" x 49-1/4" x 63-1/2"	195	\$6,350	\$6,922	
59-D41-SAO OAK	59-D41-SAO MAP	One-Position D/F Adder	37" x 48" x 63-1/2"	195	\$3,568	\$3,889	
<u>36" Wide Working Space</u>							Single-Faced Two-Position 
59GP-S32-SS0 OAK	59GP-S32-SS0 MAP	Two-Position S/F Starter with Resin Window and Painted Accent	37" x 74" x 33-1/4"	195	\$4,557	\$4,967	
59GC-S32-SS0 OAK	59GC-S32-SS0 MAP	Two-Position S/F Starter with Resin Window and Chrome Accent	37" x 74" x 33-1/4"	195	\$5,285	\$5,761	
59-S32-SAO OAK	59-S32-SAO MAP	Two-Position S/F Adder	37" x 73" x 33-1/4"	165	\$3,435	\$3,744	Starter
<u>48" Wide Working Space</u>							Adder 
59GP-S42-SS0 OAK	59GP-S42-SS0 MAP	Two-Position S/F Starter with Resin Window and Painted Accent	37" x 97-1/4" x 33-1/4"	235	\$4,864	\$5,302	
59GC-S42-SS0 OAK	59GC-S42-SS0 MAP	Two-Position S/F Starter with Resin Window and Chrome Accent	37" x 97-1/4" x 33-1/4"	235	\$5,641	\$6,148	
59-S42-SAO OAK	59-S42-SAO MAP	Two-Position S/F Adder	37" x 96" x 33-1/4"	205	\$3,614	\$3,940	
<u>36" Wide Working Space</u>							Double-Faced Two-Position 
59GP-D32-SS0 OAK	59GP-D32-SS0 MAP	Two-Position D/F Starter with Resin Window and Painted Accent	37" x 74" x 63-1/2"	330	\$6,867	\$7,485	
59GC-D32-SS0 OAK	59GC-D32-SS0 MAP	Two-Position D/F Starter with Resin Window and Painted Accent	37" x 74" x 63-1/2"	330	\$7,966	\$8,683	
59-D32-SAO OAK	59-D32-SAO MAP	Two-Position D/F Adder	37" x 73" x 63-1/2"	270	\$5,487	\$5,981	Starter
<u>48" Wide Working Space</u>							Adder 
59GP-D42-SS0 OAK	59GP-D42-SS0 MAP	Two-Position D/F Starter with Resin Window and Painted Accent	37" x 97-1/4" x 63-1/2"	355	\$7,087	\$7,725	
59GC-D42-SS0 OAK	59GC-D42-SS0 MAP	Two-Position D/F Starter with Resin Window and Chrome Accent	37" x 97-1/4" x 63-1/2"	355	\$8,222	\$8,962	
59-D42-SAO OAK	59-D42-SAO MAP	Two-Position D/F Adder	37" x 96" x 63-1/2"	355	\$5,424	\$5,912	

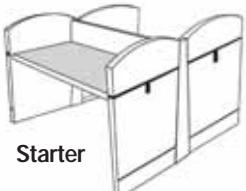
Please specify Wood Finish (Table 1), High-Pressure Laminate (Table 2), Metal Color (Table 3) and Resin Option; if applicable (Table 6). Details can be found on pages GEN 4, GEN 5 and GEN 6.

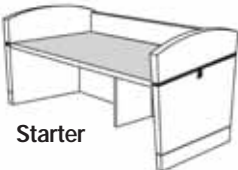
The Epoch Collection

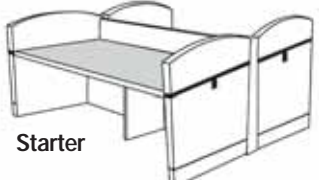
Modular Media Stations with Metal "T" Accent

	Oak Catalog No.	Maple Catalog No.	Description	H x W x D	Wt. (lbs.)	Oak Price	Maple Price
Single-Faced One-Position							
<u>36" Wide Working Space</u>							
 Starter	59TP-S31-SS0 OAK	59TP-S31-SS0 MAP	One-Position S/F Starter with Painted Metal "T" Accent	37" x 37-1/2" x 33-1/4"	130	\$2,932	\$3,196
	59TC-S31-SS0 OAK	59TC-S31-SS0 MAP	One-Position S/F Starter with Chrome "T" Accent	37" x 37-1/2" x 33-1/4"	130	\$3,555	\$3,875
	59-S31-SAO OAK	59-S31-SAO MAP	One-Position S/F Adder	37" x 36-1/2" x 33-1/4"	100	\$2,312	\$2,520
 Adder	<u>48" Wide Working Space</u>						
	59TP-S41-SS0 OAK	59TP-S41-SS0 MAP	One-Position S/F Starter with Painted Metal "T" Accent	37" x 49-1/4" x 33-1/4"	155	\$3,089	\$3,367
	59TC-S41-SS0 OAK	59TC-S41-SS0 MAP	One-Position S/F Starter with Chrome "T" Accent	37" x 49-1/4" x 33-1/4"	155	\$3,744	\$4,080
	59-S41-SAO OAK	59-S41-SAO MAP	One-Position S/F Adder	37" x 48" x 33-1/4"	125	\$2,378	\$2,592
Double-Faced One-Position							
<u>36" Wide Working Space</u>							
 Starter	59TP-D31-SS0 OAK	59TP-D31-SS0 MAP	One-Position D/F Starter with Painted Metal "T" Accent	37" x 37-1/2" x 63-1/2"	155	\$4,391	\$4,786
	59TC-D31-SS0 OAK	59TC-D31-SS0 MAP	One-Position D/F Starter with Chrome "T" Accent	37" x 37-1/2" x 63-1/2"	155	\$5,321	\$5,801
	59-D31-SAO OAK	59-D31-SAO MAP	One-Position D/F Adder	37" x 37-1/2" x 63-1/2"	155	\$3,705	\$4,038
 Adder	<u>48" Wide Working Space</u>						
	59TP-D41-SS0 OAK	59TP-D41-SS0 MAP	One-Position D/F Starter with Painted Metal "T" Accent	37" x 49-1/4" x 63-1/2"	195	\$4,654	\$5,073
	59TC-D41-SS0 OAK	59TC-D41-SS0 MAP	One-Position D/F Starter with Chrome "T" Accent	37" x 49-1/4" x 63-1/2"	195	\$5,638	\$6,145
	59-D41-SAO OAK	59-D41-SAO MAP	One-Position D/F Adder	37" x 48" x 63-1/2"	195	\$3,568	\$3,889
Single-Faced Two-Position							
<u>36" Wide Working Space</u>							
 Starter	59TP-S32-SS0 OAK	59TP-S32-SS0 MAP	Two-Position S/F Starter with Painted Metal "T" Accent	37" x 74" x 33-1/4"	195	\$3,874	\$4,222
	59TC-S32-SS0 OAK	59TC-S32-SS0 MAP	Two-Position S/F Starter with Chrome "T" Accent	37" x 74" x 33-1/4"	195	\$4,694	\$5,116
	59-S32-SAO OAK	59-S32-SAO MAP	Two-Position S/F Adder	37" x 73" x 33-1/4"	165	\$3,435	\$3,744
 Adder	<u>48" Wide Working Space</u>						
	59TP-S42-SS0 OAK	59TP-S42-SS0 MAP	Two-Position S/F Starter with Painted Metal "T" Accent	37" x 97-1/4" x 33-1/4"	235	\$4,133	\$4,505
	59TC-S42-SS0 OAK	59TC-S42-SS0 MAP	Two-Position S/F Starter with Chrome "T" Accent	37" x 97-1/4" x 33-1/4"	235	\$5,008	\$5,459
	59-S42-SAO OAK	59-S42-SAO MAP	Two-Position S/F Adder	37" x 96" x 33-1/4"	205	\$3,614	\$3,940
Double-Faced Two-Position							
<u>36" Wide Working Space</u>							
 Starter	59TP-D32-SS0 OAK	59TP-D32-SS0 MAP	Two-Position D/F Starter with Painted Metal "T" Accent	37" x 74" x 63-1/2"	330	\$5,837	\$6,362
	59TC-D32-SS0 OAK	59TC-D32-SS0 MAP	Two-Position D/F Starter with Chrome "T" Accent	37" x 74" x 63-1/2"	330	\$7,072	\$7,709
	59-D32-SAO OAK	59-D32-SAO MAP	Two-Position D/F Adder	37" x 73" x 63-1/2"	270	\$5,487	\$5,981
 Adder	<u>48" Wide Working Space</u>						
	59TP-D42-SS0 OAK	59TP-D42-SS0 MAP	Two-Position D/F Starter with Painted Metal "T" Accent	37" x 97-1/4" x 63-1/2"	355	\$6,024	\$6,566
	59TC-D42-SS0 OAK	59TC-D42-SS0 MAP	Two-Position D/F Starter with Chrome "T" Accent	37" x 97-1/4" x 63-1/2"	355	\$7,299	\$7,957
	59-D42-SAO OAK	59-D42-SAO MAP	Two-Position D/F Adder	37" x 96" x 63-1/2"	355	\$5,424	\$5,912

Please specify Wood Finish (Table 1), High-Pressure Laminate (Table 2) and Metal Color (Table 3). Details can be found on pages GEN 4 and GEN 5.

Oak Catalog No.	Maple Catalog No.	Description	H x W x D	Wt. (lbs.)	Oak Price	Maple Price
36" Wide Working Space						
59GP-S33-SS0 OAK	59GP-S33-SS0 MAP	Three-Position S/F Starter with Resin Window and Painted Accent	37" x 110-1/2" x 33-1/4"	260	\$5,759	\$6,277
59GC-S33-SS0 OAK	59GC-S33-SS0 MAP	Three-Position S/F Starter with Resin Window and Chrome Accent	37" x 110-1/2" x 33-1/4"	260	\$6,680	\$7,281
59-S33-SAO OAK	59-S33-SAO MAP	Three-Position S/F Adder	37" x 109-1/4" x 33-1/4"	230	\$4,503	\$4,908

Single-Faced Three-Position

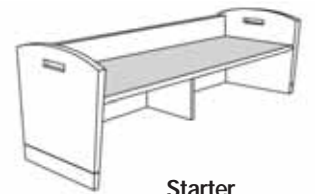

Starter



Adder

36" Wide Working Space						
59GP-D33-SS0 OAK	59GP-D33-SS0 MAP	Three-Position D/F Starter with Resin Window and Painted Accent	37" x 110-1/2" x 33-1/4"	445	\$7,432	\$8,101
59GC-D33-SS0 OAK	59GC-D33-SS0 MAP	Three-Position D/F Starter with Resin Window and Chrome Accent	37" x 110-1/2" x 33-1/4"	445	\$8,623	\$9,399
59-D33-SAO OAK	59-D33-SAO MAP	Three Position D/F Adder	37" x 109-1/4" x 33-1/4"	385	\$8,232	\$8,972

Double-Faced Three-Position



Starter



Adder

59GP-SCR-SS0 OAK	59GP-SCR-SS0 MAP	90-Degree Functional Corner Starter with Resin Window and Painted Accent	37" x 62" x 33-1/4"	225	\$7,337	\$7,997
59GC-SCR-SS0 OAK	59GC-SCR-SS0 MAP	90-Degree Functional Corner Starter with Resin Window and Chrome Accent	37" x 62" x 33-1/4"	225	\$8,511	\$9,277
59-SCR-SAO OAK	59-SCR-SAO MAP	90-Degree Functional Corner Adder	37" x 62" x 33-1/4"	195	\$6,077	\$6,624

90° Functional Corner Unit

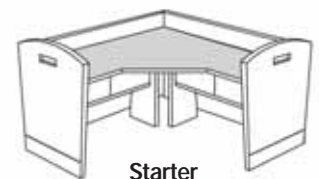

Starter

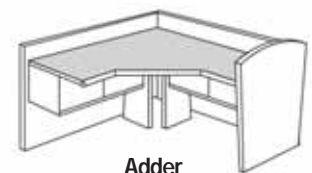

Adder

Please specify Wood Finish (Table 1), High-Pressure Laminate (Table 2), Metal Color (Table 3) and Resin Option; if applicable (Table 6). Details can be found on pages GEN 4, GEN 5 and GEN 6.

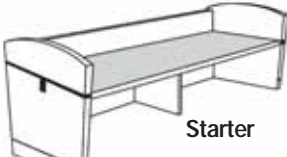
	Oak Catalog No.	Maple Catalog No.	Description	H x W x D	Wt. (lbs.)	Oak Price	Maple Price
Single-Faced Three-Position							
<u>36" Wide Work Surface</u>							
 <p>Starter</p>	59TP-S33-SS0 OAK	59TP-S33-SS0 MAP	Three-Position S/F Starter with Painted Metal "T" Accent	37" x 110-1/2" x 33-1/4"	260	\$4,895	\$5,335
	59TC-S33-SS0 OAK	59TC-S33-SS0 MAP	Three-Position S/F Starter with Chrome "T" Accent	37" x 110-1/2" x 33-1/4"	260	\$5,932	\$6,466
	59-S33-SAO OAK	59-S33-SAO MAP	Three-Position S/F Adder	37" x 109-1/4" x 33-1/4"	230	\$4,503	\$4,908

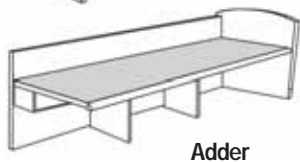

Double-Faced Three-Position							
<u>36" Wide Work Surface</u>							
 <p>Starter</p>	59TP-D33-SS0 OAK	59TP-D33-SS0 MAP	Three-Position D/F Starter with Painted Metal "T" Accent	37" x 110-1/2" x 33-1/4"	445	\$6,319	\$6,888
	59TC-D33-SS0 OAK	59TC-D33-SS0 MAP	Three-Position D/F Starter with Chrome "T" Accent	37" x 110-1/2" x 33-1/4"	445	\$7,657	\$8,346
	59-D33-SAO OAK	59-D33-SAO MAP	Three-Position D/F Adder	37" x 109-1/4" x 33-1/4"	385	\$8,232	\$8,972

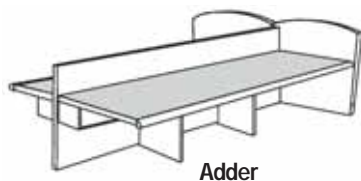

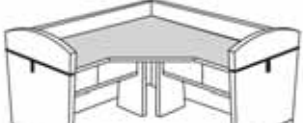
90° Functional Corner Unit							
 <p>Starter</p>	59TP-SCR-SS0 OAK	59TP-SCR-SS0 MAP	90-Degree Functional Corner Starter with Painted Metal "T" Accent	37" x 62" x 33-1/4"	225	\$6,236	\$6,797
	59TC-SCR-SS0 OAK	59TC-SCR-SS0 MAP	90-Degree Functional Corner Starter with Chrome "T" Accent	37" x 62" x 33-1/4"	225	\$7,557	\$8,237
	59-SCR-SAO OAK	59-SCR-SAO MAP	90-Degree Functional Corner Adder	37" x 62" x 33-1/4"	195	\$6,077	\$6,624

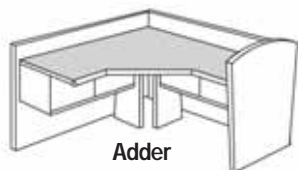

Please specify Wood Finish (Table 1), High-Pressure Laminate (Table 2) and Metal Color (Table 3). Details can be found on pages GEN 4 and GEN 5.

General Specifications

WORK SURFACE

Each work surface is constructed of durable particleboard, and has a high-pressure laminate face that creates a protective, low-glare finish resistant to scratches, fading, and staining. All work surfaces measure a spacious 62"W x 44-1/2"D with a 62" radius, and are 29"H. Two-position units have one top, and four-position units have two.

WORK SURFACE DIVIDER PANEL

Workstation divider panels are designed to provide semi-privacy and workspace definition. In a contemporary twist, all workstation divider panels feature an eye-catching window. Divider panels are made of sturdy, maple-veneered particleboard and measure 17-1/2"H x 42"W x 1-3/4" thick. Four-position units have two work surface divider panels.

WORK SURFACE BASE

All work surface bases measure 27-5/16"H and are made of two pieces of 3/4" maple-veneered particleboard with spacer, which brings the total thickness to 1-3/4". A 3" grommet hole is positioned in the upper rear corner of each panel, creating a convenient wire passage. Four-position units have two work surface bases.

END PANELS

End panels are made of durable, maple-veneered particleboard measuring 47"H. The veneer grain runs vertical on the end panels and all edges receive a 1.6mm thick maple band. In the four-position unit, 3" grommets in the panels are located under the work surface for a convenient wire passage.

CENTER POST

Workstation center posts measure 47-1/4"H x 2-1/4"W x 1-3/4" thick on two-position stations. Four-position center posts measure 47-1/4"H x 1-3/4"W x 1-3/4" thick. All posts are made of solid hard maple and have a 1/2" adjustable floor glide.

ELECTRICAL COMPONENTS

As standard equipment, two-position units have two Brodart model #73-200-S00 lift-up black electrical grommets, which include duplex outlets and data jack ports. Each component measures 6" x 4-1/2" and is located in the corner of each work surface. Four-position units have four lift-up grommets.

As standard equipment, the two- and four-position units have one #73-210-S00 2-1/4" diameter black flexible wire manager, which allows wires to be kept together and out of sight. The wire manager is easily movable, but is weighted at the bottom for secure positioning.

CHROME PLATING SPECIFICATION

Where "chrome plated" is specified, Brodart provides a decorative chromium electro-plated finish that protects against tarnish and minimizes scratching. The brilliance of the chrome plating enhances the overall look of the piece and creates a high-quality furniture grade finish.

WINDOW SPECIFICATIONS

Unless otherwise specified, all resin window panels are 1/4" thick, resin material. Customers may specify the preferred tint color from those offered by Brodart. Window panels are securely held in place by 1/4" thick solid wood maple molding on both sides.

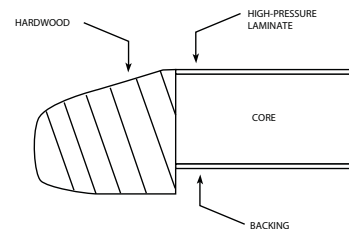

Epoch Series Edge

Oak Catalog No.	Maple Catalog No.	Description	H x W x D	Wt. (lbs.)	Oak Price	Maple Price	
59-822-S00 OAK	59-822-S00 MAP	S/F Two Position Computer Workstation	47-1/2" x 60" x 46-3/4"	290	\$6,579	\$7,171	Two Position Computer Workstation
59-824-S00 OAK	59-824-S00 MAP	D/F Four Position Computer Workstation	47-1/2" x 60" x 90-3/16"	480	\$11,881	\$12,950	Four Position Computer Workstation

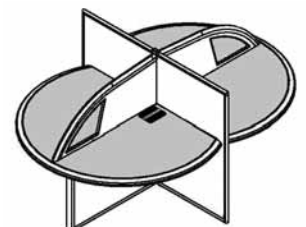
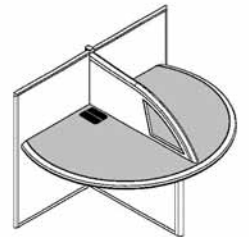

Please specify Wood Finish (Table 1), High-Pressure Laminate (Table 2), Metal Color (Table 3) and Resin Option, if applicable (Table 6). Details can be found on pages GEN 4, GEN 5 and GEN 6.

General Specifications

STATION TOP

Each top is 47"W at the front, tapering to 21-3/16" at the rear. Tops are 28-1/2"D plus a 1-1/2"W cord drop runs the width of the station between the top and back panel to allow passage of electrical and data cords. Station tops are 1-3/16" thick, 45# density particleboard core including a top surface of .050" thick, high-pressure laminate and a backing sheet .020" thick, for balanced construction. High-pressure laminate has a lo-glare finish resistant to scratches, fading and staining in accordance with NEMA standards. The front edge of the top is banded with a 2" x 1-3/4"W solid maple external edge band glued to the work surface core after lamination of the face plastic. The edge band is beveled at 20° to a 1/2" radius bullnose at the leading edge.

VERTICAL PANELS

End and intermediate panels are 1-3/16" thick, 45# density particleboard core. Veneer on both faces of the panels are plain-sliced maple and slip matched. The vertical edges of the panel and top edge receive a 1.6mm edge band.

ELECTRICAL ACCESS DOOR

(One for each 3- or 6-station unit) Access door is 3/4" thick, comprised of select face veneers of maple over a particleboard core. Panel is externally banded on all four sides with a 1/4" thick solid maple edge band. Door have a full-length hinge and have a lock. Access door is located on one back panel, which can be located anywhere in the PAC station.

BACK PANEL

The back panel is 1-3/16" thick, 3-ply 45# density particle-board core with select plain-sliced, slip-matched maple veneer on both faces. The panel is externally banded with 1.6mm thick solid maple on both the bottom edge and the top edge.

Back panels are attached to end and intermediate panels using hidden metal keyways and shoulder screws. Back panels have a 3" diameter grommets egress for electrical cords to pass to the center hub of half-hexagon station configurations.

SHELVES

Shelves are 3/4" thick, select maple veneered 45# density particleboard having a 5/8" thick 1-3/4"H solid maple front edge band.

CENTER CAP

The center caps are 3/4" thick, 45# density particleboard, with high-pressure laminate to match the tops and shaped to enclose half-hexagon and full-hexagon station configurations.

WORKING SPACE

The working space is adjustable to: Standing Height 39", ADA Height 32" and Sitting Height 27".

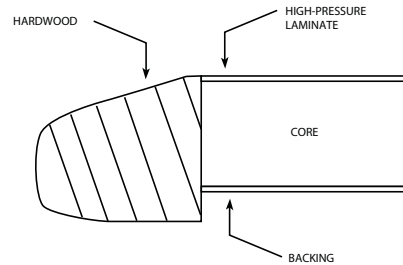

Epoch Series Edge

	Oak Catalog No.	Maple Catalog No.	Description	H x W x D	Wt. (lbs.)	Oak Price	Maple Price
Six Position PAC Station	59-682-S00 OAK	59-682-S00 MAP	Six position with angular tops.	45-1/4" x 101-1/2" x 101-1/2"	500	\$12,552	\$13,681

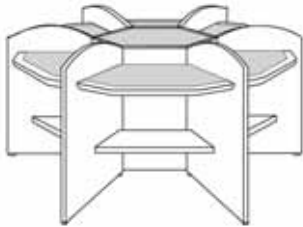

Three Position PAC Station	59-685-S00 OAK	59-685-S00 MAP	Three position with angular tops. Composed of one starter unit and two adder units.	45-1/4" x 101-1/2" x 50-3/4"	265	\$7,835	\$8,540
----------------------------	----------------	----------------	---	------------------------------	-----	---------	---------

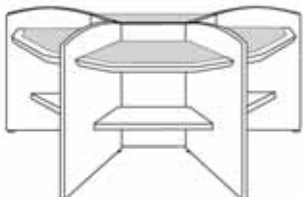

Please specify Wood Finish (Table 1), High-Pressure Laminate (Table 2) and Metal Color (Table 3). Details can be found on pages GEN 4 and GEN 5.

General Specifications

This unit consists of a C.P.U. cabinet, a work surface, end panels and monitor shield.

C.P.U. STORAGE CABINET

The C.P.U. storage cabinet is constructed of 3/4" maple veneer plywood, that matches the end panels. The cabinet is 22-1/4"H x 24"W x 23-1/2"D. Inside cabinet dimensions are 20"H x 22-1/2"W x 22"D. The front has two doors, that can be locked. The cabinet is attached to the underside of the work surface. The bottom of the cabinet has a 3" grommet in each rear corner for wire passage.

WORK SURFACE

The work surface is 1-3/16" thick, 3-ply 45# density particleboard core with .050" high-pressure laminate face and a .020" thick phenolic backing sheet on the underside. The high-pressure laminate has a lo-glare finish resistant to scratches, fading, and staining in accordance with NEMA standards.

The front edge of the work surface an external maple edge band 2"W x 1-3/4" T to match the shape of the edge on the tables. The rear edge has an external 5/8"W x 1-5/8" T bullnose solid maple band. A 3" grommet centered 6" from the back edge allows wires and heat to escape the cabinet.

END PANELS

The end panels measure 48-5/32"H x 33-1/8"W x 1-3/16" thick and include 1/2"H leveling glides. The end panels are plain sliced, slip matched maple veneers on a particleboard core of 45# density. The edges receive 1.6mm thick maple bands with top and vertical edges bullnosed. The vertical edges are also tapered down 2° from top to bottom. The top edge is arched with a 47-3/8" radius. A resin panel window 3-3/4"H x 8-1/2"W is inserted 3-1/4" down from the center of the top edge (see Window Specifications). The resin is held in place with

1/4" thick maple molding on both sides of the window. The molding is sanded flush on both panel surfaces. A 1/4" x 1/4" x 3/16" chrome plated or powder-coat painted square steel rod is embedded 4" from the bottom edge of the panel.

MONITOR SHIELD

A monitor shield is bolted to the work surface 1-5/8" from the rear edge. It is 9"H x 18"W with a 9" radius shape. The material is 1/8" thick steel, black textured powder-coated.

CHROME PLATING SPECIFICATION

Where "chrome plated" is specified, Brodart uses a decorative chromium electro-plated finish that protects against tarnish and minimizes scratching. Brodart Class AA chrome plating requires a .004" to .005" thick layer of bright nickel and a layer of chromium to produce a high-quality furniture grade finish.

WINDOW SPECIFICATIONS

Unless otherwise specified, all resin window panels are 1/4" thick. Customers must specify the tint color they require from those offered by Brodart. Resin is held in place by 1/4" thick solid wood maple molding, on both sides of the window. The molding is sanded flush with the panel surfaces.

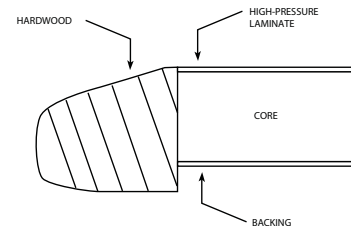

Epoch Series Edge

Oak Catalog No.	Maple Catalog No.	Description	H x W x D	Wt. (lbs.)	Oak Price	Maple Price
59GP-039-S00 OAK	59GP-039-S00 MAP	OPAC Station with Resin Window and Painted Accent	48-1/8" x 26-1/4" x 33"	296	\$3,715	\$4,050
59GC-039-S00 OAK	59GC-039-S00 MAP	OPAC Station with Resin Window and Chrome Accent	48-1/8" x 26-1/4" x 33"	296	\$4,375	\$4,768
59TP-039-S00 OAK	59TP-039-S00 MAP	OPAC Station with Painted Metal "T" Accent	48-1/8" x 26-1/4" x 33"	296	\$2,784	\$3,035
59TC-039-S00 OAK	59TC-039-S00 MAP	OPAC Station with Painted Chrome "T" Accent	48-1/8" x 26-1/4" x 33"	296	\$3,788	\$4,129

OPAC Station

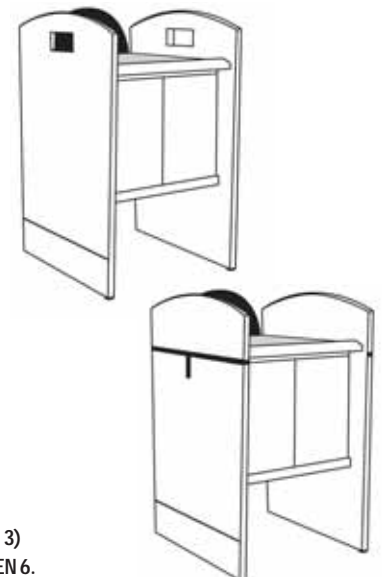

Please specify Wood Finish (Table 1), High-Pressure Laminate (Table 2), Metal Color (Table 3) and Resin Option; if applicable (Table 6). Details can be found on pages GEN 4, GEN 5 and GEN 6.

General Specifications

TOP

The sloped top is 1-3/16" thick, 3-ply particleboard including a top surface of .050" thick high-pressure laminate, with a backing sheet not less than .020" thick. The back edge band is solid wood 1/4" thick and the front edge is 2" wide x 1-3/4" thick with the Epoch shape.

STAND

The back edge is internal and the front edge is external. A 5/8" x 5/8" solid wood book retainer strip is positioned at the front edge of the sloped top. The back, bottom, and shelf are 3/4" thick furniture grade plywood. The ends are 1-3/16" thick furniture-grade plywood with a bullnosed 5/8" thick edge on the top and vertical edges and 5/8" thick flat edge on the bottom edge. The bottom has adjustable floor glides. The vertical edges of the end panels angle out from the bottom at 92° the top edge has a 17-5/8" radius.

Toward the top center of each end panel is a resin window 9" x 3". The type of window is specified on the order, as many patterns and colors are available. A metal strip 1/4" x 1/4" is embedded 3/16" deep into the panel on the outside 4" up from the bottom edge. This strip is chrome or powder-coat as specified.

METAL "T" ACCENT

A 1-1/4" x 1/4" metal strip with a 6" center leg is embedded 3/16" deep across the panel towards the top and is chromed or powder-coated as specified.

SHELVES

There is one adjustable shelf that rests on 5/15-18 x 1" pins.

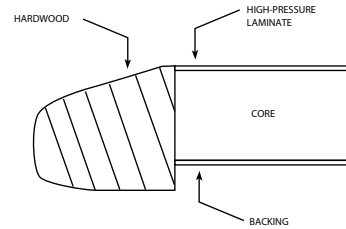

Epoch Series Edge

	Oak Catalog No.	Maple Catalog No.	Description	H x W x D	Wt. (lbs.)	Oak Price	Maple Price
	59GP-869-S00 OAK	59GP-869-S00 MAP	Dictionary Stand with Resin Window and Painted Accent	47-1/2" x 24-3/8" x 18-11/16"	200	\$4,059	\$4,424
	59GC-869-S00 OAK	59GC-869-S00 MAP	Dictionary Stand with Resin Window and Chrome Accent	47-1/2" x 24-3/8" x 18-11/16"	200	\$4,719	\$5,144
	59TP-869-S00 OAK	59TP-869-S00 MAP	Dictionary Stand with Painted Metal "T" Accent	47-1/2" x 24-3/8" x 18-11/16"	200	\$3,472	\$3,784
	59TC-869-S00 OAK	59TC-869-S00 MAP	Dictionary Stand with Painted Chrome "T" Accent	47-1/2" x 24-3/8" x 18-11/16"	200	\$4,181	\$4,558

Please specify Wood Finish (Table 1), High-Pressure Laminate (Table 2), Metal Color (Table 3) and Resin Option; if applicable (Table 6). Details can be found on pages GEN 4, GEN 5 and GEN 6.

General Specifications

TOP

The sloped top is 1-3/16" thick, 3-ply particleboard including a top surface of .050" thick high-pressure laminate, with a backing sheet not less than .020" thick. The back edge band is solid wood 1/4" thick and the front edge is 2" wide x 1-3/4" thick with the Epoch shape.

STAND

The back edge is internal and the front edge is external. A 5/8" x 5/8" solid wood book retainer strip is positioned at the front edge of the sloped top. The back, bottom, and shelf are 3/4" thick furniture grade plywood. The ends are 1-3/16" thick furniture grade plywood with a bullnosed 5/8" thick edge on the top and vertical edges and 5/8" thick flat edge on the bottom edge. The bottom has adjustable floor glides. The vertical edges of the end panels angle out from the bottom at 92° the top edge has a 17-5/8" radius.

Toward the top center of each end panel is a resin window 9" x 3". The type of window is specified on the order, as many patterns and colors are available. A metal strip 1/4" x 1/4" is embedded 3/16" deep into the panel on the outside 4" up from the bottom edge. This strip is chrome or powder-coat as specified.

METAL "T" ACCENT

A 1-1/4" x 1/4" metal strip with a 6" center leg is embedded 3/16" deep across the panel towards the top and is chromed or powder-coated as specified.

SHELVES

There is one adjustable shelf that rests on 5/15-18 x 1" pins.

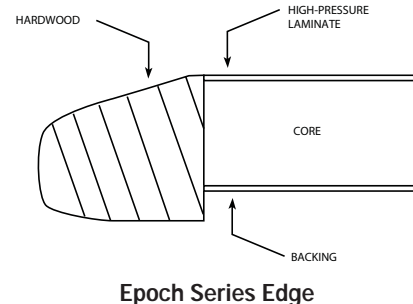

Oak Catalog No.	Maple Catalog No.	Description	H x W x D	Wt. (lbs.)	Oak Price	Maple Price
59GP-871-S00 OAK	59GP-871-S00 MAP	Atlas Stand with Resin Window and Painted Accent	47-9/16" x 28-3/8" x 33-1/8"	225	\$4,984	\$5,433
59GC-871-S00 OAK	59GC-871-S00 MAP	Atlas Stand with Resin Window and Chrome Accent	47-9/16" x 28-3/8" x 33-1/8"	225	\$5,643	\$6,151
59TP-871-S00 OAK	59TP-871-S00 MAP	Atlas Stand with Painted Metal "T" Accent	47-9/16" x 28-3/8" x 33-1/8"	225	\$4,381	\$4,776
59TC-871-S00 OAK	59TC-871-S00 MAP	Atlas Stand with Painted Chrome "T" Accent	47-9/16" x 28-3/8" x 33-1/8"	225	\$5,065	\$5,521

Atlas Stand

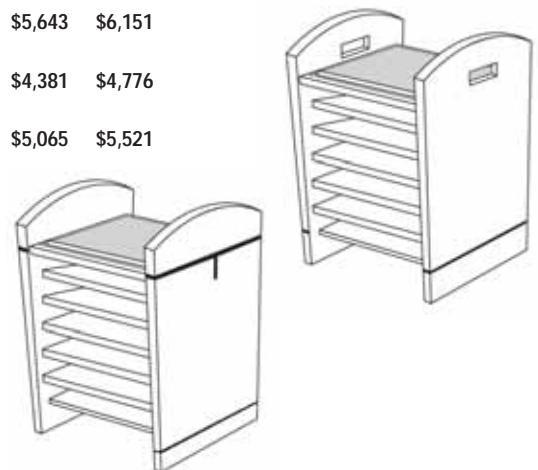

Please specify Wood Finish (Table 1), High-Pressure Laminate (Table 2), Metal Color (Table 3) and Resin Option; if applicable (Table 6). Details can be found on pages GEN 4, GEN 5 and GEN 6.

General Specifications

This spacious unit consists of a cabinet of 3/4" thick maple veneer plywood 51-3/16"H x 36-7/8"W x 28-7/16"D. It has a 3/4" thick maple veneer plywood back with five drawers for storage or display of DVD or CD cases. This unit has design end panels to match other pieces in the Epoch Series. Approximate capacity for CD's is 624 for 525 for DVD's.

DRAWERS

The drawers are constructed of 1/2" solid maple with a maple plywood bottom and front banded on all edges with 1.6mm solid maple. The grain direction runs vertically and the five drawer fronts are cut out of one sheet so that the grain all matches each other on each drawer front. The drawer bottom is cut to allow for five metal tracks with a metal follower block in each track to run from front to back of the drawer. This follower block is adjustable and holds the CD's and DVD's in an upright position. Each drawer to receive 100# load capacity full extension drawer slides. Each drawer receives two chrome drawer pulls for easy opening and closing. The unit has a mechanism that allows only one drawer to be open at a time so that the unit does not tip over.

END PANELS

End panels measure 51-3/16"H x 28-7/16"W x 1-3/16" thick with plain sliced slip matched hard maple veneers and 45# density particleboard core. The edges are banded with 1.6mm solid maple. The front and rear vertical edges taper down 2° from the top edge. The top edge is arched at a 52" radius. Down 3-3/4" from the top edge a window of resin is centered on the panel. The size of the window with molding is 29-1/4" vertically x 2-1/2"W. (See Window Specifications) a square 1/4" x 1/4" rod is inserted into the surface of the end panel 3/16"D and is chrome plated or powder-coated as specified by the owner. (See Chrome Plating Specifications).

CHROME PLATING SPECIFICATION

Where "chrome plated" is specified, Brodart uses a decorative chromium electro-plated finish, which protects against tarnish and minimizes scratching. Brodart Class AA chrome plating requires a .004" to .005" thick layer of bright nickel and a layer of chromium to produce a high-quality furniture grade finish.

WINDOW SPECIFICATIONS

Unless otherwise specified all resin window panels are 1/4" thick. The customer must specify the resin color that they require from those offered by Brodart. The resin is held in place by 1/4" thick solid wood maple molding on both sides of the resin. The molding is sanded flush with the panel surfaces.

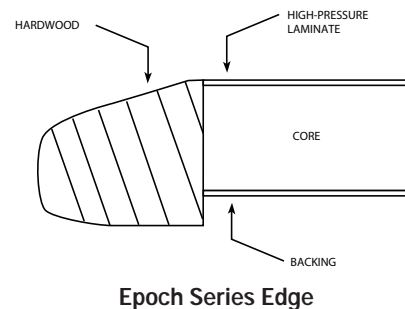

Oak Catalog No.	Maple Catalog No.	Description	H x W x D	Wt. (lbs.)	Oak Price	Maple Price	Starter	Adder
59GP-771-S03 OAK	59GP-771-S03 MAP	Starter Unit with Resin Window and Painted Accent	51-3/16" x 36-7/8" x 28-7/16"	250	\$8,838	\$9,634		Display Unit
59GC-771-S03 OAK	59GC-771-S03 MAP	Starter Unit with Resin Window and Chrome Accent	51-3/16" x 36-7/8" x 28-7/16"	250	\$9,722	\$10,597		
59TP-771-S03 OAK	59TP-771-S03 MAP	Starter Unit with Painted Metal "T" Accent	51-3/16" x 36-7/8" x 28-7/16"	250	\$8,767	\$9,556		
59TC-771-S03 OAK	59TC-771-S03 MAP	Starter Unit with Painted Chrome "T" Accent	51-3/16" x 36-7/8" x 28-7/16"	250	\$10,521	\$11,468		
59-771-S04 OAK	59-771-S04 MAP	Adder Unit	51-3/16" x 35-11/16" x 28-7/16"	230	\$8,214	\$8,953		
59GP-771-S00 OAK	59GP-771-S00 MAP	Starter Unit with Resin Window and Painted Accent	51-3/16" x 36-7/8" x 28-7/16"	250	\$8,948	\$9,753		Storage Unit
59GC-771-S00 OAK	59GC-771-S00 MAP	Starter Unit with Resin Window and Chrome Accent	51-3/16" x 36-7/8" x 28-7/16"	250	\$11,147	\$12,150		
59TP-771-S00 OAK	59TP-771-S00 MAP	Starter Unit with Painted Metal "T" Accent	51-3/16" x 36-7/8" x 28-7/16"	250	\$8,870	\$9,669		
59TC-771-S00 OAK	59TC-771-S00 MAP	Starter Unit with Painted Chrome "T" Accent	51-3/16" x 36-7/8" x 28-7/16"	250	\$10,643	\$11,601		
59-771-S02 OAK	59-771-S02 MAP	Adder Unit	51-3/16" x 35-11/16" x 28-7/16"	230	\$8,324	\$9,073		

Please specify Wood Finish (Table 1), High-Pressure Laminate (Table 2), Metal Color (Table 3) and Resin Option; if applicable (Table 6). Details can be found on pages GEN 4, GEN 5 and GEN 6.

Oak Catalog No.	Maple Catalog No.	Description	Wt. (lbs.)	Oak Price	Maple Price
<i>To Cover ONE UNIT</i>					
59-W10-S01 OAK	59-W10-S01 MAP	10"D, Single-Faced	11	\$370	\$389
59-W12-S01 OAK	59-W12-S01 MAP	12"D, Single-Faced	14	\$391	\$410
59-W20-S01 OAK	59-W20-S01 MAP	20"D, Double-Faced	23	\$640	\$672
59-W24-S01 OAK	59-W24-S01 MAP	24"D, Double-Faced	27	\$683	\$717
<i>To Cover TWO UNITS</i>					
59-W10-S02 OAK	59-W10-S02 MAP	10"D, Single-Faced	22	\$504	\$529
59-W12-S02 OAK	59-W12-S02 MAP	12"D, Single-Faced	28	\$549	\$576
59-W20-S02 OAK	59-W20-S02 MAP	20"D, Double-Faced	46	\$902	\$947
59-W24-S02 OAK	59-W24-S02 MAP	24"D, Double-Faced	54	\$1,001	\$1,051
<i>To Cover THREE UNITS</i>					
59-W10-S03 OAK	59-W10-S03 MAP	10"D, Single-Faced	33	\$629	\$660
59-W12-S03 OAK	59-W12-S03 MAP	12"D, Single-Faced	42	\$701	\$736
59-W20-S03 OAK	59-W20-S03 MAP	20"D, Double-Faced	69	\$1,220	\$1,281
59-W24-S03 OAK	59-W24-S03 MAP	24"D, Double-Faced	81	\$1,266	\$1,329
<i>To Cover FOUR UNITS</i>					
59-W10-S04 OAK	59-W10-S04 MAP	10"D, Single-Faced	44	\$851	\$894
59-W12-S04 OAK	59-W12-S04 MAP	12"D, Single-Faced	56	\$938	\$985
59-W20-S04 OAK	59-W20-S04 MAP	20"D, Double-Faced	92	\$1,521	\$1,597
59-W24-S04 OAK	59-W24-S04 MAP	24"D, Double-Faced	108	\$1,714	\$1,801
<i>To Cover FIVE UNITS</i>					
59-W10-S05 OAK	59-W10-S05 MAP	10"D, Single-Faced	55	\$965	\$1,014
59-W12-S05 OAK	59-W12-S05 MAP	12"D, Single-Faced	70	\$1,092	\$1,147
59-W20-S05 OAK	59-W20-S05 MAP	20"D, Double-Faced	115	\$1,839	\$1,931
59-W24-S05 OAK	59-W24-S05 MAP	24"D, Double-Faced	135	\$1,979	\$2,078
<i>To Cover SIX UNITS</i>					
59-W10-S06 OAK	59-W10-S06 MAP	10"D, Single-Faced	66	\$1,102	\$1,157
59-W12-S06 OAK	59-W12-S06 MAP	12"D, Single-Faced	84	\$1,245	\$1,307
59-W20-S06 OAK	59-W20-S06 MAP	20"D, Double-Faced	138	\$2,161	\$2,269
59-W24-S06 OAK	59-W24-S06 MAP	24"D, Double-Faced	162	\$2,248	\$2,360
<i>To Cover SEVEN UNITS</i>					
59-W10-S07 OAK	59-W10-S07 MAP	10"D, Single-Faced	77	\$1,324	\$1,391
59-W12-S07 OAK	59-W12-S07 MAP	12"D, Single-Faced	98	\$1,483	\$1,557
59-W20-S07 OAK	59-W20-S07 MAP	20"D, Double-Faced	161	\$2,458	\$2,581
59-W24-S07 OAK	59-W24-S07 MAP	24"D, Double-Faced	189	\$2,696	\$2,831
<i>To Cover EIGHT UNITS</i>					
59-W10-S08 OAK	59-W10-S08 MAP	10"D, Single-Faced	88	\$1,451	\$1,524
59-W12-S08 OAK	59-W12-S08 MAP	12"D, Single-Faced	112	\$1,637	\$1,719
59-W20-S08 OAK	59-W20-S08 MAP	20"D, Double-Faced	184	\$2,778	\$2,917
59-W24-S08 OAK	59-W24-S08 MAP	24"D, Double-Faced	216	\$2,949	\$3,097
<i>To Cover NINE UNITS</i>					
59-W10-S09 OAK	59-W10-S09 MAP	10"D, Single-Faced	99	\$1,620	\$1,701
59-W12-S09 OAK	59-W12-S09 MAP	12"D, Single-Faced	126	\$1,831	\$1,923
59-W20-S09 OAK	59-W20-S09 MAP	20"D, Double-Faced	207	\$3,139	\$3,296
59-W24-S09 OAK	59-W24-S09 MAP	24"D, Double-Faced	243	\$3,272	\$3,435

Note: Edge banding on the end of tops receive mitred corners. Single-Faced Tops are banded on both ends and on the front edge only. Back edge is not banded. Double-Faced Tops are banded on both ends and on the front and back edges.

Please specify Wood Finish (Table 1) and High-Pressure Laminate (Table 2). Details can be found on page GEN 4.

Oak Catalog No.	Maple Catalog No.	Description	Wt. (lbs.)	Oak Price	Maple Price
<i>To Cover ONE UNIT</i>					
59-S10-S01 OAK	59-S10-S01 MAP	10"D, Single-Faced	11	\$370	\$389
59-S12-S01 OAK	59-S12-S01 MAP	12"D, Single-Faced	14	\$391	\$410
59-S20-S01 OAK	59-S20-S01 MAP	20"D, Double-Faced	23	\$640	\$672
59-S24-S01 OAK	59-S24-S01 MAP	24"D, Double-Faced	27	\$683	\$717
<i>To Cover TWO UNITS</i>					
59-S10-S02 OAK	59-S10-S02 MAP	10"D, Single-Faced	22	\$504	\$529
59-S12-S02 OAK	59-S12-S02 MAP	12"D, Single-Faced	28	\$549	\$576
59-S20-S02 OAK	59-S20-S02 MAP	20"D, Double-Faced	46	\$902	\$947
59-S24-S02 OAK	59-S24-S02 MAP	24"D, Double-Faced	54	\$1,001	\$1,051
<i>To Cover THREE UNITS</i>					
59-S10-S03 OAK	59-S10-S03 MAP	10"D, Single-Faced	33	\$629	\$661
59-S12-S03 OAK	59-S12-S03 MAP	12"D, Single-Faced	42	\$701	\$736
59-S20-S03 OAK	59-S20-S03 MAP	20"D, Double-Faced	69	\$1,220	\$1,281
59-S24-S03 OAK	59-S24-S03 MAP	24"D, Double-Faced	81	\$1,266	\$1,329
<i>To Cover FOUR UNITS</i>					
59-S10-S04 OAK	59-S10-S04 MAP	10"D, Single-Faced	44	\$851	\$894
59-S12-S04 OAK	59-S12-S04 MAP	12"D, Single-Faced	56	\$938	\$985
59-S20-S04 OAK	59-S20-S04 MAP	20"D, Double-Faced	92	\$1,521	\$1,597
59-S24-S04 OAK	59-S24-S04 MAP	24"D, Double-Faced	108	\$1,714	\$1,801
<i>To Cover FIVE UNITS</i>					
59-S10-S05 OAK	59-S10-S05 MAP	10"D, Single-Faced	55	\$965	\$1,014
59-S12-S05 OAK	59-S12-S05 MAP	12"D, Single-Faced	70	\$1,092	\$1,147
59-S20-S05 OAK	59-S20-S05 MAP	20"D, Double-Faced	115	\$1,839	\$1,931
59-S24-S05 OAK	59-S24-S05 MAP	24"D, Double-Faced	135	\$1,979	\$2,078
<i>To Cover SIX UNITS</i>					
59-S10-S06 OAK	59-S10-S06 MAP	10"D, Single-Faced	66	\$1,102	\$1,157
59-S12-S06 OAK	59-S12-S06 MAP	12"D, Single-Faced	84	\$1,245	\$1,307
59-S20-S06 OAK	59-S20-S06 MAP	20"D, Double-Faced	138	\$2,161	\$2,269
59-S24-S06 OAK	59-S24-S06 MAP	24"D, Double-Faced	162	\$2,248	\$2,360
<i>To Cover SEVEN UNITS</i>					
59-S10-S07 OAK	59-S10-S07 MAP	10"D, Single-Faced	77	\$1,324	\$1,391
59-S12-S07 OAK	59-S12-S07 MAP	12"D, Single-Faced	98	\$1,483	\$1,557
59-S20-S07 OAK	59-S20-S07 MAP	20"D, Double-Faced	161	\$2,458	\$2,581
59-S24-S07 OAK	59-S24-S07 MAP	24"D, Double-Faced	189	\$2,696	\$2,831
<i>To Cover EIGHT UNITS</i>					
59-S10-S08 OAK	59-S10-S08 MAP	10"D, Single-Faced	88	\$1,451	\$1,524
59-S12-S08 OAK	59-S12-S08 MAP	12"D, Single-Faced	112	\$1,637	\$1,719
59-S20-S08 OAK	59-S20-S08 MAP	20"D, Double-Faced	184	\$2,778	\$2,917
59-S24-S08 OAK	59-S24-S08 MAP	24"D, Double-Faced	216	\$2,949	\$3,097
<i>To Cover NINE UNITS</i>					
59-S10-S09 OAK	59-S10-S09 MAP	10"D, Single-Faced	99	\$1,620	\$1,701
59-S12-S09 OAK	59-S12-S09 MAP	12"D, Single-Faced	126	\$1,831	\$1,923
59-S20-S09 OAK	59-S20-S09 MAP	20"D, Double-Faced	207	\$3,139	\$3,296
59-S24-S09 OAK	59-S24-S09 MAP	24"D, Double-Faced	243	\$3,272	\$3,435

Note: Edge Band on long side only. Tops are designed to be inset between end panels. If edge bands are desired on short edges, please enter the part as a modification and specify which bands to be included.

To ensure that tops for steel shelving work with each manufacturer and top method, please specify the exact width and depth of tops. Add 15% for HPL on top and bottom (Steel Shelving ONLY).

Please specify Wood Finish (Table 1) and High-Pressure Laminate (Table 2). Details can be found on page GEN 4.

General Specifications

END PANELS

End panels are 1-3/16" thick, 3-ply 45# density particleboard core with select plain-sliced, slip-matched maple veneer on the inside and outside face. The vertical edges and top edge of the end panel have a 1.6mm maple external edge band. All panel edges are eased. Exact height and depth of panel must be specified when ordering. End panels are not machined for fastening. No fastening hardware is provided with end panels.

Double-face end panels have an accent window 3-3/4"H x 8-1/2"W. They have a 1/4" x 1/4" square steel rod that is embedded 3/16"D up 4" from the bottom edge and be chrome plated or powder-coated as ordered (see chrome specs). Single-face panels do not receive the accent window.

CHROME PLATING SPECIFICATION

Where "chrome plated" is specified, Brodart uses a decorative chromium electro-plated finish that protects against tarnish and minimizes scratching. Brodart Class AA chrome plating requires a .004" to .005" thick layer of bright nickel and a layer of chromium to produce a high-quality furniture grade finish.

WINDOW SPECIFICATIONS

Unless otherwise specified, all resin window panels are 1/4" thick. Customers must specify the tint color they require from those offered by Brodart. The resin is held in place by 1/4" thick solid wood maple molding on both sides of the resin. The molding is sanded flush with the panel surfaces.

Note: Exact height and depth of panel must be specified when ordering. Epoch style end panels cannot be used with continuous tops that are overhung (out over the panels).

Note: Heights noted are to the bottom of the curve on the top of the panel.

Oak Catalog No.	Maple Catalog No.	Description	Wt. (lbs.)	Oak Price	Maple Price
<i>Single-Faced with Painted Metal Strip</i>					
59P-702 MOD OAK	59P-702 MOD MAP	43-3/4" x 13-7/8"	14	\$461	\$484
59P-703 MOD OAK	59P-703 MOD MAP	43-3/4" x 15-7/8"	16	\$488	\$512
59P-705 MOD OAK	59P-705 MOD MAP	67-3/4" x 13-7/8"	21	\$531	\$558
59P-706 MOD OAK	59P-706 MOD MAP	67-3/4" x 15-7/8"	26	\$557	\$585
59P-708 MOD OAK	59P-708 MOD MAP	79-3/4" x 13-7/8"	25	\$598	\$628
59P-709 MOD OAK	59P-709 MOD MAP	79-3/4" x 15-7/8"	30	\$625	\$656
59P-711 MOD OAK	59P-711 MOD MAP	85-3/4" x 13-7/8"	28	\$605	\$635
59P-712 MOD OAK	59P-712 MOD MAP	85-3/4" x 15-7/8"	33	\$629	\$661
59P-714 MOD OAK	59P-714 MOD MAP	91-3/4" x 13-7/8"	29	\$609	\$640
59P-715 MOD OAK	59P-715 MOD MAP	91-3/4" x 15-7/8"	35	\$635	\$667

Single-Faced End Panels

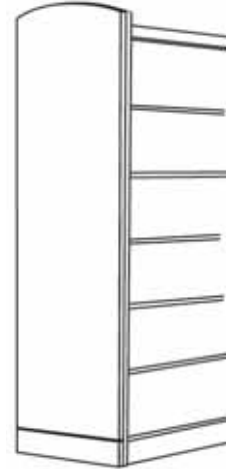

<i>Single-Faced with Chrome Metal Strip</i>					
59C-702 MOD OAK	59C-702 MOD MAP	43-3/4" x 13-7/8"	14	\$531	\$558
59C-703 MOD OAK	59C-703 MOD MAP	43-3/4" x 15-7/8"	16	\$557	\$585
59C-705 MOD OAK	59C-705 MOD MAP	67-3/4" x 13-7/8"	21	\$602	\$632
59C-706 MOD OAK	59C-706 MOD MAP	67-3/4" x 15-7/8"	26	\$627	\$659
59C-708 MOD OAK	59C-708 MOD MAP	79-3/4" x 13-7/8"	25	\$669	\$702
59C-709 MOD OAK	59C-709 MOD MAP	79-3/4" x 15-7/8"	30	\$694	\$729
59C-711 MOD OAK	59C-711 MOD MAP	85-3/4" x 13-7/8"	28	\$675	\$708
59C-712 MOD OAK	59C-712 MOD MAP	85-3/4" x 15-7/8"	33	\$700	\$735
59C-714 MOD OAK	59C-714 MOD MAP	91-3/4" x 13-7/8"	29	\$680	\$714
59C-715 MOD OAK	59C-715 MOD MAP	91-3/4" x 15-7/8"	35	\$707	\$742

<i>Double-Faced with Painted Metal Strip</i>					
59P-722 MOD OAK	59P-722 MOD MAP	43-3/4" x 24-3/8"	27	\$1,110	\$1,166
59P-723 MOD OAK	59P-723 MOD MAP	43-3/4" x 28-3/8"	33	\$1,128	\$1,185
59P-725 MOD OAK	59P-725 MOD MAP	67-3/4" x 24-3/8"	43	\$1,383	\$1,452
59P-726 MOD OAK	59P-726 MOD MAP	67-3/4" x 28-3/8"	52	\$1,401	\$1,470
59P-728 MOD OAK	59P-728 MOD MAP	79-3/4" x 24-3/8"	51	\$1,501	\$1,576
59P-729 MOD OAK	59P-729 MOD MAP	79-3/4" x 28-3/8"	61	\$1,517	\$1,593
59P-731 MOD OAK	59P-731 MOD MAP	85-3/4" x 24-3/8"	55	\$1,511	\$1,586
59P-732 MOD OAK	59P-732 MOD MAP	85-3/4" x 28-3/8"	66	\$1,527	\$1,603
59P-734 MOD OAK	59P-734 MOD MAP	91-3/4" x 24-3/8"	59	\$1,519	\$1,595
59P-735 MOD OAK	59P-735 MOD MAP	91-3/4" x 28-3/8"	60	\$1,536	\$1,613

Double-Faced End Panels



<i>Double-Faced with Chrome Metal Strip</i>					
59C-722 MOD OAK	59C-722 MOD MAP	43-3/4" x 24-3/8"	27	\$1,179	\$1,238
59C-723 MOD OAK	59C-723 MOD MAP	43-3/4" x 28-3/8"	33	\$1,197	\$1,257
59C-725 MOD OAK	59C-725 MOD MAP	67-3/4" x 24-3/8"	43	\$1,454	\$1,527
59C-726 MOD OAK	59C-726 MOD MAP	67-3/4" x 28-3/8"	52	\$1,470	\$1,544
59C-728 MOD OAK	59C-728 MOD MAP	79-3/4" x 24-3/8"	51	\$1,571	\$1,650
59C-729 MOD OAK	59C-729 MOD MAP	79-3/4" x 28-3/8"	61	\$1,588	\$1,668
59C-731 MOD OAK	59C-731 MOD MAP	85-3/4" x 24-3/8"	55	\$1,581	\$1,660
59C-732 MOD OAK	59C-732 MOD MAP	85-3/4" x 28-3/8"	66	\$1,597	\$1,677
59C-734 MOD OAK	59C-734 MOD MAP	91-3/4" x 24-3/8"	59	\$1,590	\$1,670
59C-735 MOD OAK	59C-735 MOD MAP	91-3/4" x 28-3/8"	60	\$1,607	\$1,688

Note: Epoch style end panels cannot be used with continuous tops that are overhung (out over the panels).

Please specify Wood Finish (Table 1), Metal Color (Table 3) and Resin Option; if applicable (Table 6). Details can be found on pages GEN 4, GEN 5 and GEN 6.

General Specifications

TABLETOPS

Tabletops are 1-3/16" thick, 3-ply 45# density particleboard core or with a .050" high-pressure laminate with a .020" thick phenolic backing sheet on the underside. High-pressure laminate has a low-glare finish resistant to scratches, fading and staining in accordance with NEMA standards. Tabletops are banded on exposed edges with a 1-3/4" thick x 2" wide solid maple external chamfered edge band applied to the table core after lamination of the face plastic. The edge band is beveled down at a 20° angle with a 1/2" radius bullnose at the leading edge. Square and rectangular tabletop edge bands are mitered at all four corners and corners radiused 1/8".

TABLE LEG- (POWDER-COATED)

Legs are 2-1/2" round, 16-gauge steel tubing. The table is without an apron, with legs attached to the tabletop by a 5" square x 5/16" thick steel plate. Legs and plates are electrostatic powder-coat painted and have no sharp edges. The plate attaches to the leg by a 9" x 3" x 3/8" steel angle bracket placed at a 45° angle. The steel angle bracket receives two cutout designs replicating the edge band profile. The steel bracket is attached to the leg plate and leg using metal to metal fasteners. The strap may be electrostatic powder-coat painted or chrome plated. The leg plate is attached to the tabletop by (5) 5/16" x 1" machine bolts engaging internally and externally threaded bushings embedded in the underside of the tabletop. Leg plates are positioned behind, and hidden by the extended edge band. Edge band extends 1/2" below the tabletop. Each leg has 2-1/2"D x 1"H adjustable glide mounted into a recessed threaded insert.

TABLE LEG-(CHROME)

Legs are 2-1/2" round, 16-gauge steel tubing. The table is without an apron, with legs attached to the tabletop by a 5" square x 5/16" thick steel plate. Leg and plate are painted or plated to match the leg (see chrome specifications) and have no sharp edges. The plate is attached to the leg by a 9" x 3" x 3/8" steel angle bracket placed at a 45° angle. The steel angle bracket receives two cutout designs replicating the edge band profile. The bracket is attached to the leg plate and leg using metal to metal fasteners. The leg plate is attached to the tabletop by (5) 5/16" x 1" machine bolts engaging internally and externally threaded bushings embedded in the underside of the tabletop. Leg plates are positioned behind and hidden by the extended edge band. Edge band extends 1/2" below the tabletop. Each leg has 2-1/2"D x 1"H adjustable glide mounted into a recessed threaded insert.

TABLE LEG- (WOOD)

Legs are 2-1/2" round wood. The table is apronless design with legs attached to the tabletop by a 5" square x 5/16" thick steel plate. Plates are electrostatic powder coat painted and have no sharp edges. The plate attaches to the leg by a 9" x 3" x 3/8" steel angle bracket placed at a 45° angle. The steel angle bracket receives two cutout designs replicating the edge band profile. The steel bracket is attached to the leg plate and leg using metal to metal fasteners. The strap may be electrostatic powder-coat painted or chrome plated. The leg plate is attached to the tabletop by (5) 5/16" x 1" machine bolts engaging internally and externally threaded bushings embedded in the underside of the tabletop. Leg plates are positioned behind, and hidden by the extended edge band. Edge band extends 1/2" below the tabletop. Each leg has 2-1/2"D x 1"H adjustable glide mounted into a recessed threaded insert.

CHROME PLATING SPECIFICATION

Where chrome plated is specified, Brodart uses a decorative chromium electro-plated finish that protects against tarnish and minimizes scratching. Brodart Class AA chrome plating requires a .004" to .005" thick layer of bright nickel and a layer of chromium to produce a high-quality furniture grade finish.

TABLETOP HEIGHT

All tables are 16" high.

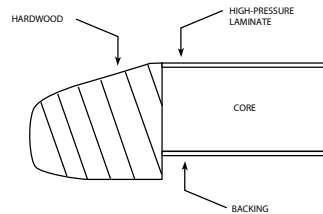

Epoch Series Edge

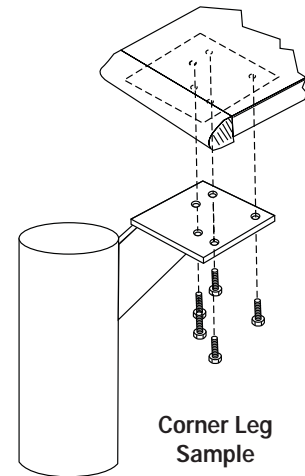

Corner Leg Sample

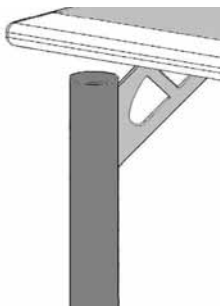

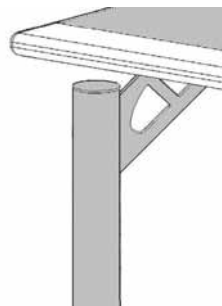

Epoch Powder-Coated Leg Cutout

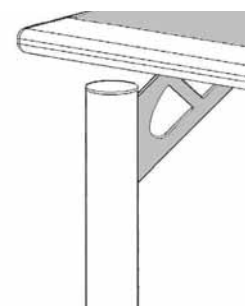

Epoch Chrome Leg Cutout



Epoch Wood Leg Cutout

Oak Catalog No.	Maple Catalog No.	Description	H x W x D	Wt. (lbs.)	Oak Price	Maple Price	
59-610-S00 OAK	59-610-S00 MAP	Round Table with Powder-Coated Legs	16"H x 38" Diameter	66	\$1,918	\$2,147	 <p>Round Table</p>
59C-610-S00 OAK	59C-610-S00 MAP	Round Table with Chrome Legs	16"H x 38" Diameter	66	\$2,302	\$2,576	
59W-610-S00 OAK	59W-610-S00 MAP	Round Table with Wood Legs	16"H x 38" Diameter	66	\$1,918	\$2,147	
59-621-S00 OAK	59-621-S00 MAP	Square Table with Powder-Coated Legs	16" x 30" x 30"	51	\$1,606	\$1,799	 <p>Square Table</p>
59C-621-S00 OAK	59C-621-S00 MAP	Square Table with Chrome Legs	16" x 30" x 30"	51	\$1,927	\$2,158	
59W-621-S00 OAK	59W-621-S00 MAP	Square Table with Wood Legs	16" x 30" x 30"	51	\$1,606	\$1,799	
59-611-S00 OAK	59-611-S00 MAP	Rectangular Table with Powder-Coated Legs	16" x 48" x 24"	46	\$1,499	\$1,678	 <p>Rectangular Table</p>
59C-611-S00 OAK	59C-611-S00 MAP	Rectangular Table with Chrome Legs	16" x 48" x 24"	46	\$1,798	\$2,013	
59W-611-S00 OAK	59W-611-S00 MAP	Rectangular Table with Wood Legs	16" x 48" x 24"	46	\$1,499	\$1,678	

Please specify Wood Finish (Table 1), High-Pressure Laminate (Table 2) and Metal Color (Table 3). Details can be found on pages GEN 4 and GEN 5.

Geometrix



2017 Price List and Specifications Addendum

Brodart Co. Contract Furniture - Made in USA

280 North Road, Clinton County Industrial Park • McElhattan, PA 17748

Toll-Free: 888-521-1884 • E-Mail: furniture@brodart.com • www.brodartfurniture.com

General Specifications

CONSTRUCTION

Shelving construction is modular type, utilizing an Industrial Grade Oriented Strand Board (OSB) as the core with two pieces of High Density Fiber (HDF) laminated to each side of the OSB. Shelving units are designed with the starter and adder concept and measure 36" from center to center of the uprights. Oak and Maple are the standard wood species for Geometrix shelving.

END/FINISHING PANELS

End panels are 1" thick, Industrial Grade Oriented Strand Board (OSB) as the core with two pieces of High Density Fiber (HDF) laminated to each side of the OSB. All edges are banded with matching veneer edgebanding. Edges are square, but eased. Vertical rows of holes are drilled near the front and rear of each panel for shelf adjustment on 32mm centers. Panels are drilled at front, rear, top, and bottom for embedding internal and external threaded bushings. Tops and bases are attached to end panels with 5/16" - 18 x 2" hex-head bolts and washers. Lag bolts or wood screws are not used.

INTERMEDIATE UPRIGHT PANELS AND TRANSITIONAL PANELS

Intermediate uprights are 1" thick, Industrial Grade Oriented Strand Board (OSB) as the core with two pieces of High Density Fiber (HDF) laminated to each side of the OSB. All edges are banded with matching veneer edgebanding. Edges are square, but eased. Shelf pinholes are bored on both sides of the panel, but staggered so that pins can be deeply seated. Panels are drilled through at front, rear, top, and bottom for attachment of tops and bases with 5/16"-18 x 4-1/2" hex-head bolts, nuts, and washers.

BASE

The base front is 3-1/4" H X 3/4" thick Industrial Grade Oriented Strand Board (OSB) as the core with two pieces of High Density Fiber (HDF) laminated to each side of the OSB with a 3/4" thick base shelf. A 2" x 3/4" full-length rail is tenoned to the inside of the front. Bolting cleats 1-1/4" x 1-1/4" are glued and stapled perpendicular at the ends of the rail and drilled to allow assembly bolts to pass through. A second full-length rail is glued and stapled to the rear of the bolting cleats for support and proper alignment. Bases are manufactured so the base shelf rests on the top of the base front.

ATTACHMENT

Four bolts are used to attach each single-faced base or top. Eight bolts are used to attach each double-faced base or top, except for 23"D double-faced units, on which sixteen bolts are used. All hardware is concealed from view after assembly. Hardware kits for attaching single-faced units to the wall are available upon request and are sold separately.

BACKS AND PARTITIONS

Backs and partitions are constructed of 3-ply or 5-ply furniture-grade Oak or Maple veneered plywood finished on both sides to match shelving.

Note: Backs must be ordered separately.

STARTERS AND ADDERS

Starters and Adders include top, base, and shelves. Starters include one end panel, shelf pins and joining holes on inside only. Adders include one intermediate upright panel with shelf pins and joining holes on both sides. Finishing panels include shelf pins and joining holes on inside only.

Note: A finishing panel must be ordered separately to finish shelving.



Starter

Includes one end panel, shelf pins and joining holes on inside only. 37-3/16"W overall.

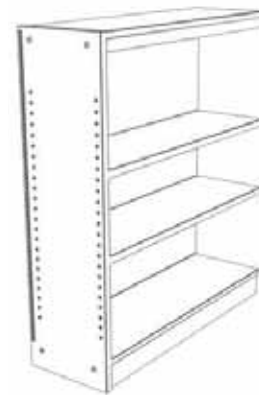

Adder

Includes one intermediate upright with shelf pins and joining holes on both sides. 36-3/16"W overall.



Finishing Panel

General Specifications - Tops and Towers

WOOD SHELVING TOPS

Cornice tops have a 1-1/2" fascia, 3/4" thick, Industrial Grade Oriented Strand Board (OSB) as the core with two pieces of High Density Fiber (HDF) laminated to each side of the OSB, glued to a 3/4" thick Industrial Grade Oriented Strand Board (OSB) as the core with two pieces of High Density Fiber (HDF) laminated to each side of the OSB, of specified depth. On the inside surface of the top at each end, butted to the fascia, is a solid hardwood bolting cleat 1-1/4" x 1-1/4" that is both glued and stapled. For additional strength, three 1-3/4" cleats are added at the intersection of the fascia and top panel. Bolting cleats are drilled to allow assembly bolts to pass through.

Note: Tops on 72"H units are inverted.

TRIANGLE TOWERS AND TRANSITIONAL TRIANGLE TOWERS

Triangle Towers are created using 1" thick, Industrial Grade Oriented Strand Board (OSB) as the core with two pieces of High Density Fiber (HDF) laminated to each side of the OSB. All edges are banded with matching veneer edgebanding. Edges are square, but eased. Vertical rows of holes are drilled near the front and rear of each panel for shelf adjustment on 32mm centers. Towers are assembled using 1-3/4" cleats attached to the inside of the tower panel. Panels are drilled at front, top, and bottom for embedding internal and external threaded bushings. Tops and bases are attached to triangle towers with 5/16" - 18 x 2" hex-head bolts and washers. Lag bolts or wood screws are not used.

General Specifications - Shelves & Mobile Units

WOOD SHELVES

Shelves are 1" thick, Industrial Grade Oriented Strand Board (OSB) as the core with two pieces of High Density Fiber (HDF) laminated to each side of the OSB. Adjustable shelves are notched 3/8" wide x 3/16" high x 3/4" long on the underside to set firmly on 1" long, 5/16" diameter threaded shelf pins, cadmium-plated. Shelf depths are nominal.

MOBILE SHELVING UNITS

Mobile Shelving is available on 36", 42", 48", and 60-1/2" units. Shelving construction is the same as the standard shelving with the exception of the base; the base facing is 3-3/16"H. Four 2-1/2" diameter heavy-duty swivel casters attached to a 14 gauge caster bracket will be attached to the bottom of the unit with four #12 x 3/4" wood screws each. The caster assembly is hidden within the base, giving the appearance of standard unit.

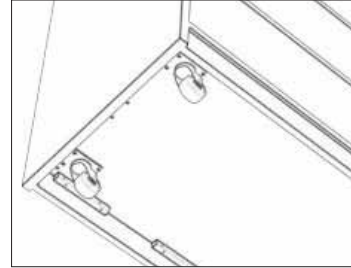

Bottom Caster View



Linear One Bay Mobile Unit



Linear Two Bay Mobile Unit

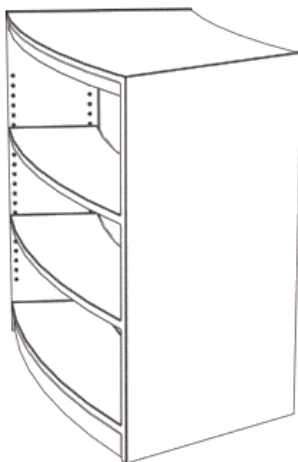

Arc One Bay Mobile Unit



Arc Two Bay Mobile Unit

General Specifications

CONSTRUCTION

Shelving construction is modular type, utilizing thermally-fused laminate panels. Shelving units are designed with the starter and adder concept and measure 36" from center to center of the uprights. Oak, Classic Maple, Canadian Gray, Classic Black, and Bright White are the standard finishes for laminate shelving uprights, tops, and bases. Shelves are available in Orange, Red, Plum, Island Green, and Lapis Blue, in addition to the colors listed previously.

END/FINISHING PANELS

End panels are 1" thick thermally-fused laminate panels. All edges are banded with matching 2MM PVC edgebanding. Edges are square, but eased. Vertical rows of holes are drilled near the front and rear of each panel for shelf adjustment on 32mm centers. Panels are drilled at front, rear, top, and bottom for embedding internal and external threaded bushings. Tops and bases are attached to end panels with 5/16" - 18 x 2" hex-head bolts and washers. Lag bolts or wood screws are not used.

INTERMEDIATE UPRIGHT PANELS AND TRANSITIONAL PANELS

Intermediate uprights are 1" thick thermally-fused laminate panels. All edges are banded with matching 2MM PVC edgebanding. Edges are square, but eased. Shelf pinholes are bored on both sides of the panel, but staggered so that pins can be deeply seated. Panels are drilled through at front, rear, top, and bottom for attachment of tops and bases with 5/16"-18 x 4-1/2" hex-head bolts, nuts, and washers.

BASE

The base front is 3-1/4"H X 3/4" thick thermally-fused laminate panel with a 3/4" thick base shelf. A full-length 2" x 3/4" rail is tenoned to the inside of the front. Bolting cleats 1-1/4" x 1-1/4" are glued and stapled perpendicular at the ends of the rail and drilled to allow assembly bolts to pass through. A second full-length rail is glued and stapled to the rear of the bolting cleats for support and proper alignment. Bases are manufactured so the base shelf rests on top of the base front.

ATTACHMENT

Four bolts are used to attach each single-faced base or top. Eight bolts are used to attach each double-faced base or top, except for 23"D double-faced units, on which sixteen bolts are used. All hardware is concealed from view after assembly. Hardware kits for attaching single-faced units to the wall are available upon request and are sold separately.

BACKS AND PARTITIONS

Backs and partitions are constructed with 1/4" thick thermally-fused laminate panels.

Note: Backs must be ordered separately.

STARTERS AND ADDERS

Starters and Adders include top, base, and shelves. Starters include one end panel, shelf pins and joining holes on inside only. Adders include one intermediate upright panel with shelf pins and joining holes on both sides. Finishing panels include shelf pins and joining holes on inside only.

Note: A finishing panel must be ordered separately to finish shelving.



Starter

Includes one end panel, shelf pins and joining holes on inside only. 37-3/16"W overall.

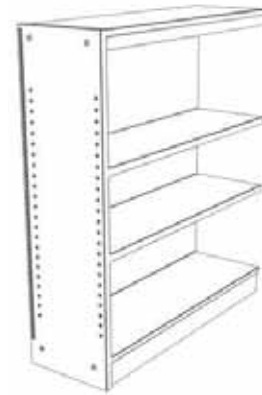

Adder

Includes one intermediate upright with shelf pins and joining holes on both sides. 36-3/16"W overall.



Finishing Panel

General Specifications – Tops and Towers

SHELVING TOPS

Cornice tops have a 1-1/2" fascia, constructed with 3/4" thick, thermally-fused laminate panel with matching 2MM PVC edgebanding, glued to a 3/4" thick thermally-fused laminate panel of specified depth. On the inside surface of the top at each end, butted to the fascia, is a solid hardwood bolting cleat 1-1/4" x 1-1/4" that is both glued and stapled. For additional strength, three 1-3/4" cleats are added at the intersection of the fascia and top panel. Bolting cleats are drilled to allow assembly bolts to pass through.

Note: Tops on 72"H units are inverted.

TRIANGLE TOWERS AND TRANSITIONAL TRIANGLE TOWERS

Triangle Towers are created using 1" thick, thermally-fused laminate panels. All edges are banded with matching 2mm PVC edgebanding. Edges are square, but eased. Vertical rows of holes are drilled near the front and rear of each panel for shelf adjustment on 32mm centers. Towers are assembled using 1-3/4" cleats attached to the inside of the tower panel. Panels are drilled at front, top, and bottom for embedding internal and external threaded bushings. Tops and bases are attached to triangle towers with 5/16" - 18 x 2" hex-head bolts and washers. Lag bolts or wood screws are not used.

General Specifications - Shelves & Mobile Units

LAMINATE SHELVES

Shelves are 3/4" thick, thermally-fused laminate, banded on front and back with matching 2MM PVC edgebanding. To ensure adequate support for heavy volumes, a 3/4" thick, 1-1/4"W support member is attached to the back edge of the bottom of each shelf. Adjustable shelves are notched 3/8"W x 3/16"H x 3/4"L on the underside to set firmly on 1" long, 5/16" diameter threaded shelf pins, cadmium-plated. Shelf depths are nominal.

MOBILE SHELVING UNITS

Mobile Shelving is available on 36", 42", 48", and 60-1/2" units. Shelving construction is the same as the standard shelving with the exception of the base; the base facing is 3-3/16"H. Four 2-1/2" diameter heavy-duty swivel casters attached to a 14 gauge caster bracket will be attached to the bottom of the unit with four #12 x 3/4" wood screws each. The caster assembly is hidden within the base, giving the appearance of standard unit.

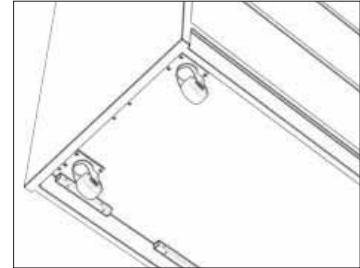

Bottom Caster View



Linear One Bay Mobile Unit



Linear Two Bay Mobile Unit

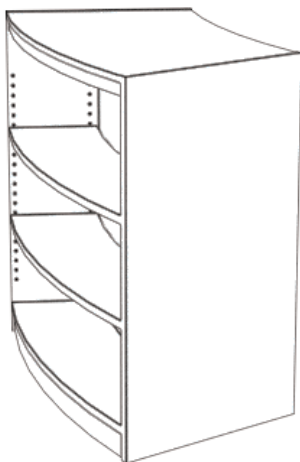

Arc One Bay Mobile Unit

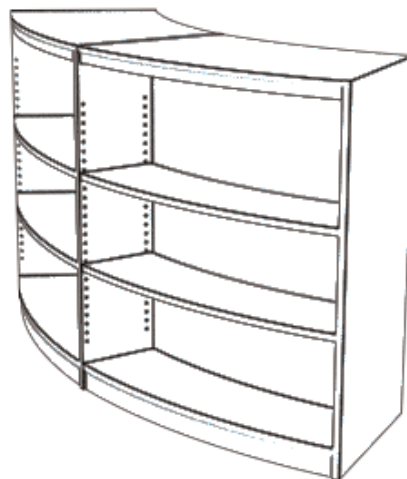

Arc Two Bay Mobile Unit

All Linear Single-Faced and Double-Faced, Starters and Adders.
 All Arc Single-Faced and Double-Faced, Starters and Adders.
 All Transitional Adders.

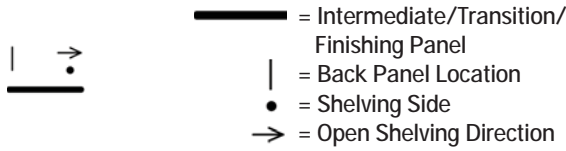

All Linear Single-Faced and Double-Faced, Tower Adders.
 All Arc Single-Faced and Double-Faced, Tower Adders.
 All Transitional Tower Adders.
 All Three-Way Towers.

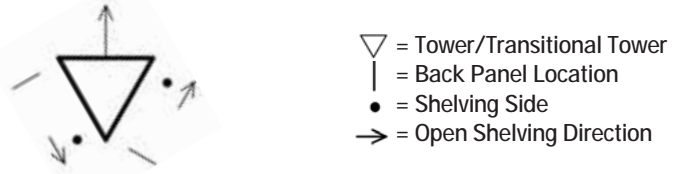

INLINE - Starter and adder back panels are on the same side of shelving units.

REVERSE - Starter and adder back panels are on the opposite side of shelving units.

TRANSITIONAL ADDERS/TOWER ADDERS - These are used when you are transitioning from a single-faced to double-faced unit, double-faced to single-faced unit, or single-faced unit to single-faced unit where the shelving units are positioned on opposite sides of the double-faced panel.

INNER SEATS - Inner seats are used on Convex Shelving.

OUTER SEATS - Outer seats are used on Concave Shelving.

SEATING - In some cases there will be two types of seating: Overlap End Panels and Inside End Panels.

Overlap End Panels Seating is used when you have a continuous run of seats that need to butt against each other to prevent a gap. They must overlap half of the edge of the end panel to achieve this. Inside End Panels Seating is used when you only need one seat or if the seat is used between two shelving units.

Note: These scenarios are labeled and depicted with images under each seating type in the seating section of the pricebook.

WHEN TO USE 37" WIDE CURVED SHELVING vs 44" WIDE CURVED SHELVING - 37" Wide Curved Shelving is used when you are transitioning from a curved Double-Faced unit to a Concave Single-Faced unit and the Single-Faced shelves are facing the inside of the curve. 44" Wide Curved Shelving is used when you are transitioning from a curved Double-Faced unit to a Single-Faced curved unit and the shelves are facing the outside of the curve.

37"W EXAMPLES:

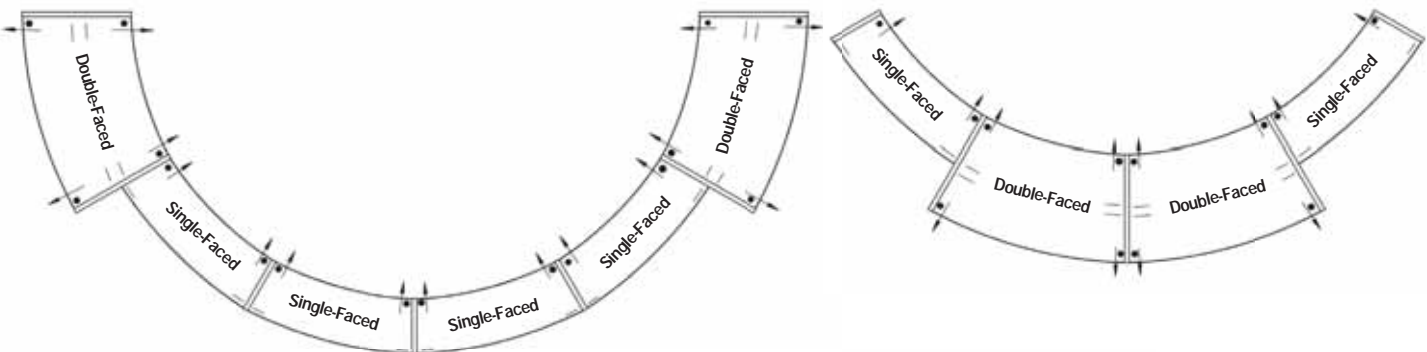

44"W EXAMPLE:

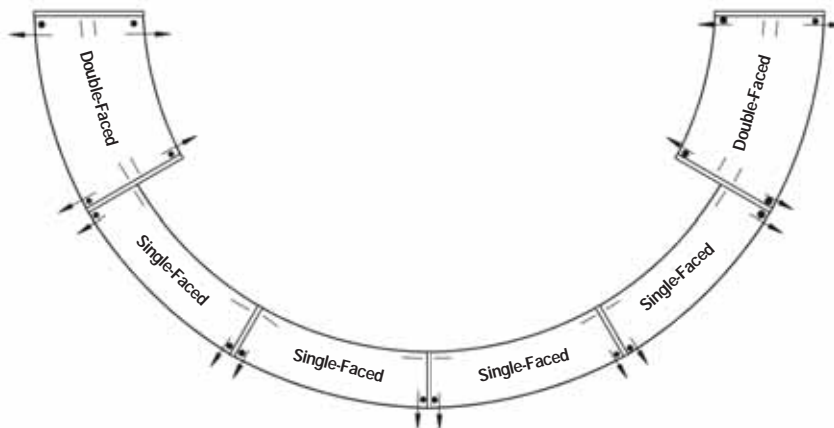

Oak Catalog No.	Maple Catalog No.	Laminate Catalog No.	H x W x D	Wt. (lbs.)	Oak Price	Maple Price	Laminate Price	
<i>2 Adjustable Shelves and 1 Base Shelf</i>								Single-Faced Starter Type 1
GEOLSS136OAKS	GEOLSS136MAPS	GEOLSS136LAMS	36" x 37-3/16" x 12"	63	\$ 670	\$ 703	\$501	
<i>2 Adjustable Shelves and 1 Base Shelf</i>								
GEOLSS142OAKS	GEOLSS142MAPS	GEOLSS142LAMS	42" x 37-3/16" x 12"	76	680	713	511	
GEOLSS148OAKS	GEOLSS148MAPS	GEOLSS148LAMS	48" x 37-3/16" x 12"	89	724	761	542	
<i>4 Adjustable Shelves and 1 Base Shelf</i>								
GEOLSS160OAKS	GEOLSS160MAPS	GEOLSS160LAMS	60-1/2" x 37-3/16" x 12"	99	949	996	710	
GEOLSS172OAKS	GEOLSS172MAPS	GEOLSS172LAMS	72" x 37-3/16" x 12"	107	1,009	1,060	756	
<i>2 Adjustable Shelves and 1 Base Shelf</i>								Single-Faced Starter Type 2
GEOLSS236OAKS	GEOLSS236MAPS	GEOLSS236LAMS	36" x 37-3/16" x 12"	63	\$ 670	\$ 703	\$501	
<i>2 Adjustable Shelves and 1 Base Shelf</i>								
GEOLSS242OAKS	GEOLSS242MAPS	GEOLSS242LAMS	42" x 37-3/16" x 12"	76	680	713	511	
GEOLSS248OAKS	GEOLSS248MAPS	GEOLSS248LAMS	48" x 37-3/16" x 12"	89	724	761	542	
<i>4 Adjustable Shelves and 1 Base Shelf</i>								
GEOLSS260OAKS	GEOLSS260MAPS	GEOLSS260LAMS	60-1/2" x 37-3/16" x 12"	99	949	996	710	
GEOLSS272OAKS	GEOLSS272MAPS	GEOLSS272LAMS	72" x 37-3/16" x 12"	107	1,009	1,060	756	
<i>2 Adjustable Shelves and 1 Base Shelf</i>								Single-Faced Inline Adder
GEOLSIA36OAKS	GEOLSIA36MAPS	GEOLSIA36LAMS	36" x 36-3/16" x 12"	63	\$ 670	\$ 703	\$501	
<i>2 Adjustable Shelves and 1 Base Shelf</i>								
GEOLSIA42OAKS	GEOLSIA42MAPS	GEOLSIA42LAMS	42" x 36-3/16" x 12"	76	680	713	511	
GEOLSIA48OAKS	GEOLSIA48MAPS	GEOLSIA48LAMS	48" x 36-3/16" x 12"	89	724	761	542	
<i>4 Adjustable Shelves and 1 Base Shelf</i>								
GEOLSIA60OAKS	GEOLSIA60MAPS	GEOLSIA60LAMS	60-1/2" x 36-3/16" x 12"	99	949	996	710	
GEOLSIA72OAKS	GEOLSIA72MAPS	GEOLSIA72LAMS	72" x 36-3/16" x 12"	107	1,009	1,060	756	
<i>2 Adjustable Shelves and 1 Base Shelf</i>								Single-Faced Reverse Adder Type 1
GEOLSRA136OAKS	GEOLSRA136MAPS	GEOLSRA136LAMS	36" x 36-3/16" x 12"	63	\$ 670	\$ 703	\$501	
<i>2 Adjustable Shelves and 1 Base Shelf</i>								
GEOLSRA142OAKS	GEOLSRA142MAPS	GEOLSRA142LAMS	42" x 36-3/16" x 12"	76	680	713	511	
GEOLSRA148OAKS	GEOLSRA148MAPS	GEOLSRA148LAMS	48" x 36-3/16" x 12"	89	724	761	542	
<i>4 Adjustable Shelves and 1 Base Shelf</i>								
GEOLSRA160OAKS	GEOLSRA160MAPS	GEOLSRA160LAMS	60-1/2" x 36-3/16" x 12"	99	949	996	710	
GEOLSRA172OAKS	GEOLSRA172MAPS	GEOLSRA172LAMS	72" x 36-3/16" x 12"	107	1,009	1,060	756	

Please specify Wood Finish (Table 1) or Laminate (Table 4). Details can be found on page GEN 4 and GEN 5.

Note: Shelving Finishing Panels are sold separately on page GEO 34. Shelving Back Panels are sold separately on pages GEO 37-GEO 46.

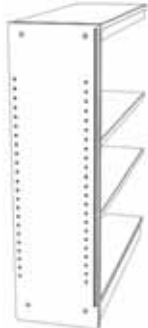
	Oak Catalog No.	Maple Catalog No.	Laminate Catalog No.	H x W x D	Wt. (lbs.)	Oak Price	Maple Price	Laminate Price
Single-Faced Reverse Adder Type 2 	<i>2 Adjustable Shelves and 1 Base Shelf</i>							
	GEOLSRA236OAKS	GEOLSRA236MAPS	GEOLSRA236LAMS	36" x 36-3/16" x 12"	63	\$ 670	\$ 703	\$501
	<i>2 Adjustable Shelves and 1 Base Shelf</i>							
	GEOLSRA242OAKS	GEOLSRA242MAPS	GEOLSRA242LAMS	42" x 36-3/16" x 12"	76	680	713	511
	GEOLSRA248OAKS	GEOLSRA248MAPS	GEOLSRA248LAMS	48" x 36-3/16" x 12"	89	724	761	542
	<i>4 Adjustable Shelves and 1 Base Shelf</i>							
	GEOLSRA260OAKS	GEOLSRA260MAPS	GEOLSRA260LAMS	60-1/2" x 36-3/16" x 12"	99	949	996	710
	GEOLSRA272OAKS	GEOLSRA272MAPS	GEOLSRA272LAMS	72" x 36-3/16" x 12"	107	1,009	1,060	756

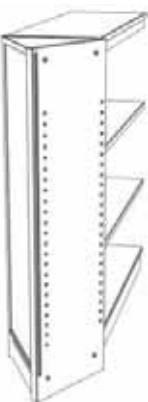
Single-Faced Inline Tower Adder Type 1 	<i>2 Adjustable Shelves and 1 Base Shelf</i>							
	GEOLSIT136OAKS	GEOLSIT136MAPS	GEOLSIT136LAMS	36" x 48-15/16" x 12"	79	\$1,082	\$1,136	\$ 810
	<i>2 Adjustable Shelves and 1 Base Shelf</i>							
	GEOLSIT142OAKS	GEOLSIT142MAPS	GEOLSIT142LAMS	42" x 48-15/16" x 12"	96	1,092	1,146	820
	GEOLSIT148OAKS	GEOLSIT148MAPS	GEOLSIT148LAMS	48" x 48-15/16" x 12"	109	1,163	1,222	871
	<i>4 Adjustable Shelves and 1 Base Shelf</i>							
	GEOLSIT160OAKS	GEOLSIT160MAPS	GEOLSIT160LAMS	60-1/2" x 48-15/16" x 12"	129	1,454	1,527	1,089
	GEOLSIT172OAKS	GEOLSIT172MAPS	GEOLSIT172LAMS	72" x 48-15/16" x 12"	137	1,469	1,543	1,101

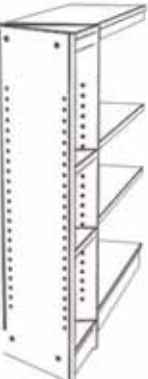
Single-Faced Inline Tower Adder Type 2 	<i>2 Adjustable Shelves and 1 Base Shelf</i>							
	GEOLSIT236OAKS	GEOLSIT236MAPS	GEOLSIT236LAMS	36" x 48-15/16" x 12"	79	\$1,159	\$1,218	\$ 868
	<i>2 Adjustable Shelves and 1 Base Shelf</i>							
	GEOLSIT242OAKS	GEOLSIT242MAPS	GEOLSIT242LAMS	42" x 48-15/16" x 12"	96	1,169	1,227	878
	GEOLSIT248OAKS	GEOLSIT248MAPS	GEOLSIT248LAMS	48" x 48-15/16" x 12"	109	1,239	1,302	928
	<i>4 Adjustable Shelves and 1 Base Shelf</i>							
	GEOLSIT260OAKS	GEOLSIT260MAPS	GEOLSIT260LAMS	60-1/2" x 48-15/16" x 12"	129	1,537	1,614	1,151
	GEOLSIT272OAKS	GEOLSIT272MAPS	GEOLSIT272LAMS	72" x 48-15/16" x 12"	137	1,546	1,623	1,159

Please specify Wood Finish (Table 1) or Laminate (Table 4). Details can be found on page GEN 4 and GEN 5.

Note: Shelving Finishing Panels are sold separately on page GEO 34. Shelving Back Panels are sold separately on pages GEO 37-GEO 46.

Oak Catalog No.	Maple Catalog No.	Laminate Catalog No.	H x W x D	Wt. (lbs.)	Oak Price	Maple Price	Laminate Price
-----------------	-------------------	----------------------	-----------	------------	-----------	-------------	----------------

2 Adjustable Shelves and 1 Base Shelf

GEOLSRT136OAKS	GEOLSRT136MAPS	GEOLSRT136LAMS	36" x 48-15/16" x 12"	79	\$1,159	\$1,218	\$ 868
----------------	----------------	----------------	-----------------------	----	---------	---------	--------

2 Adjustable Shelves and 1 Base Shelf

GEOLSRT142OAKS	GEOLSRT142MAPS	GEOLSRT142LAMS	42" x 48-15/16" x 12"	96	1,169	1,227	878
GEOLSRT148OAKS	GEOLSRT148MAPS	GEOLSRT148LAMS	48" x 48-15/16" x 12"	109	1,239	1,302	928

4 Adjustable Shelves and 1 Base Shelf

GEOLSRT160OAKS	GEOLSRT160MAPS	GEOLSRT160LAMS	60-1/2" x 48-15/16" x 12"	129	1,537	1,614	1,151
GEOLSRT172OAKS	GEOLSRT172MAPS	GEOLSRT172LAMS	72" x 48-15/16" x 12"	137	1,546	1,623	1,159

Single-Faced Reverse Tower Adder Type 1

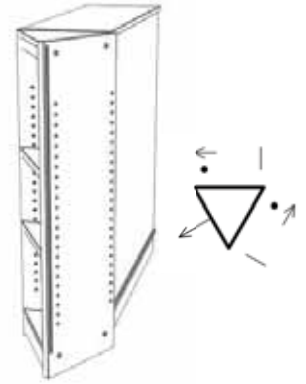

2 Adjustable Shelves and 1 Base Shelf

GEOLSRT236OAKS	GEOLSRT236MAPS	GEOLSRT236LAMS	36" x 48-15/16" x 12"	79	\$1,159	\$1,218	\$ 868
----------------	----------------	----------------	-----------------------	----	---------	---------	--------

2 Adjustable Shelves and 1 Base Shelf

GEOLSRT242OAKS	GEOLSRT242MAPS	GEOLSRT242LAMS	42" x 48-15/16" x 12"	96	1,169	1,227	878
GEOLSRT248OAKS	GEOLSRT248MAPS	GEOLSRT248LAMS	48" x 48-15/16" x 12"	109	1,239	1,302	928

4 Adjustable Shelves and 1 Base Shelf

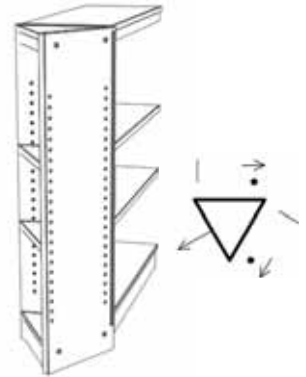

GEOLSRT260OAKS	GEOLSRT260MAPS	GEOLSRT260LAMS	60-1/2" x 48-15/16" x 12"	129	1,537	1,614	1,151
GEOLSRT272OAKS	GEOLSRT272MAPS	GEOLSRT272LAMS	72" x 48-15/16" x 12"	137	1,546	1,623	1,159

Single-Faced Reverse Tower Adder Type 2



Please specify Wood Finish (Table 1) or Laminate (Table 4). Details can be found on page GEN 4 and GEN 5.

Note: Shelving Finishing Panels are sold separately on page GEO 34. Shelving Back Panels are sold separately on pages GEO 37-GEO 46.

	Oak Catalog No.	Maple Catalog No.	Laminate Catalog No.	H x W x D	Wt. (lbs.)	Oak Price	Maple Price	Laminate Price
Double-Faced Starter  	<i>2 Adjustable Shelves and 1 Base Shelf</i>							
	GEOLDS36OAKS	GEOLDS36MAPS	GEOLDS36LAMAS	36" x 37-3/16" x 23"	118	\$1,398	\$1,469	\$1,047
	<i>2 Adjustable Shelves and 1 Base Shelf per Side</i>							
	GEOLDS42OAKS	GEOLDS42MAPS	GEOLDS42LAMAS	42" x 37-3/16" x 23"	140	1,409	1,479	1,056
	GEOLDS48OAKS	GEOLDS48MAPS	GEOLDS48LAMAS	48" x 37-3/16" x 23"	163	1,511	1,586	1,133
	<i>4 Adjustable Shelves and 1 Base Shelf per Side</i>							
	GEOLDS60OAKS	GEOLDS60MAPS	GEOLDS60LAMAS	60-1/2" x 37-3/16" x 23"	180	2,053	2,156	1,540
	GEOLDS72OAKS	GEOLDS72MAPS	GEOLDS72LAMAS	72" x 37-3/16" x 23"	194	2,369	2,488	1,777

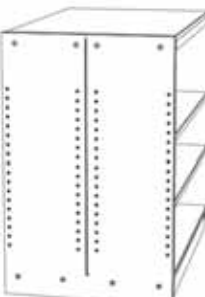
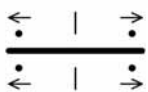
Double-Faced Inline Adder  	<i>2 Adjustable Shelves and 1 Base Shelf</i>							
	GEOLDIA36OAKS	GEOLDIA36MAPS	GEOLDIA36LAMAS	36" x 36-3/16" x 23"	118	\$1,398	\$1,469	\$1,047
	<i>2 Adjustable Shelves and 1 Base Shelf per Side</i>							
	GEOLDIA42OAKS	GEOLDIA42MAPS	GEOLDIA42LAMAS	42" x 36-3/16" x 23"	140	1,409	1,479	1,056
	GEOLDIA48OAKS	GEOLDIA48MAPS	GEOLDIA48LAMAS	48" x 36-3/16" x 23"	163	1,511	1,586	1,133
	<i>4 Adjustable Shelves and 1 Base Shelf per Side</i>							
	GEOLDIA60OAKS	GEOLDIA60MAPS	GEOLDIA60LAMAS	60-1/2" x 36-3/16" x 23"	180	2,053	2,156	1,540
	GEOLDIA72OAKS	GEOLDIA72MAPS	GEOLDIA72LAMAS	72" x 36-3/16" x 23"	194	2,369	2,488	1,777

Double-Faced Inline Tower Adder Type 1  	<i>2 Adjustable Shelves and 1 Base Shelf</i>							
	GEOLDIT136OAKS	GEOLDIT136MAPS	GEOLDIT136LAMAS	36" x 59-15/16" x 23"	156	\$2,158	\$2,266	\$1,617
	<i>2 Adjustable Shelves and 1 Base Shelf per Side</i>							
	GEOLDIT142OAKS	GEOLDIT142MAPS	GEOLDIT142LAMAS	42" x 59-15/16" x 23"	178	2,169	2,277	1,626
	GEOLDIT148OAKS	GEOLDIT148MAPS	GEOLDIT148LAMAS	48" x 59-15/16" x 23"	209	2,271	2,384	1,703
	<i>4 Adjustable Shelves and 1 Base Shelf per Side</i>							
	GEOLDIT160OAKS	GEOLDIT160MAPS	GEOLDIT160LAMAS	60-1/2" x 59-15/16" x 23"	236	2,807	2,947	2,105
	GEOLDIT172OAKS	GEOLDIT172MAPS	GEOLDIT172LAMAS	72" x 59-15/16" x 23"	266	3,030	3,182	2,273

Please specify Wood Finish (Table 1) or Laminate (Table 4). Details can be found on page GEN 4 and GEN 5.

Note: Shelving Finishing Panels are sold separately and are located on page GEO 34.

Oak Catalog No.	Maple Catalog No.	Laminate Catalog No.	H x W x D	Wt. (lbs.)	Oak Price	Maple Price	Laminate Price
-----------------	-------------------	----------------------	-----------	------------	-----------	-------------	----------------

2 Adjustable Shelves and 1 Base Shelf

GEOLDIT236OAKS	GEOLDIT236MAPS	GEOLDIT236LAMS	36" x 59-15/16" x 23"	156	\$2,158	\$2,266	\$1,617
----------------	----------------	----------------	-----------------------	-----	---------	---------	---------

2 Adjustable Shelves and 1 Base Shelf per Side

GEOLDIT242OAKS	GEOLDIT242MAPS	GEOLDIT242LAMS	42" x 59-15/16" x 23"	178	2,169	2,277	1,626
GEOLDIT248OAKS	GEOLDIT248MAPS	GEOLDIT248LAMS	48" x 59-15/16" x 23"	209	2,271	2,384	1,703

4 Adjustable Shelves and 1 Base Shelf per Side

GEOLDIT260OAKS	GEOLDIT260MAPS	GEOLDIT260LAMS	60-1/2" x 59-15/16" x 23"	236	2,807	2,947	2,105
GEOLDIT272OAKS	GEOLDIT272MAPS	GEOLDIT272LAMS	72" x 59-15/16" x 23"	266	3,030	3,182	2,273

Double-Faced Inline Tower Adder Type 2

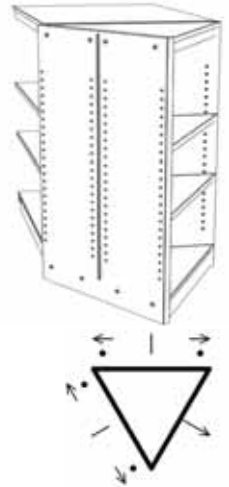

2 Adjustable Shelves and 1 Base Shelf

GEOLTSS136OAKS	GEOLTSS136MAPS	GEOLTSS136LAMS	36" x 36-3/16" x 23"	71	\$747	\$784	\$559
----------------	----------------	----------------	----------------------	----	-------	-------	-------

2 Adjustable Shelves and 1 Base Shelf

GEOLTSS142OAKS	GEOLTSS142MAPS	GEOLTSS142LAMS	42" x 36-3/16" x 23"	86	757	794	569
GEOLTSS148OAKS	GEOLTSS148MAPS	GEOLTSS148LAMS	48" x 36-3/16" x 23"	99	789	830	591

4 Adjustable Shelves and 1 Base Shelf

GEOLTSS160OAKS	GEOLTSS160MAPS	GEOLTSS160LAMS	60-1/2" x 36-3/16" x 23"	114	1,092	1,147	818
GEOLTSS172OAKS	GEOLTSS172MAPS	GEOLTSS172LAMS	72" x 36-3/16" x 23"	122	1,136	1,193	851

Transitional Adders, Type 1 Single- to Single-Faced



2 Adjustable Shelves and 1 Base Shelf

GEOLTSS236OAKS	GEOLTSS236MAPS	GEOLTSS236LAMS	36" x 36-3/16" x 23"	71	\$747	\$784	\$559
----------------	----------------	----------------	----------------------	----	-------	-------	-------

2 Adjustable Shelves and 1 Base Shelf

GEOLTSS242OAKS	GEOLTSS242MAPS	GEOLTSS242LAMS	42" x 36-3/16" x 23"	86	757	794	569
GEOLTSS248OAKS	GEOLTSS248MAPS	GEOLTSS248LAMS	48" x 36-3/16" x 23"	99	789	830	591

4 Adjustable Shelves and 1 Base Shelf

GEOLTSS260OAKS	GEOLTSS260MAPS	GEOLTSS260LAMS	60-1/2" x 36-3/16" x 23"	114	1,092	1,147	818
GEOLTSS272OAKS	GEOLTSS272MAPS	GEOLTSS272LAMS	72" x 36-3/16" x 23"	122	1,136	1,193	851

Transitional Adders, Type 2 Single- to Single-Faced



Please specify Wood Finish (Table 1) or Laminate (Table 4). Details can be found on page GEN 4 and GEN 5.

Note: Shelving Finishing Panels are sold separately on page GEO 34. Shelving Back Panels are sold separately on pages GEO 37-GEO 46.

Oak Catalog No.	Maple Catalog No.	Laminate Catalog No.	H x W x D	Wt. (lbs.)	Oak Price	Maple Price	Laminate Price
Transitional Adders, Type 1 Single- to Double-Faced							
<i>2 Adjustable Shelves and 1 Base Shelf per Side</i>							
GEOLTSD136OAKS	GEOLTSD136MAPS	GEOLTSD136LAMs	36" x 36-3/16" x 23"	118	\$1,398	\$1,469	\$1,047
<i>2 Adjustable Shelves and 1 Base Shelf per Side</i>							
GEOLTSD142OAKS	GEOLTSD142MAPS	GEOLTSD142LAMs	42" x 36-3/16" x 23"	140	1,409	1,479	1,056
GEOLTSD148OAKS	GEOLTSD148MAPS	GEOLTSD148LAMs	48" x 36-3/16" x 23"	163	1,511	1,586	1,133
<i>4 Adjustable Shelves and 1 Base Shelf per Side</i>							
GEOLTSD160OAKS	GEOLTSD160MAPS	GEOLTSD160LAMs	60-1/2" x 36-3/16" x 23"	180	2,053	2,156	1,540
GEOLTSD172OAKS	GEOLTSD172MAPS	GEOLTSD172LAMs	72" x 36-3/16" x 23"	194	2,369	2,488	1,777

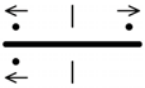

Transitional Adders, Type 2 Single- to Double-Faced							
<i>2 Adjustable Shelves and 1 Base Shelf per Side</i>							
GEOLTSD236OAKS	GEOLTSD236MAPS	GEOLTSD236LAMs	36" x 36-3/16" x 23"	118	\$1,398	\$1,469	\$1,047
<i>2 Adjustable Shelves and 1 Base Shelf per Side</i>							
GEOLTSD242OAKS	GEOLTSD242MAPS	GEOLTSD242LAMs	42" x 36-3/16" x 23"	140	1,409	1,479	1,056
GEOLTSD248OAKS	GEOLTSD248MAPS	GEOLTSD248LAMs	48" x 36-3/16" x 23"	163	1,511	1,586	1,133
<i>4 Adjustable Shelves and 1 Base Shelf per Side</i>							
GEOLTSD260OAKS	GEOLTSD260MAPS	GEOLTSD260LAMs	60-1/2" x 36-3/16" x 23"	180	2,053	2,156	1,540
GEOLTSD272OAKS	GEOLTSD272MAPS	GEOLTSD272LAMs	72" x 36-3/16" x 23"	194	2,369	2,488	1,777

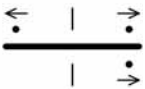

Transitional Adders, Type 1 Double- to Single-Faced							
<i>2 Adjustable Shelves and 1 Base Shelf</i>							
GEOLTDS136OAKS	GEOLTDS136MAPS	GEOLTDS136LAMs	36" x 36-3/16" x 23"	71	\$ 747	\$ 784	\$559
<i>2 Adjustable Shelves and 1 Base Shelf</i>							
GEOLTDS142OAKS	GEOLTDS142MAPS	GEOLTDS142LAMs	42" x 36-3/16" x 23"	86	757	794	569
GEOLTDS148OAKS	GEOLTDS148MAPS	GEOLTDS148LAMs	48" x 36-3/16" x 23"	99	789	830	591
<i>4 Adjustable Shelves and 1 Base Shelf</i>							
GEOLTDS160OAKS	GEOLTDS160MAPS	GEOLTDS160LAMs	60-1/2" x 36-3/16" x 23"	114	1,092	1,147	818
GEOLTDS172OAKS	GEOLTDS172MAPS	GEOLTDS172LAMs	72" x 36-3/16" x 23"	122	1,136	1,193	851

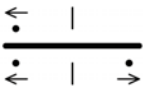

Please specify Wood Finish (Table 1) or Laminate (Table 4). Details can be found on page GEN 4 and GEN 5.

Note: Shelving Finishing Panels are sold separately on page GEO 34. Shelving Back Panels are sold separately on pages GEO 37-GEO 46.

Oak Catalog No.	Maple Catalog No.	Laminate Catalog No.	H x W x D	Wt. (lbs.)	Oak Price	Maple Price	Laminate Price
-----------------	-------------------	----------------------	-----------	------------	-----------	-------------	----------------

2 Adjustable Shelves and 1 Base Shelf

GEOLTDS236OAKS	GEOLTDS236MAPS	GEOLTDS136LAMS	36" x 36-3/16" x 23"	71	\$ 747	\$ 784	\$559
----------------	----------------	----------------	----------------------	----	--------	--------	-------

2 Adjustable Shelves and 1 Base Shelf

GEOLTDS242OAKS	GEOLTDS242MAPS	GEOLTDS142LAMS	42" x 36-3/16" x 23"	86	757	794	569
GEOLTDS248OAKS	GEOLTDS248MAPS	GEOLTDS148LAMS	48" x 36-3/16" x 23"	99	789	830	591

4 Adjustable Shelves and 1 Base Shelf

GEOLTDS260OAKS	GEOLTDS260MAPS	GEOLTDS160LAMS	60-1/2" x 36-3/16" x 23"	114	1,092	1,147	818
GEOLTDS272OAKS	GEOLTDS272MAPS	GEOLTDS172LAMS	72" x 36-3/16" x 23"	122	1,136	1,193	851

Transitional Adders, Type 2
Double- to Single-Faced



2 Adjustable Shelves and 1 Base Shelf per Side

GEOLTSD136OAKS	GEOLTSD136MAPS	GEOLTSD136LAMS	36" x 59-15/16" x 23"	156	\$2,158	\$2,266	\$1,617
----------------	----------------	----------------	-----------------------	-----	---------	---------	---------

2 Adjustable Shelves and 1 Base Shelf per Side

GEOLTSD142OAKS	GEOLTSD142MAPS	GEOLTSD142LAMS	42" x 59-15/16" x 23"	178	2,169	2,277	1,626
GEOLTSD148OAKS	GEOLTSD148MAPS	GEOLTSD148LAMS	48" x 59-15/16" x 23"	209	2,271	2,384	1,703

4 Adjustable Shelves and 1 Base Shelf per Side

GEOLTSD160OAKS	GEOLTSD160MAPS	GEOLTSD160LAMS	60-1/2" x 59-15/16" x 23"	236	2,807	2,947	2,105
GEOLTSD172OAKS	GEOLTSD172MAPS	GEOLTSD172LAMS	72" x 59-15/16" x 23"	266	3,030	3,182	2,273

Transitional Tower Adders,
Type 1 Single- to Double-Faced

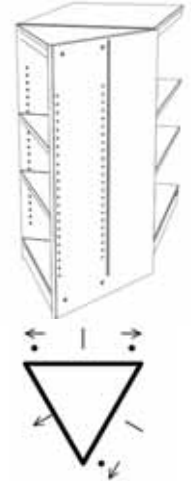

2 Adjustable Shelves and 1 Base Shelf per Side

GEOLTSD236OAKS	GEOLTSD236MAPS	GEOLTSD236LAMS	36" x 59-15/16" x 23"	156	\$2,158	\$2,266	\$1,617
----------------	----------------	----------------	-----------------------	-----	---------	---------	---------

2 Adjustable Shelves and 1 Base Shelf per Side

GEOLTSD242OAKS	GEOLTSD242MAPS	GEOLTSD242LAMS	42" x 59-15/16" x 23"	178	2,169	2,277	1,626
GEOLTSD248OAKS	GEOLTSD248MAPS	GEOLTSD248LAMS	48" x 59-15/16" x 23"	209	2,271	2,384	1,703

4 Adjustable Shelves and 1 Base Shelf per Side

GEOLTSD260OAKS	GEOLTSD260MAPS	GEOLTSD260LAMS	60-1/2" x 59-15/16" x 23"	236	2,807	2,947	2,105
GEOLTSD272OAKS	GEOLTSD272MAPS	GEOLTSD272LAMS	72" x 59-15/16" x 23"	266	3,030	3,182	2,273

Transitional Tower Adders,
Type 2 Single- to Double-Faced

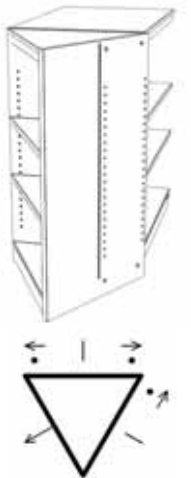

Please specify Wood Finish (Table 1) or Laminate (Table 4). Details can be found on page GEN 4 and GEN 5.

Note: Shelving Finishing Panels are sold separately on page GEO 34. Shelving Back Panels are sold separately on pages GEO 37-GEO 46.

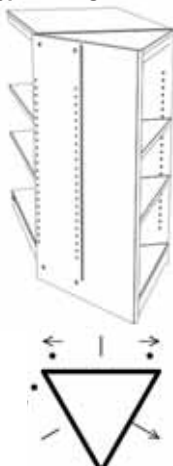
	Oak Catalog No.	Maple Catalog No.	Laminate Catalog No.	H x W x D	Wt. (lbs.)	Oak Price	Maple Price	Laminate Price
Transitional Tower Adders, Type 3 Single- to Double-Faced 	<i>2 Adjustable Shelves and 1 Base Shelf per Side</i>							
	GEOLTTSD336OAKS	GEOLTTSD336MAPS	GEOLTTSD336LAMAS	36" x 59-15/16" x 23"	156	\$2,158	\$2,266	\$1,617
	<i>2 Adjustable Shelves and 1 Base Shelf per Side</i>							
	GEOLTTSD342OAKS	GEOLTTSD342MAPS	GEOLTTSD342LAMAS	42" x 59-15/16" x 23"	178	2,169	2,277	1,626
	GEOLTTSD348OAKS	GEOLTTSD348MAPS	GEOLTTSD348LAMAS	48" x 59-15/16" x 23"	209	2,271	2,384	1,703
	<i>4 Adjustable Shelves and 1 Base Shelf per Side</i>							
	GEOLTTSD360OAKS	GEOLTTSD360MAPS	GEOLTTSD360LAMAS	60-1/2" x 59-15/16" x 23"	236	2,807	2,947	2,105
	GEOLTTSD372OAKS	GEOLTTSD372MAPS	GEOLTTSD372LAMAS	72" x 59-15/16" x 23"	266	3,030	3,182	2,273

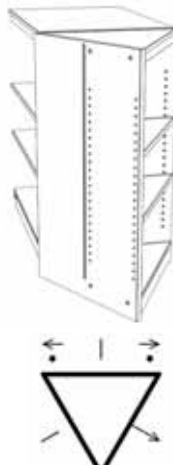
Transitional Tower Adders, Type 4 Single- to Double-Faced 	<i>2 Adjustable Shelves and 1 Base Shelf per Side</i>							
	GEOLTTSD436OAKS	GEOLTTSD436MAPS	GEOLTTSD436LAMAS	36" x 59-15/16" x 23"	156	\$2,158	\$2,266	\$1,617
	<i>2 Adjustable Shelves and 1 Base Shelf per Side</i>							
	GEOLTTSD442OAKS	GEOLTTSD442MAPS	GEOLTTSD442LAMAS	42" x 59-15/16" x 23"	178	2,169	2,277	1,626
	GEOLTTSD448OAKS	GEOLTTSD448MAPS	GEOLTTSD448LAMAS	48" x 59-15/16" x 23"	209	2,271	2,384	1,703
	<i>4 Adjustable Shelves and 1 Base Shelf per Side</i>							
	GEOLTTSD460OAKS	GEOLTTSD460MAPS	GEOLTTSD460LAMAS	60-1/2" x 59-15/16" x 23"	236	2,807	2,947	2,105
	GEOLTTSD472OAKS	GEOLTTSD472MAPS	GEOLTTSD472LAMAS	72" x 59-15/16" x 23"	266	3,030	3,182	2,273

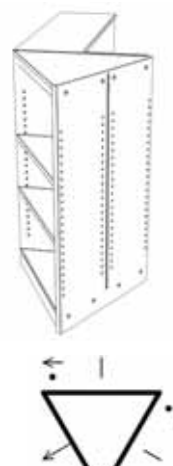
Transitional Tower Adders, Type 1 Double- to Single-Faced 	<i>2 Adjustable Shelves and 1 Base Shelf</i>							
	GEOLTTDS136OAKS	GEOLTTDS136MAPS	GEOLTTDS136LAMAS	36" x 59-15/16" x 23"	101	\$1,563	\$1,641	\$1,171
	<i>2 Adjustable Shelves and 1 Base Shelf</i>							
	GEOLTTDS142OAKS	GEOLTTDS142MAPS	GEOLTTDS142LAMAS	42" x 59-15/16" x 23"	112	1,573	1,651	1,181
	GEOLTTDS148OAKS	GEOLTTDS148MAPS	GEOLTTDS148LAMAS	48" x 59-15/16" x 23"	135	1,609	1,690	1,205
	<i>4 Adjustable Shelves and 1 Base Shelf</i>							
	GEOLTTDS160OAKS	GEOLTTDS160MAPS	GEOLTTDS160LAMAS	60-1/2" x 59-15/16" x 23"	155	1,980	2,079	1,483
	GEOLTTDS172OAKS	GEOLTTDS172MAPS	GEOLTTDS172LAMAS	72" x 59-15/16" x 23"	179	2,044	2,147	1,533

Please specify Wood Finish (Table 1) or Laminate (Table 4). Details can be found on page GEN 4 and GEN 5.

Living Finishing Panels are sold separately on page GEO 34. Shelving Back Panels are sold separately on pages GEO 37-GEO 46.

Oak Catalog No.	Maple Catalog No.	Laminate Catalog No.	H x W x D	Wt. (lbs.)	Oak Price	Maple Price	Laminate Price
-----------------	-------------------	----------------------	-----------	------------	-----------	-------------	----------------

2 Adjustable Shelves and 1 Base Shelf

GEOLTDS236OAKS	GEOLTDS236MAPS	GEOLTDS236LAMS	36" x 59-15/16" x 23"	101	\$1,563	\$1,641	\$1,171
----------------	----------------	----------------	-----------------------	-----	---------	---------	---------

2 Adjustable Shelves and 1 Base Shelf

GEOLTDS242OAKS	GEOLTDS242MAPS	GEOLTDS242LAMS	42" x 59-15/16" x 23"	112	1,573	1,651	1,181
GEOLTDS248OAKS	GEOLTDS248MAPS	GEOLTDS248LAMS	48" x 59-15/16" x 23"	135	1,609	1,690	1,205

4 Adjustable Shelves and 1 Base Shelf

GEOLTDS260OAKS	GEOLTDS260MAPS	GEOLTDS260LAMS	60-1/2" x 59-15/16" x 23"	155	1,980	2,079	1,483
GEOLTDS272OAKS	GEOLTDS272MAPS	GEOLTDS272LAMS	72" x 59-15/16" x 23"	179	2,044	2,147	1,533

Transitional Tower Adders, Type 2 Double- to Single-Faced

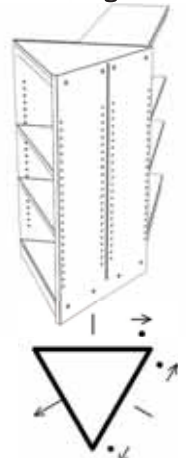

2 Adjustable Shelves and 1 Base Shelf

GEOLTDS336OAKS	GEOLTDS336MAPS	GEOLTDS336LAMS	36" x 59-15/16" x 23"	101	\$1,563	\$1,641	\$1,171
----------------	----------------	----------------	-----------------------	-----	---------	---------	---------

2 Adjustable Shelves and 1 Base Shelf

GEOLTDS342OAKS	GEOLTDS342MAPS	GEOLTDS342LAMS	42" x 59-15/16" x 23"	112	1,573	1,651	1,181
GEOLTDS348OAKS	GEOLTDS348MAPS	GEOLTDS348LAMS	48" x 59-15/16" x 23"	135	1,609	1,690	1,205

4 Adjustable Shelves and 1 Base Shelf

GEOLTDS360OAKS	GEOLTDS360MAPS	GEOLTDS360LAMS	60-1/2" x 59-15/16" x 23"	155	1,980	2,079	1,483
GEOLTDS372OAKS	GEOLTDS372MAPS	GEOLTDS372LAMS	72" x 59-15/16" x 23"	179	2,044	2,147	1,533

Transitional Tower Adders, Type 3 Double- to Single-Faced

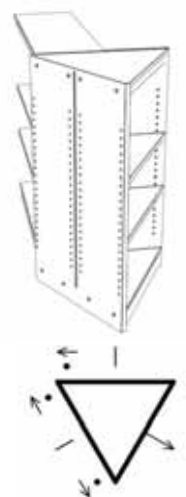

2 Adjustable Shelves and 1 Base Shelf

GEOLTDS436OAKS	GEOLTDS436MAPS	GEOLTDS436LAMS	36" x 59-15/16" x 23"	101	\$1,563	\$1,641	\$1,171
----------------	----------------	----------------	-----------------------	-----	---------	---------	---------

2 Adjustable Shelves and 1 Base Shelf

GEOLTDS442OAKS	GEOLTDS442MAPS	GEOLTDS442LAMS	42" x 59-15/16" x 23"	112	1,573	1,651	1,181
GEOLTDS448OAKS	GEOLTDS448MAPS	GEOLTDS448LAMS	48" x 59-15/16" x 23"	135	1,609	1,690	1,205

4 Adjustable Shelves and 1 Base Shelf

GEOLTDS460OAKS	GEOLTDS460MAPS	GEOLTDS460LAMS	60-1/2" x 59-15/16" x 23"	155	1,980	2,079	1,483
GEOLTDS472OAKS	GEOLTDS472MAPS	GEOLTDS472LAMS	72" x 59-15/16" x 23"	179	2,044	2,147	1,533

Transitional Tower Adders, Type 4 Double- to Single-Faced

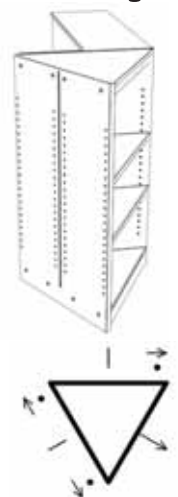

Please specify Wood Finish (Table 1) or Laminate (Table 4). Details can be found on page GEN 4 and GEN 5.

Note: Shelving Finishing Panels are sold separately on page GEO 34. Shelving Back Panels are sold separately on pages GEO 37-GEO 46.

	Oak Catalog No.	Maple Catalog No.	Laminate Catalog No.	H x W x D	Wt. (lbs.)	Oak Price	Maple Price	Laminate Price
Convex Single-Faced Starter Type 1 	<i>2 Adjustable Shelves and 1 Base Shelf</i>							
	GEOAXSS136OAKS	GEOAXSS136MAPS	GEOAXSS136LAMAS	36" x 44" x 12"	75	\$ 993	\$1,043	\$ 857
	<i>2 Adjustable Shelves and 1 Base Shelf</i>							
	GEOAXSS142OAKS	GEOAXSS142MAPS	GEOAXSS142LAMAS	42" x 44" x 12"	88	1,003	1,053	866
	GEOAXSS148OAKS	GEOAXSS148MAPS	GEOAXSS148LAMAS	48" x 44" x 12"	101	1,069	1,123	923
	<i>4 Adjustable Shelves and 1 Base Shelf</i>							
	GEOAXSS160OAKS	GEOAXSS160MAPS	GEOAXSS160LAMAS	60-1/2" x 44" x 12"	111	1,411	1,482	1,218
	GEOAXSS172OAKS	GEOAXSS172MAPS	GEOAXSS172LAMAS	72" x 44" x 12"	119	1,503	1,578	1,299

Convex Single-Faced Starter Type 2 	<i>2 Adjustable Shelves and 1 Base Shelf</i>							
	GEOAXSS236OAKS	GEOAXSS236MAPS	GEOAXSS236LAMAS	36" x 44" x 12"	75	\$ 993	\$1,043	\$ 857
	<i>2 Adjustable Shelves and 1 Base Shelf</i>							
	GEOAXSS242OAKS	GEOAXSS242MAPS	GEOAXSS242LAMAS	42" x 44" x 12"	88	1,003	1,053	866
	GEOAXSS248OAKS	GEOAXSS248MAPS	GEOAXSS248LAMAS	48" x 44" x 12"	101	1,069	1,123	923
	<i>4 Adjustable Shelves and 1 Base Shelf</i>							
	GEOAXSS260OAKS	GEOAXSS260MAPS	GEOAXSS260LAMAS	60-1/2" x 44" x 12"	111	1,411	1,482	1,218
	GEOAXSS272OAKS	GEOAXSS272MAPS	GEOAXSS272LAMAS	72" x 44" x 12"	119	1,503	1,578	1,299

Convex Single-Faced Inline Adder 	<i>2 Adjustable Shelves and 1 Base Shelf</i>							
	GEOAXSIA36OAKS	GEOAXSIA36MAPS	GEOAXSIA36LAMAS	36" x 44" x 12"	75	\$ 993	\$1,043	\$ 857
	<i>2 Adjustable Shelves and 1 Base Shelf</i>							
	GEOAXSIA42OAKS	GEOAXSIA42MAPS	GEOAXSIA42LAMAS	42" x 44" x 12"	88	1,003	1,053	866
	GEOAXSIA48OAKS	GEOAXSIA48MAPS	GEOAXSIA48LAMAS	48" x 44" x 12"	101	1,069	1,123	923
	<i>4 Adjustable Shelves and 1 Base Shelf</i>							
	GEOAXSIA60OAKS	GEOAXSIA60MAPS	GEOAXSIA60LAMAS	60-1/2" x 44" x 12"	111	1,411	1,482	1,218
	GEOAXSIA72OAKS	GEOAXSIA72MAPS	GEOAXSIA72LAMAS	72" x 44" x 12"	119	1,503	1,578	1,299

Please specify Wood Finish (Table 1) or Laminate (Table 4). Details can be found on page GEN 4 and GEN 5.

Note: Shelving Finishing Panels are sold separately on page GEO 34. Shelving Back Panels are sold separately on pages GEO 37-GEO 46.

Oak Catalog No.	Maple Catalog No.	Laminate Catalog No.	H x W x D	Wt. (lbs.)	Oak Price	Maple Price	Laminate Price
-----------------	-------------------	----------------------	-----------	------------	-----------	-------------	----------------

2 Adjustable Shelves and 1 Base Shelf

GEOAXSRA136OAKS	GEOAXSRA136MAPS	GEOAXSRA136LAMS	36" x 44" x 12"	75	\$ 993	\$1,043	\$ 857
-----------------	-----------------	-----------------	-----------------	----	--------	---------	--------

Convex Single-Faced Reverse Adder Type 1

2 Adjustable Shelves and 1 Base Shelf

GEOAXSRA142OAKS	GEOAXSRA142MAPS	GEOAXSRA142LAMS	42" x 44" x 12"	88	1,003	1,053	866
GEOAXSRA148OAKS	GEOAXSRA148MAPS	GEOAXSRA148LAMS	48" x 44" x 12"	101	1,069	1,123	923

4 Adjustable Shelves and 1 Base Shelf

GEOAXSRA160OAKS	GEOAXSRA160MAPS	GEOAXSRA160LAMS	60-1/2" x 44" x 12"	111	1,411	1,482	1,218
GEOAXSRA172OAKS	GEOAXSRA172MAPS	GEOAXSRA172LAMS	72" x 44" x 12"	119	1,503	1,578	1,299

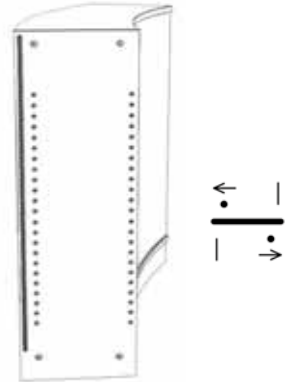

2 Adjustable Shelves and 1 Base Shelf

GEOAXSRA236OAKS	GEOAXSRA236MAPS	GEOAXSRA236LAMS	36" x 44" x 12"	75	\$ 993	\$1,043	\$ 857
-----------------	-----------------	-----------------	-----------------	----	--------	---------	--------

Convex Single-Faced Reverse Adder Type 2

2 Adjustable Shelves and 1 Base Shelf

GEOAXSRA242OAKS	GEOAXSRA242MAPS	GEOAXSRA242LAMS	42" x 44" x 12"	88	1,003	1,053	866
GEOAXSRA248OAKS	GEOAXSRA248MAPS	GEOAXSRA248LAMS	48" x 44" x 12"	101	1,069	1,123	923

4 Adjustable Shelves and 1 Base Shelf

GEOAXSRA260OAKS	GEOAXSRA260MAPS	GEOAXSRA260LAMS	60-1/2" x 44" x 12"	111	1,411	1,482	1,218
GEOAXSRA272OAKS	GEOAXSRA272MAPS	GEOAXSRA272LAMS	72" x 44" x 12"	119	1,503	1,578	1,299

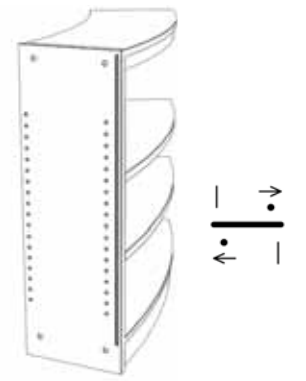

Please specify Wood Finish (Table 1) or Laminate (Table 4). Details can be found on page GEN 4 and GEN 5.

Note: Shelving Finishing Panels are sold separately on page GEO 34. Shelving Back Panels are sold separately on pages GEO 37-GEO 46.

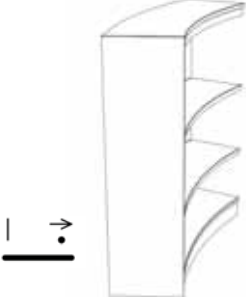
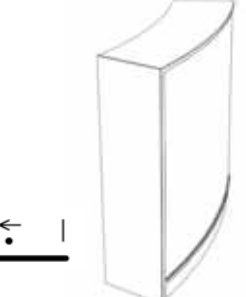
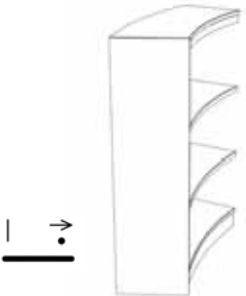
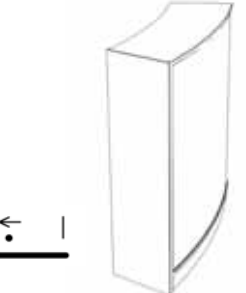
	Oak Catalog No.	Maple Catalog No.	Laminate Catalog No.	H x W x D	Wt. (lbs.)	Oak Price	Maple Price	Laminate Price	
	<i>2 Adjustable Shelves and 1 Base Shelf</i>								
	GEOAVSS136OAKS	GEOAVSS136MAPS	GEOAVSS136LAMs	36" x 44" x 12"	75	\$ 993	\$1,043	\$ 857	
	<i>2 Adjustable Shelves and 1 Base Shelf</i>								
	GEOAVSS142OAKS	GEOAVSS142MAPS	GEOAVSS142LAMs	42" x 44" x 12"	88	1,033	1,053	866	
	GEOAVSS148OAKS	GEOAVSS148MAPS	GEOAVSS148LAMs	48" x 44" x 12"	101	1,069	1,123	923	
	<i>4 Adjustable Shelves and 1 Base Shelf</i>								
	GEOAVSS160OAKS	GEOAVSS160MAPS	GEOAVSS160LAMs	60-1/2" x 44" x 12"	111	1,411	1,482	1,218	
	GEOAVSS172OAKS	GEOAVSS172MAPS	GEOAVSS172LAMs	72" x 44" x 12"	119	1,503	1,578	1,299	
		<i>2 Adjustable Shelves and 1 Base Shelf</i>							
		GEOAVSS236OAKS	GEOAVSS236MAPS	GEOAVSS236LAMs	36" x 44" x 12"	75	\$ 993	\$1,043	\$ 857
<i>2 Adjustable Shelves and 1 Base Shelf</i>									
GEOAVSS242OAKS		GEOAVSS242MAPS	GEOAVSS242LAMs	42" x 44" x 12"	88	1,033	1,053	866	
GEOAVSS248OAKS		GEOAVSS248MAPS	GEOAVSS248LAMs	48" x 44" x 12"	101	1,069	1,123	923	
<i>4 Adjustable Shelves and 1 Base Shelf</i>									
GEOAVSS260OAKS		GEOAVSS260MAPS	GEOAVSS260LAMs	60-1/2" x 44" x 12"	111	1,411	1,482	1,218	
GEOAVSS272OAKS		GEOAVSS272MAPS	GEOAVSS272LAMs	72" x 44" x 12"	119	1,503	1,578	1,299	
		<i>2 Adjustable Shelves and 1 Base Shelf</i>							
		GEOAVSS336OAKS	GEOAVSS336MAPS	GEOAVSS336LAMs	36" x 37" x 12"	63	\$ 993	\$1,043	\$ 857
	<i>2 Adjustable Shelves and 1 Base Shelf</i>								
	GEOAVSS342OAKS	GEOAVSS342MAPS	GEOAVSS342LAMs	42" x 37" x 12"	76	1,003	1,053	866	
	GEOAVSS348OAKS	GEOAVSS348MAPS	GEOAVSS348LAMs	48" x 37" x 12"	89	1,069	1,123	923	
	<i>4 Adjustable Shelves and 1 Base Shelf</i>								
	GEOAVSS360OAKS	GEOAVSS360MAPS	GEOAVSS360LAMs	60-1/2" x 37" x 12"	99	1,411	1,482	1,218	
	GEOAVSS372OAKS	GEOAVSS372MAPS	GEOAVSS372LAMs	72" x 37" x 12"	107	1,503	1,578	1,299	
		<i>2 Adjustable Shelves and 1 Base Shelf</i>							
		GEOAVSS436OAKS	GEOAVSS436MAPS	GEOAVSS436LAMs	36" x 37" x 12"	63	\$ 993	\$1,043	\$ 857
<i>2 Adjustable Shelves and 1 Base Shelf</i>									
GEOAVSS442OAKS		GEOAVSS442MAPS	GEOAVSS442LAMs	42" x 37" x 12"	76	1,003	1,053	866	
GEOAVSS448OAKS		GEOAVSS448MAPS	GEOAVSS448LAMs	48" x 37" x 12"	89	1,069	1,123	923	
<i>4 Adjustable Shelves and 1 Base Shelf</i>									
GEOAVSS460OAKS		GEOAVSS460MAPS	GEOAVSS460LAMs	60-1/2" x 37" x 12"	99	1,411	1,482	1,218	
GEOAVSS472OAKS		GEOAVSS472MAPS	GEOAVSS472LAMs	72" x 37" x 12"	107	1,503	1,578	1,299	



Please specify Wood Finish (Table 1) or Laminate (Table 4). Details can be found on page GEN 4 and GEN 5.

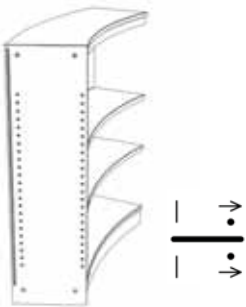
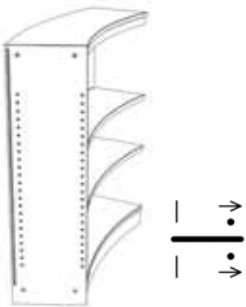
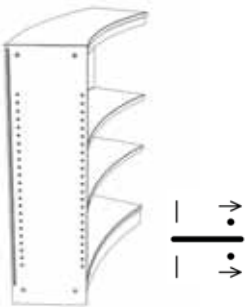
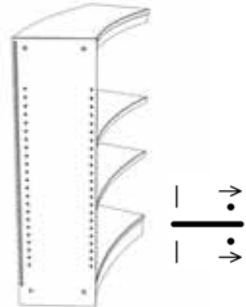
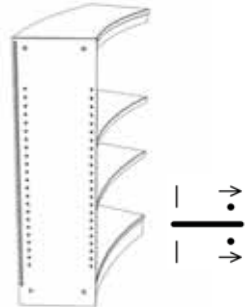
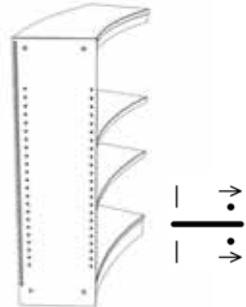
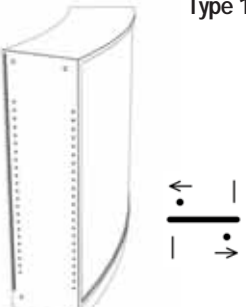
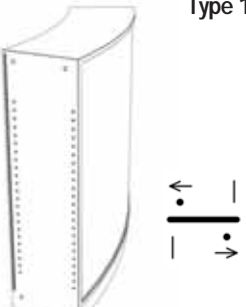
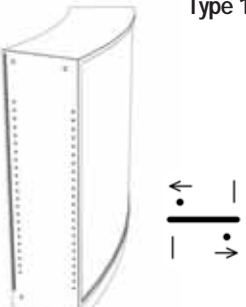
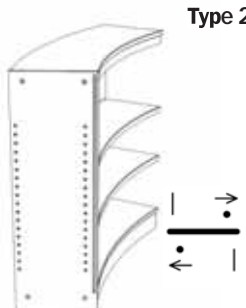
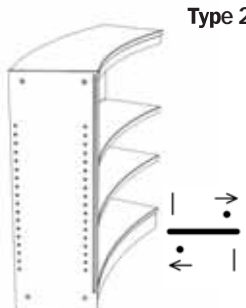
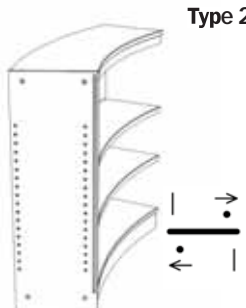

Note: Shelving Finishing Panels are sold separately on page GEO 34. Shelving Back Panels are sold separately on pages GEO 37-GEO 46.

Oak Catalog No.	Maple Catalog No.	Laminate Catalog No.	H x W x D	Wt. (lbs.)	Oak Price	Maple Price	Laminate Price	
<u>2 Adjustable Shelves and 1 Base Shelf</u>								<p>Concave Single-Faced 44" Wide Inline Adder Type 1</p> 
GEOAVSIA136OAKS	GEOAVSIA136MAPS	GEOAVSIA136LAMS	36" x 44" x 12"	75	\$ 993	\$1,043	\$ 857	
<u>2 Adjustable Shelves and 1 Base Shelf</u>								<p>Concave Single-Faced 44" Wide Inline Adder Type 1</p> 
GEOAVSIA142OAKS	GEOAVSIA142MAPS	GEOAVSIA142LAMS	42" x 44" x 12"	88	1,003	1,053	866	
GEOAVSIA148OAKS	GEOAVSIA148MAPS	GEOAVSIA148LAMS	48" x 44" x 12"	101	1,069	1,123	923	
<u>4 Adjustable Shelves and 1 Base Shelf</u>								<p>Concave Single-Faced 44" Wide Inline Adder Type 1</p> 
GEOAVSIA160OAKS	GEOAVSIA160MAPS	GEOAVSIA160LAMS	60-1/2" x 44" x 12"	111	1,411	1,482	1,218	
GEOAVSIA172OAKS	GEOAVSIA172MAPS	GEOAVSIA172LAMS	72" x 44" x 12"	119	1,503	1,578	1,299	
<u>2 Adjustable Shelves and 1 Base Shelf</u>								<p>Concave Single-Faced 37" Wide Inline Adder Type 2</p> 
GEOAVSIA236OAKS	GEOAVSIA236MAPS	GEOAVSIA236LAMS	36" x 37" x 12"	63	\$ 993	\$1,043	\$ 857	
<u>2 Adjustable Shelves and 1 Base Shelf</u>								<p>Concave Single-Faced 37" Wide Inline Adder Type 2</p> 
GEOAVSIA242OAKS	GEOAVSIA242MAPS	GEOAVSIA242LAMS	42" x 37" x 12"	76	1,003	1,053	866	
GEOAVSIA248OAKS	GEOAVSIA248MAPS	GEOAVSIA248LAMS	48" x 37" x 12"	89	1,069	1,123	923	
<u>4 Adjustable Shelves and 1 Base Shelf</u>								<p>Concave Single-Faced 37" Wide Inline Adder Type 2</p> 
GEOAVSIA260OAKS	GEOAVSIA260MAPS	GEOAVSIA260LAMS	60-1/2" x 37" x 12"	99	1,411	1,482	1,218	
GEOAVSIA272OAKS	GEOAVSIA272MAPS	GEOAVSIA272LAMS	72" x 37" x 12"	107	1,503	1,578	1,299	
<u>2 Adjustable Shelves and 1 Base Shelf</u>								<p>Concave Single-Faced 44" Wide Reverse Adder Type 1</p> 
GEOAVSRA136OAKS	GEOAVSRA136MAPS	GEOAVSRA136LAMS	36" x 44" x 12"	75	\$ 993	\$1,043	\$ 857	
<u>2 Adjustable Shelves and 1 Base Shelf</u>								<p>Concave Single-Faced 44" Wide Reverse Adder Type 1</p> 
GEOAVSRA142OAKS	GEOAVSRA142MAPS	GEOAVSRA142LAMS	42" x 44" x 12"	88	1,003	1,053	866	
GEOAVSRA148OAKS	GEOAVSRA148MAPS	GEOAVSRA148LAMS	48" x 44" x 12"	101	1,069	1,123	923	
<u>4 Adjustable Shelves and 1 Base Shelf</u>								<p>Concave Single-Faced 44" Wide Reverse Adder Type 1</p> 
GEOAVSRA160OAKS	GEOAVSRA160MAPS	GEOAVSRA160LAMS	60-1/2" x 44" x 12"	111	1,411	1,482	1,218	
GEOAVSRA172OAKS	GEOAVSRA172MAPS	GEOAVSRA172LAMS	72" x 44" x 12"	119	1,503	1,578	1,299	
<u>2 Adjustable Shelves and 1 Base Shelf</u>								<p>Concave Single-Faced 44" Wide Reverse Adder Type 2</p> 
GEOAVSRA236OAKS	GEOAVSRA236MAPS	GEOAVSRA236LAMS	36" x 44" x 12"	75	\$ 993	\$1,043	\$ 857	
<u>2 Adjustable Shelves and 1 Base Shelf</u>								<p>Concave Single-Faced 44" Wide Reverse Adder Type 2</p> 
GEOAVSRA242OAKS	GEOAVSRA242MAPS	GEOAVSRA242LAMS	42" x 44" x 12"	88	1,003	1,053	866	
GEOAVSRA248OAKS	GEOAVSRA248MAPS	GEOAVSRA248LAMS	48" x 44" x 12"	101	1,069	1,123	923	
<u>4 Adjustable Shelves and 1 Base Shelf</u>								<p>Concave Single-Faced 44" Wide Reverse Adder Type 2</p> 
GEOAVSRA260OAKS	GEOAVSRA260MAPS	GEOAVSRA260LAMS	60-1/2" x 44" x 12"	111	1,411	1,482	1,218	
GEOAVSRA272OAKS	GEOAVSRA272MAPS	GEOAVSRA272LAMS	72" x 44" x 12"	119	1,503	1,578	1,299	

Please specify Wood Finish (Table 1) or Laminate (Table 4). Details can be found on page GEN 4 and GEN 5.



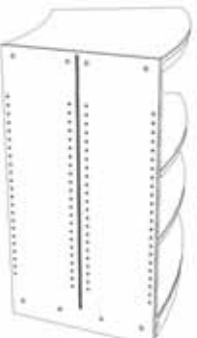



Note: Shelving Finishing Panels are sold separately on page GEO 34. Shelving Back Panels are sold separately on pages GEO 37-GEO 46.

	Oak Catalog No.	Maple Catalog No.	Laminate Catalog No.	H x W x D	Wt. (lbs.)	Oak Price	Maple Price	Laminate Price
Double-Faced 44" Wide Starter  	<i>2 Adjustable Shelves and 1 Base Shelf per Side</i>							
	GEOADS36OAKS	GEOADS36MAPS	GEOADS36LAMS	36" x 44" x 23"	142	\$1,962	\$2,061	\$1,667
	<i>2 Adjustable Shelves and 1 Base Shelf per Side</i>							
	GEOADS42OAKS	GEOADS42MAPS	GEOADS42LAMS	42" x 44" x 23"	166	1,973	2,071	1,677
	GEOADS48OAKS	GEOADS48MAPS	GEOADS48LAMS	48" x 44" x 23"	190	2,125	2,231	1,806
	<i>4 Adjustable Shelves and 1 Base Shelf per Side</i>							
	GEOADS60OAKS	GEOADS60MAPS	GEOADS60LAMS	60-1/2" x 44" x 23"	210	2,572	2,701	2,187
	GEOADS72OAKS	GEOADS72MAPS	GEOADS72LAMS	72" x 44" x 23"	223	2,834	2,975	2,409

Double-Faced 44" Wide Inline Adder  	<i>2 Adjustable Shelves and 1 Base Shelf per Side</i>							
	GEOADIA36OAKS	GEOADIA36MAPS	GEOADIA36LAMS	36" x 44" x 23"	142	\$1,962	\$2,061	\$1,667
	<i>2 Adjustable Shelves and 1 Base Shelf per Side</i>							
	GEOADIA42OAKS	GEOADIA42MAPS	GEOADIA42LAMS	42" x 44" x 23"	166	1,973	2,071	1,677
	GEOADIA48OAKS	GEOADIA48MAPS	GEOADIA48LAMS	48" x 44" x 23"	190	2,125	2,231	1,806
	<i>4 Adjustable Shelves and 1 Base Shelf per Side</i>							
	GEOADIA60OAKS	GEOADIA60MAPS	GEOADIA60LAMS	60-1/2" x 44" x 23"	210	2,572	2,701	2,187
	GEOADIA72OAKS	GEOADIA72MAPS	GEOADIA72LAMS	72" x 44" x 23"	223	2,834	2,975	2,409

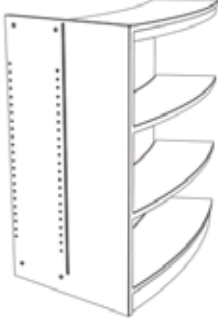
Please specify Wood Finish (Table 1) or Laminate (Table 4). Details can be found on page GEN 4 and GEN 5.

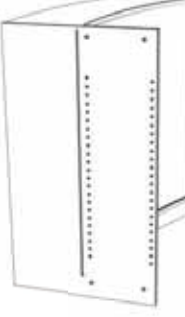
Note: Shelving Finishing Panels are sold separately on page GEO 34. Shelving Back Panels are sold separately on pages GEO 37-GEO 46.

Oak Catalog No.	Maple Catalog No.	Laminate Catalog No.	H x W x D	Wt. (lbs.)	Oak Price	Maple Price	Laminate Price	
<i>2 Adjustable Shelves and 1 Base Shelf</i>								Transitional Adders, 44" Wide Type 1 Single- to Single-Faced 
GEOATSS136OAKS	GEOATSS136MAPS	GEOATSS136LAMS	36" x 44" x 23"	95	\$1,108	\$1,163	\$955	
<i>2 Adjustable Shelves and 1 Base Shelf</i>								
GEOATSS142OAKS	GEOATSS142MAPS	GEOATSS142LAMS	42" x 44" x 23"	108	1,118	1,173	964	
GEOATSS148OAKS	GEOATSS148MAPS	GEOATSS148LAMS	48" x 44" x 23"	121	1,216	1,277	1,048	
<i>4 Adjustable Shelves and 1 Base Shelf</i>								
GEOATSS160OAKS	GEOATSS160MAPS	GEOATSS160LAMS	60-1/2" x 44" x 23"	131	1,507	1,582	1,300	
GEOATSS172OAKS	GEOATSS172MAPS	GEOATSS172LAMS	72" x 44" x 23"	139	1,704	1,789	1,470	
<i>2 Adjustable Shelves and 1 Base Shelf</i>								Transitional Adders, 44" Wide Type 2 Single- to Single-Faced 
GEOATSS236OAKS	GEOATSS236MAPS	GEOATSS236LAMS	36" x 44" x 23"	95	\$1,108	\$1,163	\$955	
<i>2 Adjustable Shelves and 1 Base Shelf</i>								
GEOATSS242OAKS	GEOATSS242MAPS	GEOATSS242LAMS	42" x 44" x 23"	108	1,118	1,173	964	
GEOATSS248OAKS	GEOATSS248MAPS	GEOATSS248LAMS	48" x 44" x 23"	121	1,216	1,277	1,048	
<i>4 Adjustable Shelves and 1 Base Shelf</i>								
GEOATSS260OAKS	GEOATSS260MAPS	GEOATSS260LAMS	60-1/2" x 44" x 23"	131	1,507	1,582	1,300	
GEOATSS272OAKS	GEOATSS272MAPS	GEOATSS272LAMS	72" x 44" x 23"	139	1,704	1,789	1,470	
<i>2 Adjustable Shelves and 1 Base Shelf</i>								Transitional Adders, 44" Wide Type 3 Single- to Single-Faced 
GEOATSS336OAKS	GEOATSS336MAPS	GEOATSS336LAMS	36" x 44" x 23"	95	\$1,108	\$1,163	\$955	
<i>2 Adjustable Shelves and 1 Base Shelf</i>								
GEOATSS342OAKS	GEOATSS342MAPS	GEOATSS342LAMS	42" x 44" x 23"	108	1,118	1,173	964	
GEOATSS348OAKS	GEOATSS348MAPS	GEOATSS348LAMS	48" x 44" x 23"	121	1,216	1,277	1,048	
<i>4 Adjustable Shelves and 1 Base Shelf</i>								
GEOATSS360OAKS	GEOATSS360MAPS	GEOATSS360LAMS	60-1/2" x 44" x 23"	131	1,507	1,582	1,300	
GEOATSS372OAKS	GEOATSS372MAPS	GEOATSS372LAMS	72" x 44" x 23"	139	1,704	1,789	1,470	

Please specify Wood Finish (Table 1) or Laminate (Table 4). Details can be found on page GEN 4 and GEN 5.

Note: Shelving Finishing Panels are sold separately on page GEO 34. Shelving Back Panels are sold separately on pages GEO 37-GEO 46.

	Oak Catalog No.	Maple Catalog No.	Laminate Catalog No.	H x W x D	Wt. (lbs.)	Oak Price	Maple Price	Laminate Price
	<i>2 Adjustable Shelves and 1 Base Shelf</i>							
	GEOATSS436OAKS	GEOATSS436MAPS	GEOATSS436LAMs	36" x 44" x 23"	95	\$1,108	\$1,163	\$955
	<i>2 Adjustable Shelves and 1 Base Shelf</i>							
	GEOATSS442OAKS	GEOATSS442MAPS	GEOATSS442LAMs	42" x 44" x 23"	108	1,118	1,173	964
	GEOATSS448OAKS	GEOATSS448MAPS	GEOATSS448LAMs	48" x 44" x 23"	121	1,216	1,277	1,048
	<i>4 Adjustable Shelves and 1 Base Shelf</i>							
	GEOATSS460OAKS	GEOATSS460MAPS	GEOATSS460LAMs	60-1/2" x 44" x 23"	131	1,507	1,582	1,300
	GEOATSS472OAKS	GEOATSS472MAPS	GEOATSS472LAMs	72" x 44" x 23"	139	1,704	1,789	1,470

	<i>2 Adjustable Shelves and 1 Base Shelf</i>							
	GEOATSS536OAKS	GEOATSS536MAPS	GEOATSS536LAMs	36" x 37" x 23"	83	\$1,108	\$1,163	\$955
	<i>2 Adjustable Shelves and 1 Base Shelf</i>							
	GEOATSS542OAKS	GEOATSS542MAPS	GEOATSS542LAMs	42" x 37" x 23"	96	1,118	1,173	964
	GEOATSS548OAKS	GEOATSS548MAPS	GEOATSS548LAMs	48" x 37" x 23"	109	1,216	1,277	1,048
	<i>4 Adjustable Shelves and 1 Base Shelf</i>							
	GEOATSS560OAKS	GEOATSS560MAPS	GEOATSS560LAMs	60-1/2" x 37" x 23"	119	1,507	1,582	1,300
	GEOATSS572OAKS	GEOATSS572MAPS	GEOATSS572LAMs	72" x 37" x 23"	127	1,704	1,789	1,470

	<i>2 Adjustable Shelves and 1 Base Shelf</i>							
	GEOATSS636OAKS	GEOATSS636MAPS	GEOATSS636LAMs	36" x 37" x 23"	83	\$1,108	\$1,163	\$955
	<i>2 Adjustable Shelves and 1 Base Shelf</i>							
	GEOATSS642OAKS	GEOATSS642MAPS	GEOATSS642LAMs	42" x 37" x 23"	96	1,118	1,173	964
	GEOATSS648OAKS	GEOATSS648MAPS	GEOATSS648LAMs	48" x 37" x 23"	109	1,216	1,277	1,048
	<i>4 Adjustable Shelves and 1 Base Shelf</i>							
	GEOATSS660OAKS	GEOATSS660MAPS	GEOATSS660LAMs	60-1/2" x 37" x 23"	119	1,507	1,582	1,300
	GEOATSS672OAKS	GEOATSS672MAPS	GEOATSS672LAMs	72" x 37" x 23"	127	1,704	1,789	1,470

Please specify Wood Finish (Table 1) or Laminate (Table 4). Details can be found on page GEN 4 and GEN 5.

Note: Shelving Finishing Panels are sold separately on page GEO 34. Shelving Back Panels are sold separately on pages GEO 37-GEO 46.

Oak Catalog No.	Maple Catalog No.	Laminate Catalog No.	H x W x D	Wt. (lbs.)	Oak Price	Maple Price	Laminate Price
-----------------	-------------------	----------------------	-----------	------------	-----------	-------------	----------------

2 Adjustable Shelves and 1 Base Shelf per Side

GEOATSD136OAKS	GEOATSD136MAPS	GEOATSD136LAMS	36" x 44" x 23"	142	\$1,962	\$2,061	\$1,667
----------------	----------------	----------------	-----------------	-----	---------	---------	---------

2 Adjustable Shelves and 1 Base Shelf per Side

GEOATSD142OAKS	GEOATSD142MAPS	GEOATSD142LAMS	42" x 44" x 23"	166	1,973	2,071	1,677
GEOATSD148OAKS	GEOATSD148MAPS	GEOATSD148LAMS	48" x 44" x 23"	190	2,125	2,231	1,806

4 Adjustable Shelves and 1 Base Shelf per Side

GEOATSD160OAKS	GEOATSD160MAPS	GEOATSD160LAMS	60-1/2" x 44" x 23"	210	2,572	2,701	2,187
GEOATSD172OAKS	GEOATSD172MAPS	GEOATSD172LAMS	72" x 44" x 23"	223	2,834	2,975	2,409

Transitional Adders, Type 1
Single- to Double-Faced



2 Adjustable Shelves and 1 Base Shelf per Side

GEOATSD236OAKS	GEOATSD236MAPS	GEOATSD236LAMS	36" x 44" x 23"	142	\$1,962	\$2,061	\$1,667
----------------	----------------	----------------	-----------------	-----	---------	---------	---------

2 Adjustable Shelves and 1 Base Shelf per Side

GEOATSD242OAKS	GEOATSD242MAPS	GEOATSD242LAMS	42" x 44" x 23"	166	1,973	2,071	1,677
GEOATSD248OAKS	GEOATSD248MAPS	GEOATSD248LAMS	48" x 44" x 23"	190	2,125	2,231	1,806

4 Adjustable Shelves and 1 Base Shelf per Side

GEOATSD260OAKS	GEOATSD260MAPS	GEOATSD260LAMS	60-1/2" x 44" x 23"	210	2,572	2,701	2,187
GEOATSD272OAKS	GEOATSD272MAPS	GEOATSD272LAMS	72" x 44" x 23"	223	2,834	2,975	2,409

Transitional Adders, Type 2
Single- to Double-Faced

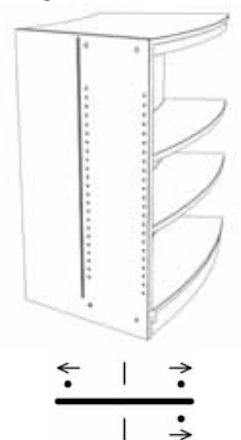

2 Adjustable Shelves and 1 Base Shelf

GEOATDS136OAKS	GEOATDS136MAPS	GEOATDS136LAMS	36" x 37" x 23"	83	\$1,108	\$1,163	\$ 955
----------------	----------------	----------------	-----------------	----	---------	---------	--------

2 Adjustable Shelves and 1 Base Shelf

GEOATDS142OAKS	GEOATDS142MAPS	GEOATDS142LAMS	42" x 37" x 23"	96	1,118	1,173	964
GEOATDS148OAKS	GEOATDS148MAPS	GEOATDS148LAMS	48" x 37" x 23"	109	1,216	1,277	1,048

4 Adjustable Shelves and 1 Base Shelf



GEOATDS160OAKS	GEOATDS160MAPS	GEOATDS160LAMS	60-1/2" x 37" x 23"	119	1,507	1,582	1,300
GEOATDS172OAKS	GEOATDS172MAPS	GEOATDS172LAMS	72" x 37" x 23"	127	1,704	1,789	1,470

Transitional Adders,
37" Wide Type 1
Double- to Single-Faced



Please specify Wood Finish (Table 1) or Laminate (Table 4). Details can be found on page GEN 4 and GEN 5.

Note: Shelving Finishing Panels are sold separately on page GEO 34. Shelving Back Panels are sold separately on pages GEO 37-GEO 46.

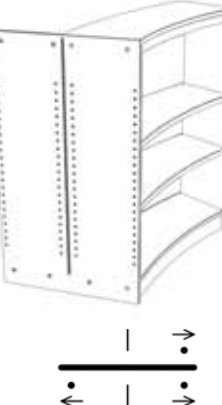
	Oak Catalog No.	Maple Catalog No.	Laminate Catalog No.	H x W x D	Wt. (lbs.)	Oak Price	Maple Price	Laminate Price	
Transitional Adders, 44" Wide Type 2 Double- to Single-Faced 	<i>2 Adjustable Shelves and 1 Base Shelf</i>								
	GEOATDS236OAKS	GEOATDS236MAPS	GEOATDS236LAMs	36" x 44" x 23"	95	\$1,108	\$1,163	\$ 955	
	<i>2 Adjustable Shelves and 1 Base Shelf</i>								
	GEOATDS242OAKS	GEOATDS242MAPS	GEOATDS242LAMs	42" x 44" x 23"	108	1,118	1,173	964	
	GEOATDS248OAKS	GEOATDS248MAPS	GEOATDS248LAMs	48" x 44" x 23"	121	1,216	1,277	1,048	
	<i>4 Adjustable Shelves and 1 Base Shelf</i>								
	GEOATDS260OAKS	GEOATDS260MAPS	GEOATDS260LAMs	60-1/2" x 44" x 23"	131	1,507	1,582	1,300	
	GEOATDS272OAKS	GEOATDS272MAPS	GEOATDS272LAMs	72" x 44" x 23"	139	1,704	1,789	1,470	
	Transitional Adders, 44" Wide Type 3 Double- to Single-Faced 	<i>2 Adjustable Shelves and 1 Base Shelf</i>							
		GEOATDS336OAKS	GEOATDS336MAPS	GEOATDS336LAMs	36" x 44" x 23"	95	\$1,108	\$1,163	\$ 955
<i>2 Adjustable Shelves and 1 Base Shelf</i>									
GEOATDS342OAKS		GEOATDS342MAPS	GEOATDS342LAMs	42" x 44" x 23"	108	1,118	1,173	964	
GEOATDS348OAKS		GEOATDS348MAPS	GEOATDS348LAMs	48" x 44" x 23"	121	1,216	1,277	1,048	
<i>4 Adjustable Shelves and 1 Base Shelf</i>									
GEOATDS360OAKS		GEOATDS360MAPS	GEOATDS360LAMs	60-1/2" x 44" x 23"	131	1,507	1,582	1,300	
GEOATDS372OAKS		GEOATDS372MAPS	GEOATDS372LAMs	72" x 44" x 23"	139	1,704	1,789	1,470	
Transitional Adders, 37" Wide Type 4 Double- to Single-Faced 		<i>2 Adjustable Shelves and 1 Base Shelf</i>							
		GEOATDS436OAKS	GEOATDS436MAPS	GEOATDS436LAMs	36" x 37" x 23"	83	\$1,108	\$1,163	\$ 955
	<i>2 Adjustable Shelves and 1 Base Shelf</i>								
	GEOATDS442OAKS	GEOATDS442MAPS	GEOATDS442LAMs	42" x 37" x 23"	96	1,118	1,173	964	
	GEOATDS448OAKS	GEOATDS448MAPS	GEOATDS448LAMs	48" x 37" x 23"	109	1,216	1,277	1,048	
	<i>4 Adjustable Shelves and 1 Base Shelf</i>								
	GEOATDS460OAKS	GEOATDS460MAPS	GEOATDS460LAMs	60-1/2" x 37" x 23"	119	1,507	1,582	1,300	
	GEOATDS472OAKS	GEOATDS472MAPS	GEOATDS472LAMs	72" x 37" x 23"	127	1,704	1,789	1,470	

Please specify Wood Finish (Table 1) or Laminate (Table 4). Details can be found on page GEN 4 and GEN 5.

Note: Shelving Finishing Panels are sold separately on page GEO 34. Shelving Back Panels are sold separately on pages GEO 37-GEO 46.

Single-Faced 3-Way Towers Only (Adders sold separately)

- ▽ = Tower/Transitional Tower
- | = Back Panel Location
- = Shelving Side
- = Open Shelving Direction

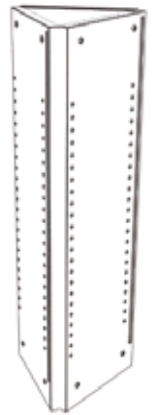

Oak Catalog No.	Maple Catalog No.	Laminate Catalog No.	H x W x D	Wt. (lbs.)	Oak Price	Maple Price	Laminate Price
-----------------	-------------------	----------------------	-----------	------------	-----------	-------------	----------------

Single-Faced 3-Way Towers, Type 1

GEO3WST136OAKS	GEO3WST136MAPS	GEO3WST136LAMS	36" x 12" x 12"	29	\$604	\$635	\$451
GEO3WST142OAKS	GEO3WST142MAPS	GEO3WST142LAMS	42" x 12" x 12"	35	615	646	462
GEO3WST148OAKS	GEO3WST148MAPS	GEO3WST148LAMS	48" x 12" x 12"	41	626	657	473
GEO3WST160OAKS	GEO3WST160MAPS	GEO3WST160LAMS	60-1/2" x 12" x 12"	48	648	679	495
GEO3WST172OAKS	GEO3WST172MAPS	GEO3WST172LAMS	72" x 12" x 12"	60	670	701	517

Single-Faced Type 1

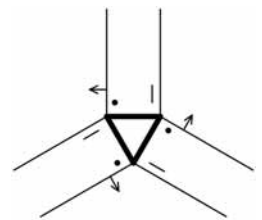

Single-Faced 3-Way Towers, Type 2

GEO3WST236OAKS	GEO3WST236MAPS	GEO3WST236LAMS	36" x 12" x 12"	29	\$604	\$635	\$451
GEO3WST242OAKS	GEO3WST242MAPS	GEO3WST242LAMS	42" x 12" x 12"	35	615	646	462
GEO3WST248OAKS	GEO3WST248MAPS	GEO3WST248LAMS	48" x 12" x 12"	41	626	657	473
GEO3WST260OAKS	GEO3WST260MAPS	GEO3WST260LAMS	60-1/2" x 12" x 12"	48	648	679	495
GEO3WST272OAKS	GEO3WST272MAPS	GEO3WST272LAMS	72" x 12" x 12"	60	670	701	517

Single-Faced Type 2

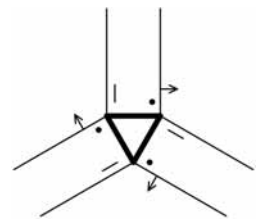

Single-Faced 3-Way Towers, Type 3

GEO3WST336OAKS	GEO3WST336MAPS	GEO3WST336LAMS	36" x 12" x 12"	29	\$604	\$635	\$451
GEO3WST342OAKS	GEO3WST342MAPS	GEO3WST342LAMS	42" x 12" x 12"	35	615	646	462
GEO3WST348OAKS	GEO3WST348MAPS	GEO3WST348LAMS	48" x 12" x 12"	41	626	657	473
GEO3WST360OAKS	GEO3WST360MAPS	GEO3WST360LAMS	60-1/2" x 12" x 12"	48	648	679	495
GEO3WST372OAKS	GEO3WST372MAPS	GEO3WST372LAMS	72" x 12" x 12"	60	670	701	517

Single-Faced Type 3

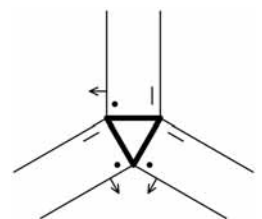

Single-Faced 3-Way Towers, Type 4

GEO3WST436OAKS	GEO3WST436MAPS	GEO3WST436LAMS	36" x 12" x 12"	29	\$604	\$635	\$451
GEO3WST442OAKS	GEO3WST442MAPS	GEO3WST442LAMS	42" x 12" x 12"	35	615	646	462
GEO3WST448OAKS	GEO3WST448MAPS	GEO3WST448LAMS	48" x 12" x 12"	41	626	657	473
GEO3WST460OAKS	GEO3WST460MAPS	GEO3WST460LAMS	60-1/2" x 12" x 12"	48	648	679	495
GEO3WST472OAKS	GEO3WST472MAPS	GEO3WST472LAMS	72" x 12" x 12"	60	670	701	517

Single-Faced Type 4

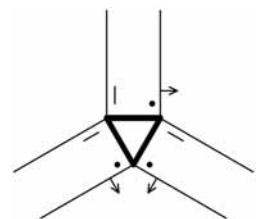

Please specify Wood Finish (Table 1) or Laminate (Table 4). Details can be found on page GEN 4 and GEN 5.



Double-Faced 3-Way Towers Only (Adders sold separately)

- ▽ = Tower/Transitional Tower
- | = Back Panel Location
- = Shelving Side
- = Open Shelving Direction

Double-Faced

Double-Faced 3-Way Towers

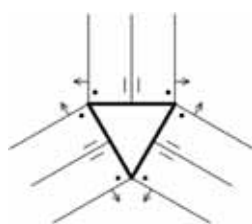

Oak Catalog No.	Maple Catalog No.	Laminate Catalog No.	H x W x D	Wt. (lbs.)	Oak Price	Maple Price	Laminate Price
GEO3WDT36OAKS	GEO3WDT36MAPS	GEO3WDT36LAMS	36" x 23" x 23"	56	\$ 945	\$ 990	\$708
GEO3WDT42OAKS	GEO3WDT42MAPS	GEO3WDT42LAMS	42" x 23" x 23"	68	956	1,001	719
GEO3WDT48OAKS	GEO3WDT48MAPS	GEO3WDT48LAMS	48" x 23" x 23"	70	967	1,012	730
GEO3WDT60OAKS	GEO3WDT60MAPS	GEO3WDT60LAMS	60-1/2" x 23" x 23"	74	989	1,034	752
GEO3WDT72OAKS	GEO3WDT72MAPS	GEO3WDT72LAMS	72" x 23" x 23"	96	1,011	1,056	774

Double- to Single-Faced Type 1

Double-Faced 3-Way Towers, Type 1

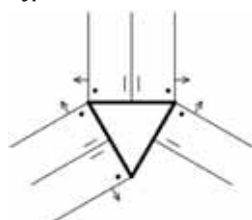

GEO3WDT136OAKS	GEO3WDT136MAPS	GEO3WDT136LAMS	36" x 23" x 23"	56	\$945	\$990	\$708
GEO3WDT142OAKS	GEO3WDT142MAPS	GEO3WDT142LAMS	42" x 23" x 23"	68	956	1,001	719
GEO3WDT148OAKS	GEO3WDT148MAPS	GEO3WDT148LAMS	48" x 23" x 23"	70	967	1,012	730
GEO3WDT160OAKS	GEO3WDT160MAPS	GEO3WDT160LAMS	60-1/2" x 23" x 23"	74	989	1,034	752
GEO3WDT172OAKS	GEO3WDT172MAPS	GEO3WDT172LAMS	72" x 23" x 23"	96	1,011	1,056	774

Double- to Single-Faced Type 2

Double-Faced 3-Way Towers, Type 2

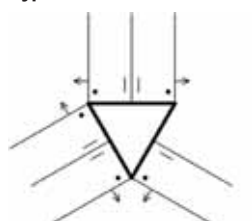

GEO3WDT236OAKS	GEO3WDT236MAPS	GEO3WDT236LAMS	36" x 23" x 23"	56	\$945	\$990	\$708
GEO3WDT242OAKS	GEO3WDT242MAPS	GEO3WDT242LAMS	42" x 23" x 23"	68	956	1,001	719
GEO3WDT248OAKS	GEO3WDT248MAPS	GEO3WDT248LAMS	48" x 23" x 23"	70	967	1,012	730
GEO3WDT260OAKS	GEO3WDT260MAPS	GEO3WDT260LAMS	60-1/2" x 23" x 23"	74	989	1,034	752
GEO3WDT272OAKS	GEO3WDT272MAPS	GEO3WDT272LAMS	72" x 23" x 23"	96	1,011	1,056	774

Please specify Wood Finish (Table 1) or Laminate (Table 4). Details can be found on page GEN 4 and GEN 5.

Trapezoid 3-Way Towers Only (Adders sold separately)

- ▽ = Tower/Transitional Tower
- | = Back Panel Location
- = Shelving Side
- = Open Shelving Direction

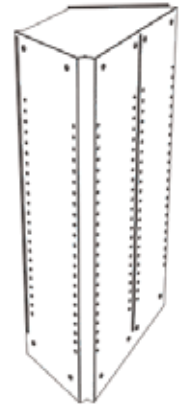

Oak Catalog No.	Maple Catalog No.	Laminate Catalog No.	H x W x D	Wt. (lbs.)	Oak Price	Maple Price	Laminate Price
3-Way Trapezoid Towers, Type 1							
GEO3WTT136OAKS	GEO3WTT136MAPS	GEO3WTT136LAMS	36" x 23" x 12"	50	\$ 911	\$ 956	\$682
GEO3WTT142OAKS	GEO3WTT142MAPS	GEO3WTT142LAMS	42" x 23" x 12"	51	931	976	702
GEO3WTT148OAKS	GEO3WTT148MAPS	GEO3WTT148LAMS	48" x 23" x 12"	60	951	996	722
GEO3WTT160OAKS	GEO3WTT160MAPS	GEO3WTT160LAMS	60-1/2" x 23" x 12"	64	991	1,036	762
GEO3WTT172OAKS	GEO3WTT172MAPS	GEO3WTT172LAMS	72" x 23" x 12"	86	1,031	1,076	802
3-Way Trapezoid Towers, Whiteboard Type 1							
GEO3WTTW136OAKS	GEO3WTTW136MAPS	GEO3WTTW136LAMS	36" x 23" x 12"	52	\$ 957	\$1,002	\$728
GEO3WTTW142OAKS	GEO3WTTW142MAPS	GEO3WTTW142LAMS	42" x 23" x 12"	53	977	1,022	748
GEO3WTTW148OAKS	GEO3WTTW148MAPS	GEO3WTTW148LAMS	48" x 23" x 12"	62	997	1,042	768
GEO3WTTW160OAKS	GEO3WTTW160MAPS	GEO3WTTW160LAMS	60-1/2" x 23" x 12"	66	1,037	1,082	808
GEO3WTTW172OAKS	GEO3WTTW172MAPS	GEO3WTTW172LAMS	72" x 23" x 12"	88	1,077	1,122	848
3-Way Trapezoid Towers, Magnetic Whiteboard Type 1							
GEO3WTTM136OAKS	GEO3WTTM136MAPS	GEO3WTTM136LAMS	36" x 23" x 12"	52	\$ 987	\$1,032	\$758
GEO3WTTM142OAKS	GEO3WTTM142MAPS	GEO3WTTM142LAMS	42" x 23" x 12"	53	1,007	1,052	778
GEO3WTTM148OAKS	GEO3WTTM148MAPS	GEO3WTTM148LAMS	48" x 23" x 12"	62	1,027	1,072	798
GEO3WTTM160OAKS	GEO3WTTM160MAPS	GEO3WTTM160LAMS	60-1/2" x 23" x 12"	66	1,067	1,112	838
GEO3WTTM172OAKS	GEO3WTTM172MAPS	GEO3WTTM172LAMS	72" x 23" x 12"	88	1,107	1,152	878
3-Way Trapezoid Towers, Tackboard Type 1							
GEO3WTTT136OAKS	GEO3WTTT136MAPS	GEO3WTTT136LAMS	36" x 23" x 12"	54	\$ 963	\$1,008	\$734
GEO3WTTT142OAKS	GEO3WTTT142MAPS	GEO3WTTT142LAMS	42" x 23" x 12"	55	983	1,028	754
GEO3WTTT148OAKS	GEO3WTTT148MAPS	GEO3WTTT148LAMS	48" x 23" x 12"	64	1,003	1,048	774
GEO3WTTT160OAKS	GEO3WTTT160MAPS	GEO3WTTT160LAMS	60-1/2" x 23" x 12"	68	1,043	1,088	814
GEO3WTTT172OAKS	GEO3WTTT172MAPS	GEO3WTTT172LAMS	72" x 23" x 12"	90	1,083	1,128	854
3-Way Trapezoid Towers, Upholstered Type 1							
GEO3WTTU136OAKS	GEO3WTTU136MAPS	GEO3WTTU136LAMS	36" x 23" x 12"	56	\$1,048	\$1,093	\$819
GEO3WTTU142OAKS	GEO3WTTU142MAPS	GEO3WTTU142LAMS	42" x 23" x 12"	57	1,068	1,113	839
GEO3WTTU148OAKS	GEO3WTTU148MAPS	GEO3WTTU148LAMS	48" x 23" x 12"	66	1,088	1,133	859
GEO3WTTU160OAKS	GEO3WTTU160MAPS	GEO3WTTU160LAMS	60-1/2" x 23" x 12"	70	1,128	1,173	899
GEO3WTTU172OAKS	GEO3WTTU172MAPS	GEO3WTTU172LAMS	72" x 23" x 12"	92	1,168	1,213	939

Trapezoid Type 1

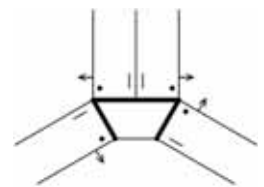

Please specify Wood Finish (Table 1) or Laminate (Table 4). Details can be found on page GEN 4 and GEN 5.

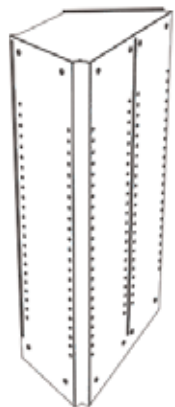

Trapezoid 3-Way Towers Only (Adders sold separately)

- ▽ = Tower/Transitional Tower
- | = Back Panel Location
- = Shelving Side
- = Open Shelving Direction

Trapezoid Type 2

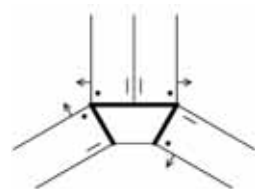

Oak Catalog No.	Maple Catalog No.	Laminate Catalog No.	H x W x D	Wt. (lbs.)	Oak Price	Maple Price	Laminate Price
3-Way Trapezoid Towers, Type 2							
GEO3WTT236OAKS	GEO3WTT236MAPS	GEO3WTT236LAMS	36" x 23" x 12"	50	\$ 911	\$ 956	\$682
GEO3WTT242OAKS	GEO3WTT242MAPS	GEO3WTT242LAMS	42" x 23" x 12"	51	931	976	702
GEO3WTT248OAKS	GEO3WTT248MAPS	GEO3WTT248LAMS	48" x 23" x 12"	60	951	996	722
GEO3WTT260OAKS	GEO3WTT260MAPS	GEO3WTT260LAMS	60-1/2" x 23" x 12"	64	991	1,036	762
GEO3WTT272OAKS	GEO3WTT272MAPS	GEO3WTT272LAMS	72" x 23" x 12"	86	1,031	1,076	802
3-Way Trapezoid Towers, Whiteboard Type 2							
GEO3WTTW236OAKS	GEO3WTTW236MAPS	GEO3WTTW236LAMS	36" x 23" x 12"	52	\$ 957	\$1,002	\$728
GEO3WTTW242OAKS	GEO3WTTW242MAPS	GEO3WTTW242LAMS	42" x 23" x 12"	53	977	1,022	748
GEO3WTTW248OAKS	GEO3WTTW248MAPS	GEO3WTTW248LAMS	48" x 23" x 12"	62	997	1,042	768
GEO3WTTW260OAKS	GEO3WTTW260MAPS	GEO3WTTW260LAMS	60-1/2" x 23" x 12"	66	1,037	1,082	808
GEO3WTTW272OAKS	GEO3WTTW272MAPS	GEO3WTTW272LAMS	72" x 23" x 12"	88	1,077	1,122	848
3-Way Trapezoid Towers, Magnetic Whiteboard Type 2							
GEO3WTTM236OAKS	GEO3WTTM236MAPS	GEO3WTTM236LAMS	36" x 23" x 12"	52	\$ 987	\$1,032	\$758
GEO3WTTM242OAKS	GEO3WTTM242MAPS	GEO3WTTM242LAMS	42" x 23" x 12"	53	1,007	1,052	778
GEO3WTTM248OAKS	GEO3WTTM248MAPS	GEO3WTTM248LAMS	48" x 23" x 12"	62	1,027	1,072	798
GEO3WTTM260OAKS	GEO3WTTM260MAPS	GEO3WTTM260LAMS	60-1/2" x 23" x 12"	66	1,067	1,112	838
GEO3WTTM272OAKS	GEO3WTTM272MAPS	GEO3WTTM272LAMS	72" x 23" x 12"	88	1,107	1,152	878
3-Way Trapezoid Towers, Tackboard Type 2							
GEO3WTTT236OAKS	GEO3WTTT236MAPS	GEO3WTTT236LAMS	36" x 23" x 12"	54	\$ 963	\$1,008	\$734
GEO3WTTT242OAKS	GEO3WTTT242MAPS	GEO3WTTT242LAMS	42" x 23" x 12"	55	983	1,028	754
GEO3WTTT248OAKS	GEO3WTTT248MAPS	GEO3WTTT248LAMS	48" x 23" x 12"	64	1,003	1,048	774
GEO3WTTT260OAKS	GEO3WTTT260MAPS	GEO3WTTT260LAMS	60-1/2" x 23" x 12"	68	1,043	1,088	814
GEO3WTTT272OAKS	GEO3WTTT272MAPS	GEO3WTTT272LAMS	72" x 23" x 12"	90	1,083	1,128	854
3-Way Trapezoid Towers, Upholstered Type 2							
GEO3WTTU236OAKS	GEO3WTTU236MAPS	GEO3WTTU236LAMS	36" x 23" x 12"	56	\$1,048	\$1,093	\$819
GEO3WTTU242OAKS	GEO3WTTU242MAPS	GEO3WTTU242LAMS	42" x 23" x 12"	57	1,068	1,113	839
GEO3WTTU248OAKS	GEO3WTTU248MAPS	GEO3WTTU248LAMS	48" x 23" x 12"	66	1,088	1,133	859
GEO3WTTU260OAKS	GEO3WTTU260MAPS	GEO3WTTU260LAMS	60-1/2" x 23" x 12"	70	1,128	1,173	899
GEO3WTTU272OAKS	GEO3WTTU272MAPS	GEO3WTTU272LAMS	72" x 23" x 12"	92	1,168	1,213	939

Please specify Wood Finish (Table 1) or Laminate (Table 4). Details can be found on page GEN 4 and GEN 5.

Trapezoid 3-Way Towers Only (Adders sold separately)

- ▽ = Tower/Transitional Tower
- | = Back Panel Location
- = Shelving Side
- = Open Shelving Direction

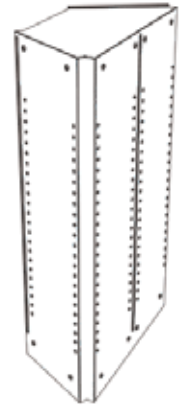

Oak Catalog No.	Maple Catalog No.	Laminate Catalog No.	H x W x D	Wt. (lbs.)	Oak Price	Maple Price	Laminate Price
3-Way Trapezoid Towers, Type 3							
GEO3WTT336OAKS	GEO3WTT336MAPS	GEO3WTT336LAMS	36" x 23" x 12"	50	\$ 911	\$ 956	\$682
GEO3WTT342OAKS	GEO3WTT342MAPS	GEO3WTT342LAMS	42" x 23" x 12"	51	931	976	702
GEO3WTT348OAKS	GEO3WTT348MAPS	GEO3WTT348LAMS	48" x 23" x 12"	60	951	996	722
GEO3WTT360OAKS	GEO3WTT360MAPS	GEO3WTT360LAMS	60-1/2" x 23" x 12"	64	991	1,036	762
GEO3WTT372OAKS	GEO3WTT372MAPS	GEO3WTT372LAMS	72" x 23" x 12"	86	1,031	1,076	802
3-Way Trapezoid Towers, Whiteboard Type 3							
GEO3WTTW336OAKS	GEO3WTTW336MAPS	GEO3WTTW336LAMS	36" x 23" x 12"	52	\$ 957	\$1,002	\$728
GEO3WTTW342OAKS	GEO3WTTW342MAPS	GEO3WTTW342LAMS	42" x 23" x 12"	53	977	1,022	748
GEO3WTTW348OAKS	GEO3WTTW348MAPS	GEO3WTTW348LAMS	48" x 23" x 12"	62	997	1,042	768
GEO3WTTW360OAKS	GEO3WTTW360MAPS	GEO3WTTW360LAMS	60-1/2" x 23" x 12"	66	1,037	1,082	808
GEO3WTTW372OAKS	GEO3WTTW372MAPS	GEO3WTTW372LAMS	72" x 23" x 12"	88	1,077	1,122	848
3-Way Trapezoid Towers, Magnetic Whiteboard Type 3							
GEO3WTTM336OAKS	GEO3WTTM336MAPS	GEO3WTTM336LAMS	36" x 23" x 12"	52	\$ 987	\$1,032	\$758
GEO3WTTM342OAKS	GEO3WTTM342MAPS	GEO3WTTM342LAMS	42" x 23" x 12"	53	1,007	1,052	778
GEO3WTTM348OAKS	GEO3WTTM348MAPS	GEO3WTTM348LAMS	48" x 23" x 12"	62	1,027	1,072	798
GEO3WTTM360OAKS	GEO3WTTM360MAPS	GEO3WTTM360LAMS	60-1/2" x 23" x 12"	66	1,067	1,112	838
GEO3WTTM372OAKS	GEO3WTTM372MAPS	GEO3WTTM372LAMS	72" x 23" x 12"	88	1,107	1,152	878
3-Way Trapezoid Towers, Tackboard Type 3							
GEO3WTTT336OAKS	GEO3WTTT336MAPS	GEO3WTTT336LAMS	36" x 23" x 12"	54	\$ 963	\$1,008	\$734
GEO3WTTT342OAKS	GEO3WTTT342MAPS	GEO3WTTT342LAMS	42" x 23" x 12"	55	983	1,028	754
GEO3WTTT348OAKS	GEO3WTTT348MAPS	GEO3WTTT348LAMS	48" x 23" x 12"	64	1,003	1,048	774
GEO3WTTT360OAKS	GEO3WTTT360MAPS	GEO3WTTT360LAMS	60-1/2" x 23" x 12"	68	1,043	1,088	814
GEO3WTTT372OAKS	GEO3WTTT372MAPS	GEO3WTTT372LAMS	72" x 23" x 12"	90	1,083	1,128	854
3-Way Trapezoid Towers, Upholstered Type 3							
GEO3WTTU336OAKS	GEO3WTTU336MAPS	GEO3WTTU336LAMS	36" x 23" x 12"	56	\$1,048	\$1,093	\$819
GEO3WTTU342OAKS	GEO3WTTU342MAPS	GEO3WTTU342LAMS	42" x 23" x 12"	57	1,068	1,113	839
GEO3WTTU348OAKS	GEO3WTTU348MAPS	GEO3WTTU348LAMS	48" x 23" x 12"	66	1,088	1,133	859
GEO3WTTU360OAKS	GEO3WTTU360MAPS	GEO3WTTU360LAMS	60-1/2" x 23" x 12"	70	1,128	1,173	899
GEO3WTTU372OAKS	GEO3WTTU372MAPS	GEO3WTTU372LAMS	72" x 23" x 12"	92	1,168	1,213	939

Trapezoid Type 3

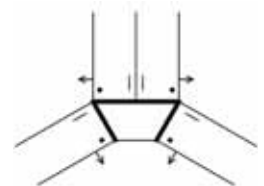

Please specify Wood Finish (Table 1) or Laminate (Table 4). Details can be found on page GEN 4 and GEN 5.



Trapezoid 3-Way Towers Only (Adders sold separately)

- ▽ = Tower/Transitional Tower
- | = Back Panel Location
- = Shelving Side
- = Open Shelving Direction

Trapezoid Type 4

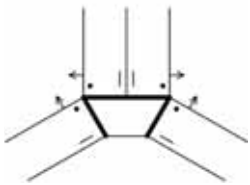

Oak Catalog No.	Maple Catalog No.	Laminate Catalog No.	H x W x D	Wt. (lbs.)	Oak Price	Maple Price	Laminate Price
Trapezoid Type 4							
3-Way Trapezoid Towers, Type 4							
GEO3WTT436OAKS	GEO3WTT436MAPS	GEO3WTT436LAMS	36" x 23" x 12"	50	\$ 911	\$ 956	\$682
GEO3WTT442OAKS	GEO3WTT442MAPS	GEO3WTT442LAMS	42" x 23" x 12"	51	931	976	702
GEO3WTT448OAKS	GEO3WTT448MAPS	GEO3WTT448LAMS	48" x 23" x 12"	60	951	996	722
GEO3WTT460OAKS	GEO3WTT460MAPS	GEO3WTT460LAMS	60-1/2" x 23" x 12"	64	991	1,036	762
GEO3WTT472OAKS	GEO3WTT472MAPS	GEO3WTT472LAMS	72" x 23" x 12"	86	1,031	1,076	802
3-Way Trapezoid Towers, Whiteboard Type 4							
GEO3WTTW436OAKS	GEO3WTTW436MAPS	GEO3WTTW436LAMS	36" x 23" x 12"	52	\$ 957	\$1,002	\$728
GEO3WTTW442OAKS	GEO3WTTW442MAPS	GEO3WTTW442LAMS	42" x 23" x 12"	53	977	1,022	748
GEO3WTTW448OAKS	GEO3WTTW448MAPS	GEO3WTTW448LAMS	48" x 23" x 12"	62	997	1,042	768
GEO3WTTW460OAKS	GEO3WTTW460MAPS	GEO3WTTW460LAMS	60-1/2" x 23" x 12"	66	1,037	1,082	808
GEO3WTTW472OAKS	GEO3WTTW472MAPS	GEO3WTTW472LAMS	72" x 23" x 12"	88	1,077	1,122	848
3-Way Trapezoid Towers, Magnetic Whiteboard Type 4							
GEO3WTTM436OAKS	GEO3WTTM436MAPS	GEO3WTTM436LAMS	36" x 23" x 12"	52	\$ 987	\$1,032	\$758
GEO3WTTM442OAKS	GEO3WTTM442MAPS	GEO3WTTM442LAMS	42" x 23" x 12"	53	1,007	1,052	778
GEO3WTTM448OAKS	GEO3WTTM448MAPS	GEO3WTTM448LAMS	48" x 23" x 12"	62	1,027	1,072	798
GEO3WTTM460OAKS	GEO3WTTM460MAPS	GEO3WTTM460LAMS	60-1/2" x 23" x 12"	66	1,067	1,112	838
GEO3WTTM472OAKS	GEO3WTTM472MAPS	GEO3WTTM472LAMS	72" x 23" x 12"	88	1,107	1,152	878
3-Way Trapezoid Towers, Tackboard Type 4							
GEO3WTTT436OAKS	GEO3WTTT436MAPS	GEO3WTTT436LAMS	36" x 23" x 12"	54	\$ 963	\$1,008	\$734
GEO3WTTT442OAKS	GEO3WTTT442MAPS	GEO3WTTT442LAMS	42" x 23" x 12"	55	983	1,028	754
GEO3WTTT448OAKS	GEO3WTTT448MAPS	GEO3WTTT448LAMS	48" x 23" x 12"	64	1,003	1,048	774
GEO3WTTT460OAKS	GEO3WTTT460MAPS	GEO3WTTT460LAMS	60-1/2" x 23" x 12"	68	1,043	1,088	814
GEO3WTTT472OAKS	GEO3WTTT472MAPS	GEO3WTTT472LAMS	72" x 23" x 12"	90	1,083	1,128	854
3-Way Trapezoid Towers, Upholstered Type 4							
GEO3WTTU436OAKS	GEO3WTTU436MAPS	GEO3WTTU436LAMS	36" x 23" x 12"	56	\$1,048	\$1,093	\$819
GEO3WTTU442OAKS	GEO3WTTU442MAPS	GEO3WTTU442LAMS	42" x 23" x 12"	57	1,068	1,113	839
GEO3WTTU448OAKS	GEO3WTTU448MAPS	GEO3WTTU448LAMS	48" x 23" x 12"	66	1,088	1,133	859
GEO3WTTU460OAKS	GEO3WTTU460MAPS	GEO3WTTU460LAMS	60-1/2" x 23" x 12"	70	1,128	1,173	899
GEO3WTTU472OAKS	GEO3WTTU472MAPS	GEO3WTTU472LAMS	72" x 23" x 12"	92	1,168	1,213	939

Please specify Wood Finish (Table 1) or Laminate (Table 4). Details can be found on page GEN 4 and GEN 5.

Oak Catalog No.	Maple Catalog No.	Laminate Catalog No.	Height	Wt. (lbs.)	Oak Price	Maple Price	Laminate Price	
1 Top, 1 Base, and 2 Shelves								Single-Faced
GEOLSKIT36OAKS	GEOLSKIT36MAPS	GEOLSKIT36LAMS	36"	55	\$478	\$501	\$359	
GEOLSKIT42OAKS	GEOLSKIT42MAPS	GEOLSKIT42LAMS	42"	66	478	501	359	
GEOLSKIT48OAKS	GEOLSKIT48MAPS	GEOLSKIT48LAMS	48"	77	478	501	359	
1 Top, 1 Base, and 4 Shelves								
GEOLSKIT60OAKS	GEOLSKIT60MAPS	GEOLSKIT60LAMS	60-1/2"	83	675	708	504	
GEOLSKIT72OAKS	GEOLSKIT72MAPS	GEOLSKIT72LAMS	72"	87	675	708	504	
1 Top, 1 Base, 4 Shelves, and 1 Partition								Double-Faced
GEOLDKIT36OAKS	GEOLDKIT36MAPS	GEOLDKIT36LAMS	36"	102	\$1,093	\$1,149	\$ 821	
GEOLDKIT42OAKS	GEOLDKIT42MAPS	GEOLDKIT42LAMS	42"	120	1,093	1,149	821	
GEOLDKIT48OAKS	GEOLDKIT48MAPS	GEOLDKIT48LAMS	48"	139	1,093	1,149	821	
1 Top, 1 Base, 8 Shelves, and 1 Partition								
GEOLDKIT60OAKS	GEOLDKIT60MAPS	GEOLDKIT60LAMS	60-1/2"	148	1,590	1,670	1,193	
GEOLDKIT72OAKS	GEOLDKIT72MAPS	GEOLDKIT72LAMS	72"	154	1,590	1,670	1,193	

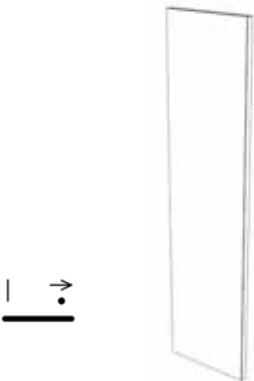

Please specify Wood Finish (Table 1) or Laminate (Table 4). Details can be found on page GEN 4 and GEN 5.

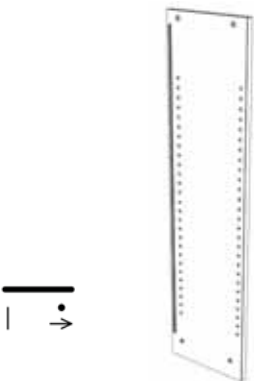
	Oak Catalog No.	Maple Catalog No.	Laminate Catalog No.	H x W x D	Wt. (lbs.)	Oak Price	Maple Price	Laminate Price
Single-Faced Left Panel 	GEOFSL36OAKS	GEOFSL36MAPS	GEOFSL36LAMS	36" x 1" x 12"	8	\$192	\$202	\$142
	GEOFSL42OAKS	GEOFSL42MAPS	GEOFSL42LAMS	42" x 1" x 12"	10	202	212	151
	GEOFSL48OAKS	GEOFSL48MAPS	GEOFSL48LAMS	48" x 1" x 12"	12	223	235	168
	GEOFSL60OAKS	GEOFSL60MAPS	GEOFSL60LAMS	60-1/2" x 1" x 12"	16	274	288	206
	GEOFSL72OAKS	GEOFSL72MAPS	GEOFSL72LAMS	72" x 1" x 12"	20	343	360	257

Single-Faced Right Panel 	GEOFSR36OAKS	GEOFSR36MAPS	GEOFSR36LAMS	36" x 1" x 12"	8	\$192	\$202	\$142
	GEOFSR42OAKS	GEOFSR42MAPS	GEOFSR42LAMS	42" x 1" x 12"	10	202	212	151
	GEOFSR48OAKS	GEOFSR48MAPS	GEOFSR48LAMS	48" x 1" x 12"	12	223	235	168
	GEOFSR60OAKS	GEOFSR60MAPS	GEOFSR60LAMS	60-1/2" x 1" x 12"	16	274	288	206
	GEOFSR72OAKS	GEOFSR72MAPS	GEOFSR72LAMS	72" x 1" x 12"	20	343	360	257



Double-Faced Panel 	GEOFD36OAKS	GEOFD36MAPS	GEOFD36LAMS	36" x 1" x 23"	16	\$305	\$320	\$226
	GEOFD42OAKS	GEOFD42MAPS	GEOFD42LAMS	42" x 1" x 23"	20	315	331	236
	GEOFD48OAKS	GEOFD48MAPS	GEOFD48LAMS	48" x 1" x 23"	24	362	380	272
	GEOFD60OAKS	GEOFD60MAPS	GEOFD60LAMS	60-1/2" x 1" x 23"	32	463	486	347
	GEOFD72OAKS	GEOFD72MAPS	GEOFD72LAMS	72" x 1" x 23"	40	560	588	420

Please specify Wood Finish (Table 1) or Laminate (Table 4). Details can be found on page GEN 4 and GEN 5.

Oak Catalog No.	Maple Catalog No.	Laminate Catalog No.	H x W x D	Wt. (lbs.)	Oak Price	Maple Price	Laminate Price	
<i>2 Adjustable Shelves and 1 Base Shelf per Side</i>								 <p>Linear Double-Faced Mobile, One Bay</p>
GEOMLDB360AKS	GEOMLDB36MAPS	GEOMLDB36LAMS	36" x 36" x 23"	138	\$1,977	\$2,076	\$1,480	
<i>2 Adjustable Shelves and 1 Base Shelf per Side</i>								
GEOMLDB420AKS	GEOMLDB42MAPS	GEOMLDB42LAMS	42" x 36" x 23"	164	1,987	2,086	1,490	
GEOMLDB480AKS	GEOMLDB48MAPS	GEOMLDB48LAMS	48" x 36" x 23"	191	2,128	2,234	1,596	
<i>4 Adjustable Shelves and 1 Base Shelf per Side</i>								
GEOMLDB600AKS	GEOMLDB60MAPS	GEOMLDB60LAMS	60-1/2" x 36" x 23"	216	2,700	2,835	2,025	
<i>2 Adjustable Shelves and 1 Base Shelf per Side</i>								 <p>Linear Double-Faced Mobile, Two Bay</p>
GEOMLDBB360AKS	GEOMLDBB36MAPS	GEOMLDBB36LAMS	36" x 72" x 23"	256	\$3,563	\$3,741	\$2,669	
<i>2 Adjustable Shelves and 1 Base Shelf per Side</i>								
GEOMLDBB420AKS	GEOMLDBB42MAPS	GEOMLDBB42LAMS	42" x 72" x 23"	304	3,573	3,752	2,680	
GEOMLDBB480AKS	GEOMLDBB48MAPS	GEOMLDBB48LAMS	48" x 72" x 23"	354	3,833	4,025	2,875	
<i>4 Adjustable Shelves and 1 Base Shelf per Side</i>								
GEOMLDBB600AKS	GEOMLDBB60MAPS	GEOMLDBB60LAMS	60-1/2" x 72" x 23"	396	4,860	5,103	3,645	

Please specify Wood Finish (Table 1) or Laminate (Table 4). Details can be found on page GEN 4 and GEN 5.

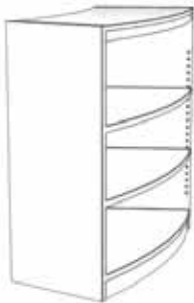
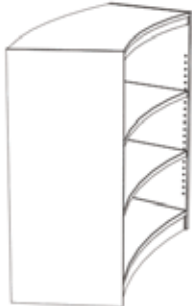
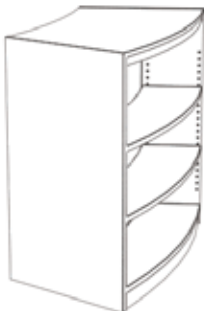
Note: Shelving Back Panels are sold separately on pages GEO 37-GEO 46.

	Oak Catalog No.	Maple Catalog No.	Laminate Catalog No.	H x W x D	Wt. (lbs.)	Oak Price	Maple Price	Laminate Price
Arc Convex Mobile Single-Faced 	<u>2 Adjustable Shelves and 1 Base Shelf</u>							
	GEOMAXS36OAKS	GEOMAXS36MAPS	GEOMAXS36LAMs	36" x 44" x 18"	148	\$1,752	\$1,840	\$1,313
	<u>2 Adjustable Shelves and 1 Base Shelf</u>							
	GEOMAXS42OAKS	GEOMAXS42MAPS	GEOMAXS42LAMs	42" x 44" x 18"	176	1,762	1,850	1,322
	GEOMAXS48OAKS	GEOMAXS48MAPS	GEOMAXS48LAMs	48" x 44" x 18"	206	1,860	1,954	1,394
	<hr/>							
Arc Concave Mobile Single-Faced 	<u>2 Adjustable Shelves and 1 Base Shelf</u>							
	GEOMAVS36OAKS	GEOMAVS36MAPS	GEOMAVS36LAMs	36" x 44" x 18"	148	\$1,752	\$1,840	\$1,313
	<u>2 Adjustable Shelves and 1 Base Shelf</u>							
	GEOMAVS42OAKS	GEOMAVS42MAPS	GEOMAVS42LAMs	42" x 44" x 18"	176	1,762	1,850	1,322
	GEOMAVS48OAKS	GEOMAVS48MAPS	GEOMAVS48LAMs	48" x 44" x 18"	206	1,860	1,954	1,394
	<hr/>							
Arc Double-Faced Mobile, One Bay 	<u>2 Adjustable Shelves and 1 Base Shelf per Side</u>							
	GEOMAD36OAKS	GEOMAD36MAPS	GEOMAD36LAMs	36" x 44" x 23"	158	\$2,434	\$2,556	\$1,823
	<u>2 Adjustable Shelves and 1 Base Shelf per Side</u>							
	GEOMAD42OAKS	GEOMAD42MAPS	GEOMAD42LAMs	42" x 44" x 23"	186	2,444	2,566	1,833
	GEOMAD48OAKS	GEOMAD48MAPS	GEOMAD48LAMs	48" x 44" x 23"	216	2,599	2,729	1,949
	<u>4 Adjustable Shelves and 1 Base Shelf per Side</u>							
GEOMAD60OAKS	GEOMAD60MAPS	GEOMAD60LAMs	60-1/2" x 44" x 23"	236	3,221	3,382	2,416	
<hr/>								
Arc Double-Faced Mobile, Two Bay 	<u>2 Adjustable Shelves and 1 Base Shelf per Side</u>							
	GEOMADBB36OAKS	GEOMADBB36MAPS	GEOMADBB36LAMs	36" x 88" x 23"	302	\$4,868	\$5,112	\$3,646
	<u>2 Adjustable Shelves and 1 Base Shelf per Side</u>							
	GEOMADBB42OAKS	GEOMADBB42MAPS	GEOMADBB42LAMs	42" x 88" x 23"	352	4,888	5,132	3,665
	GEOMADBB48OAKS	GEOMADBB48MAPS	GEOMADBB48LAMs	48" x 88" x 23"	408	5,198	5,458	3,898
	<u>4 Adjustable Shelves and 1 Base Shelf per Side</u>							
GEOMADBB60OAKS	GEOMADBB60MAPS	GEOMADBB60LAMs	60-1/2" x 88" x 23"	440	6,442	6,764	4,832	

Please specify Wood Finish (Table 1) or Laminate (Table 4). Details can be found on page GEN 4 and GEN 5.

Note: Shelving Back Panels are sold separately on pages GEO 37-GEO 46.

General Specifications

OAK AND MAPLE BACKS

Backs are constructed of 3-ply or 5-ply furniture-grade Oak or Maple veneered plywood finished on both sides to match shelving.

LAMINATE BACKS

Backs are constructed with 1/4" thick thermally-fused laminate panels.

WHITEBOARD BACKS

Whiteboards will be 1/32" thick and applied to oak, maple or laminate backs using heavy-duty glue.

MAGNETIC WHITEBOARD BACKS

Magnetic Whiteboards will be 1/32" thick and applied to oak, maple or laminate backs using heavy-duty glue.

TACKBOARD BACKS

Tackboards will be 1/4" thick and applied to oak, maple or laminate backs using heavy-duty glue.

UPHOLSTERED BACKS

Upholstered appliques will be 1/2" thick and applied to oak, maple or laminate backs using velcro strips. Quantity of velcro strips will be determined by size of upholstered back. Upholstered backs will be constructed using a 3/8" thick wood panel with a 1/4" thick foam piece covered with choice of Brodart fabrics.

Catalog No.	Description	H x W x D	Wt. (lbs.)	Price	
<i>36"H Shelving</i>					Linear Single-Faced Shelving
GEOLS036S	Oak Back Panel	31-5/8" x 35-5/8" x 1/4"	9	\$129	
GEOLSM36S	Maple Back Panel	31-5/8" x 35-5/8" x 1/4"	9	136	
GEOLSL36S	Laminate Back Panel	31-5/8" x 35-5/8" x 1/4"	9	96	
GEOLSW036S	Whiteboard/Oak Back Panel	31-5/8" x 35-5/8" x 1/4"	12.5	274	
GEOLSWM36S	Whiteboard/Maple Back Panel	31-5/8" x 35-5/8" x 1/4"	12.5	274	
GEOLSWL36S	Whiteboard/Laminate Back Panel	31-5/8" x 35-5/8" x 1/4"	12.5	274	
GEOLSM036S	Magnetic Whiteboard/Oak Back Panel	31-5/8" x 35-5/8" x 1/4"	13	365	
GEOLSM36S	Magnetic Whiteboard/Maple Back Panel	31-5/8" x 35-5/8" x 1/4"	13	365	
GEOLSM36S	Magnetic Whiteboard/Laminate Back Panel	31-5/8" x 35-5/8" x 1/4"	13	365	
GEOLST036S	Tackboard/Oak Back Panel	31-5/8" x 35-5/8" x 1/2"	16	293	
GEOLSTM36S	Tackboard/Maple Back Panel	31-5/8" x 35-5/8" x 1/2"	16	293	
GEOLSTL36S	Tackboard/Laminate Back Panel	31-5/8" x 35-5/8" x 1/2"	16	293	
GEOLSU036S	Upholstered/Oak Back Panel	31-5/8" x 35-5/8" x 3/4"	18	548	
GEOLSUM36S	Upholstered/Maple Back Panel	31-5/8" x 35-5/8" x 3/4"	18	548	
GEOLSUL36S	Upholstered/Laminate Back Panel	31-5/8" x 35-5/8" x 3/4"	18	548	
<i>42"H Shelving</i>					
GEOLS042S	Oak Back Panel	37-5/8" x 35-5/8" x 1/4"	12	\$139	
GEOLSM42S	Maple Back Panel	37-5/8" x 35-5/8" x 1/4"	12	147	
GEOLSL42S	Laminate Back Panel	37-5/8" x 35-5/8" x 1/4"	12	106	
GEOLSW042S	Whiteboard/Oak Back Panel	37-5/8" x 35-5/8" x 1/4"	16	326	
GEOLSWM42S	Whiteboard/Maple Back Panel	37-5/8" x 35-5/8" x 1/4"	16	326	
GEOLSWL42S	Whiteboard/Laminate Back Panel	37-5/8" x 35-5/8" x 1/4"	16	326	
GEOLSM042S	Magnetic Whiteboard/Oak Back Panel	37-5/8" x 35-5/8" x 1/4"	16.5	435	
GEOLSM42S	Magnetic Whiteboard/Maple Back Panel	37-5/8" x 35-5/8" x 1/4"	16.5	435	
GEOLSM42S	Magnetic Whiteboard/Laminate Back Panel	37-5/8" x 35-5/8" x 1/4"	16.5	435	
GEOLST042S	Tackboard/Oak Back Panel	37-5/8" x 35-5/8" x 1/2"	20	349	
GEOLSTM42S	Tackboard/Maple Back Panel	37-5/8" x 35-5/8" x 1/2"	20	349	
GEOLSTL42S	Tackboard/Laminate Back Panel	37-5/8" x 35-5/8" x 1/2"	20	349	
GEOLSU042S	Upholstered/Oak Back Panel	37-5/8" x 35-5/8" x 3/4"	23	652	
GEOLSUM42S	Upholstered/Maple Back Panel	37-5/8" x 35-5/8" x 3/4"	23	652	
GEOLSUL42S	Upholstered/Laminate Back Panel	37-5/8" x 35-5/8" x 3/4"	23	652	

Please specify Wood Finish (Table 1) or Laminate (Table 4). Details can be found on page GEN 4 and GEN 5.

	Catalog No.	Description	H x W x D	Wt. (lbs.)	Price	
Linear Single-Faced Shelving	<i>48"H Shelving</i>					
		GEOLSO48S	Oak Back Panel	43-5/8" x 35-5/8" x 1/4"	15	\$152
		GEOLSM48S	Maple Back Panel	43-5/8" x 35-5/8" x 1/4"	15	159
		GEOLSL48S	Laminate Back Panel	43-5/8" x 35-5/8" x 1/4"	15	115
		GEOLSWO48S	Whiteboard/Oak Back Panel	43-5/8" x 35-5/8" x 1/4"	19.5	356
		GEOLSWM48S	Whiteboard/Maple Back Panel	43-5/8" x 35-5/8" x 1/4"	19.5	356
		GEOLSWL48S	Whiteboard/Laminate Back Panel	43-5/8" x 35-5/8" x 1/4"	19.5	356
		GEOLSMO48S	Magnetic Whiteboard/Oak Back Panel	43-5/8" x 35-5/8" x 1/4"	20	475
		GEOLSMM48S	Magnetic Whiteboard/Maple Back Panel	43-5/8" x 35-5/8" x 1/4"	20	475
		GEOLSML48S	Magnetic Whiteboard/Laminate Back Panel	43-5/8" x 35-5/8" x 1/4"	20	475
		GEOLSTO48S	Tackboard/Oak Back Panel	43-5/8" x 35-5/8" x 1/2"	24	381
		GEOLSTM48S	Tackboard/Maple Back Panel	43-5/8" x 35-5/8" x 1/2"	24	381
		GEOLSTL48S	Tackboard/Laminate Back Panel	43-5/8" x 35-5/8" x 1/2"	24	381
		GEOLSUO48S	Upholstered/Oak Back Panel	43-5/8" x 35-5/8" x 3/4"	28	712
		GEOLSUM48S	Upholstered/Maple Back Panel	43-5/8" x 35-5/8" x 3/4"	28	712
		GEOLSUL48S	Upholstered/Laminate Back Panel	43-5/8" x 35-5/8" x 3/4"	28	712
		<i>60-1/2"H Shelving</i>				
		GEOLSO60S	Oak Back Panel	56-1/8" x 35-5/8" x 1/4"	18	\$ 206
		GEOLSM60S	Maple Back Panel	56-1/8" x 35-5/8" x 1/4"	18	216
		GEOLSL60S	Laminate Back Panel	56-1/8" x 35-5/8" x 1/4"	18	156
		GEOLSWO60S	Whiteboard/Oak Back Panel	56-1/8" x 35-5/8" x 1/4"	23.5	536
		GEOLSWM60S	Whiteboard/Maple Back Panel	56-1/8" x 35-5/8" x 1/4"	23.5	536
		GEOLSWL60S	Whiteboard/Laminate Back Panel	56-1/8" x 35-5/8" x 1/4"	23.5	536
		GEOLSMO60S	Magnetic Whiteboard/Oak Back Panel	56-1/8" x 35-5/8" x 1/4"	24	714
		GEOLSMM60S	Magnetic Whiteboard/Maple Back Panel	56-1/8" x 35-5/8" x 1/4"	24	714
		GEOLSML60S	Magnetic Whiteboard/Laminate Back Panel	56-1/8" x 35-5/8" x 1/4"	24	714
		GEOLSTO60S	Tackboard/Oak Back Panel	56-1/8" x 35-5/8" x 1/2"	29	574
		GEOLSTM60S	Tackboard/Maple Back Panel	56-1/8" x 35-5/8" x 1/2"	29	574
		GEOLSTL60S	Tackboard/Laminate Back Panel	56-1/8" x 35-5/8" x 1/2"	29	574
		GEOLSUO60S	Upholstered/Oak Back Panel	56-1/8" x 35-5/8" x 3/4"	36	1,072
		GEOLSUM60S	Upholstered/Maple Back Panel	56-1/8" x 35-5/8" x 3/4"	36	1,072
		GEOLSUL60S	Upholstered/Laminate Back Panel	56-1/8" x 35-5/8" x 3/4"	36	1,072
		<i>72"H Shelving</i>				
		GEOLSO72S	Oak Back Panel	66-1/8" x 35-5/8" x 1/4"	20	\$ 223
		GEOLSM72S	Maple Back Panel	66-1/8" x 35-5/8" x 1/4"	20	234
		GEOLSL72S	Laminate Back Panel	66-1/8" x 35-5/8" x 1/4"	20	168
		GEOLSWO72S	Whiteboard/Oak Back Panel	66-1/8" x 35-5/8" x 1/4"	26.5	556
		GEOLSWM72S	Whiteboard/Maple Back Panel	66-1/8" x 35-5/8" x 1/4"	26.5	556
		GEOLSWL72S	Whiteboard/Laminate Back Panel	66-1/8" x 35-5/8" x 1/4"	26.5	556
		GEOLSMO72S	Magnetic Whiteboard/Oak Back Panel	66-1/8" x 35-5/8" x 1/4"	27	741
		GEOLSMM72S	Magnetic Whiteboard/Maple Back Panel	66-1/8" x 35-5/8" x 1/4"	27	741
		GEOLSML72S	Magnetic Whiteboard/Laminate Back Panel	66-1/8" x 35-5/8" x 1/4"	27	741
		GEOLSTO72S	Tackboard/Oak Back Panel	66-1/8" x 35-5/8" x 1/2"	34	595
		GEOLSTM72S	Tackboard/Maple Back Panel	66-1/8" x 35-5/8" x 1/2"	34	595
		GEOLSTL72S	Tackboard/Laminate Back Panel	66-1/8" x 35-5/8" x 1/2"	34	595
		GEOLSUO72S	Upholstered/Oak Back Panel	66-1/8" x 35-5/8" x 3/4"	42	1,112
		GEOLSUM72S	Upholstered/Maple Back Panel	66-1/8" x 35-5/8" x 3/4"	42	1,112
		GEOLSUL72S	Upholstered/Laminate Back Panel	66-1/8" x 35-5/8" x 3/4"	42	1,112

Please specify Wood Finish (Table 1) or Laminate (Table 4). Details can be found on page GEN 4 and GEN 5.

Catalog No.	Description	H x W x D	Wt. (lbs.)	Price	Arc Convex Single-Faced Shelving
<i>36"H Shelving</i>					
GEOAXS036S	Oak Back Panel	31-5/8" x 36-15/16" x 1/4"	9	\$129	
GEOAXSM36S	Maple Back Panel	31-5/8" x 36-15/16" x 1/4"	9	136	
GEOAXSL36S	Laminate Back Panel	31-5/8" x 36-15/16" x 1/4"	9	96	
GEOAXSW036S	Whiteboard/Oak Back Panel	31-5/8" x 36-15/16" x 1/4"	12.5	274	
GEOAXSWM36S	Whiteboard/Maple Back Panel	31-5/8" x 36-15/16" x 1/4"	12.5	274	
GEOAXSWL36S	Whiteboard/Laminate Back Panel	31-5/8" x 36-15/16" x 1/4"	12.5	274	
GEOAXSTO36S	Tackboard/Oak Back Panel	31-5/8" x 36-15/16" x 1/2"	16	293	
GEOAXSTM36S	Tackboard/Maple Back Panel	31-5/8" x 36-15/16" x 1/2"	16	293	
GEOAXSTL36S	Tackboard/Laminate Back Panel	31-5/8" x 36-15/16" x 1/2"	16	293	
GEOAXSU036S	Upholstered/Oak Back Panel	31-5/8" x 36-15/16" x 3/4"	18	548	
GEOAXSUM36S	Upholstered/Maple Back Panel	31-5/8" x 36-15/16" x 3/4"	18	548	
GEOAXSUL36S	Upholstered/Laminate Back Panel	31-5/8" x 36-15/16" x 3/4"	18	548	
<i>42"H Shelving</i>					
GEOAXS042S	Oak Back Panel	37-5/8" x 36-15/16" x 1/4"	12	\$139	
GEOAXSM42S	Maple Back Panel	37-5/8" x 36-15/16" x 1/4"	12	147	
GEOAXSL42S	Laminate Back Panel	37-5/8" x 36-15/16" x 1/4"	12	106	
GEOAXSW042S	Whiteboard/Oak Back Panel	37-5/8" x 36-15/16" x 1/4"	16	326	
GEOAXSWM42S	Whiteboard/Maple Back Panel	37-5/8" x 36-15/16" x 1/4"	16	326	
GEOAXSWL42S	Whiteboard/Laminate Back Panel	37-5/8" x 36-15/16" x 1/4"	16	326	
GEOAXSTO42S	Tackboard/Oak Back Panel	37-5/8" x 36-15/16" x 1/2"	20	349	
GEOAXSTM42S	Tackboard/Maple Back Panel	37-5/8" x 36-15/16" x 1/2"	20	349	
GEOAXSTL42S	Tackboard/Laminate Back Panel	37-5/8" x 36-15/16" x 1/2"	20	349	
GEOAXSU042S	Upholstered/Oak Back Panel	37-5/8" x 36-15/16" x 3/4"	23	652	
GEOAXSUM42S	Upholstered/Maple Back Panel	37-5/8" x 36-15/16" x 3/4"	23	652	
GEOAXSUL42S	Upholstered/Laminate Back Panel	37-5/8" x 36-15/16" x 3/4"	23	652	
<i>48"H Shelving</i>					
GEOAXS048S	Oak Back Panel	43-5/8" x 36-15/16" x 1/4"	15	\$152	
GEOAXSM48S	Maple Back Panel	43-5/8" x 36-15/16" x 1/4"	15	159	
GEOAXSL48S	Laminate Back Panel	43-5/8" x 36-15/16" x 1/4"	15	115	
GEOAXSW048S	Whiteboard/Oak Back Panel	43-5/8" x 36-15/16" x 1/4"	19.5	356	
GEOAXSWM48S	Whiteboard/Maple Back Panel	43-5/8" x 36-15/16" x 1/4"	19.5	356	
GEOAXSWL48S	Whiteboard/Laminate Back Panel	43-5/8" x 36-15/16" x 1/4"	19.5	356	
GEOAXSTO48S	Tackboard/Oak Back Panel	43-5/8" x 36-15/16" x 1/2"	24	381	
GEOAXSTM48S	Tackboard/Maple Back Panel	43-5/8" x 36-15/16" x 1/2"	24	381	
GEOAXSTL48S	Tackboard/Laminate Back Panel	43-5/8" x 36-15/16" x 1/2"	24	381	
GEOAXSU048S	Upholstered/Oak Back Panel	43-5/8" x 36-15/16" x 3/4"	28	712	
GEOAXSUM48S	Upholstered/Maple Back Panel	43-5/8" x 36-15/16" x 3/4"	28	712	
GEOAXSUL48S	Upholstered/Laminate Back Panel	43-5/8" x 36-15/16" x 3/4"	28	712	

Please specify Wood Finish (Table 1) or Laminate (Table 4). Details can be found on page GEN 4 and GEN 5.

	Catalog No.	Description	H x W x D	Wt. (lbs.)	Price
Arc Convex Single-Faced Shelving	<u>60-1/2"H Shelving</u>				
	GEOAXS060S	Oak Back Panel	56-1/8" x 36-15/16" x 1/4"	18	\$ 206
	GEOAXSM60S	Maple Back Panel	56-1/8" x 36-15/16" x 1/4"	18	216
	GEOAXSL60S	Laminate Back Panel	56-1/8" x 36-15/16" x 1/4"	18	156
	GEOAXSW060S	Whiteboard/Oak Back Panel	56-1/8" x 36-15/16" x 1/4"	23.5	536
	GEOAXSWM60S	Whiteboard/Maple Back Panel	56-1/8" x 36-15/16" x 1/4"	23.5	536
	GEOAXSWL60S	Whiteboard/Laminate Back Panel	56-1/8" x 36-15/16" x 1/4"	23.5	536
	GEOAXST060S	Tackboard/Oak Back Panel	56-1/8" x 36-15/16" x 1/2"	29	574
	GEOAXSTM60S	Tackboard/Maple Back Panel	56-1/8" x 36-15/16" x 1/2"	29	574
	GEOAXSTL60S	Tackboard/Laminate Back Panel	56-1/8" x 36-15/16" x 1/2"	29	574
	GEOAXSU060S	Upholstered/Oak Back Panel	56-1/8" x 36-15/16" x 3/4"	36	1,072
	GEOAXSUM60S	Upholstered/Maple Back Panel	56-1/8" x 36-15/16" x 3/4"	36	1,072
	GEOAXSUL60S	Upholstered/Laminate Back Panel	56-1/8" x 36-15/16" x 3/4"	36	1,072
	<u>72"H Shelving</u>				
	GEOAXS072S	Oak Back Panel	66-1/8" x 36-15/16" x 1/4"	20	\$ 223
	GEOAXSM72S	Maple Back Panel	66-1/8" x 36-15/16" x 1/4"	20	234
	GEOAXSL72S	Laminate Back Panel	66-1/8" x 36-15/16" x 1/4"	20	168
	GEOAXSW072S	Whiteboard/Oak Back Panel	66-1/8" x 36-15/16" x 1/4"	26.5	556
	GEOAXSWM72S	Whiteboard/Maple Back Panel	66-1/8" x 36-15/16" x 1/4"	26.5	556
GEOAXSWL72S	Whiteboard/Laminate Back Panel	66-1/8" x 36-15/16" x 1/4"	26.5	556	
GEOAXST072S	Tackboard/Oak Back Panel	66-1/8" x 36-15/16" x 1/2"	34	595	
GEOAXSTM72S	Tackboard/Maple Back Panel	66-1/8" x 36-15/16" x 1/2"	34	595	
GEOAXSTL72S	Tackboard/Laminate Back Panel	66-1/8" x 36-15/16" x 1/2"	34	595	
GEOAXSU072S	Upholstered/Oak Back Panel	66-1/8" x 36-15/16" x 3/4"	42	1,112	
GEOAXSUM72S	Upholstered/Maple Back Panel	66-1/8" x 36-15/16" x 3/4"	42	1,112	
GEOAXSUL72S	Upholstered/Laminate Back Panel	66-1/8" x 36-15/16" x 3/4"	42	1,112	

Please specify Wood Finish (Table 1) or Laminate (Table 4). Details can be found on page GEN 4 and GEN 5.

Catalog No.	Description	H x W x D	Wt. (lbs.)	Price	
<i>36"H Shelving</i>					Arc Concave Single-Faced Shelving Type 1 (44"W)
GEOAV1SO36S	Oak Back Panel	31-5/8" x 42-5/8" x 1/4"	10.5	\$129	
GEOAV1SM36S	Maple Back Panel	31-5/8" x 42-5/8" x 1/4"	10.5	136	
GEOAV1SL36S	Laminate Back Panel	31-5/8" x 42-5/8" x 1/4"	10.5	96	
GEOAV1SWO36S	Whiteboard/Oak Back Panel	31-5/8" x 42-5/8" x 1/4"	14	299	
GEOAV1SWM36S	Whiteboard/Maple Back Panel	31-5/8" x 42-5/8" x 1/4"	14	299	
GEOAV1SWL36S	Whiteboard/Laminate Back Panel	31-5/8" x 42-5/8" x 1/4"	14	299	
GEOAV1STO36S	Tackboard/Oak Back Panel	31-5/8" x 42-5/8" x 1/2"	19	320	
GEOAV1STM36S	Tackboard/Maple Back Panel	31-5/8" x 42-5/8" x 1/2"	19	320	
GEOAV1STL36S	Tackboard/Laminate Back Panel	31-5/8" x 42-5/8" x 1/2"	19	320	
GEOAV1SUO36S	Upholstered/Oak Back Panel	31-5/8" x 42-5/8" x 3/4"	20	593	
GEOAV1SUM36S	Upholstered/Maple Back Panel	31-5/8" x 42-5/8" x 3/4"	20	593	
GEOAV1SUL36S	Upholstered/Laminate Back Panel	31-5/8" x 42-5/8" x 3/4"	20	593	
<i>42"H Shelving</i>					
GEOAV1SO42S	Oak Back Panel	37-5/8" x 42-5/8" x 1/4"	13.5	\$139	
GEOAV1SM42S	Maple Back Panel	37-5/8" x 42-5/8" x 1/4"	13.5	147	
GEOAV1SL42S	Laminate Back Panel	37-5/8" x 42-5/8" x 1/4"	13.5	106	
GEOAV1SWO42S	Whiteboard/Oak Back Panel	37-5/8" x 42-5/8" x 1/4"	17.5	351	
GEOAV1SWM42S	Whiteboard/Maple Back Panel	37-5/8" x 42-5/8" x 1/4"	17.5	351	
GEOAV1SWL42S	Whiteboard/Laminate Back Panel	37-5/8" x 42-5/8" x 1/4"	17.5	351	
GEOAV1STO42S	Tackboard/Oak Back Panel	37-5/8" x 42-5/8" x 1/2"	23	375	
GEOAV1STM42S	Tackboard/Maple Back Panel	37-5/8" x 42-5/8" x 1/2"	23	375	
GEOAV1STL42S	Tackboard/Laminate Back Panel	37-5/8" x 42-5/8" x 1/2"	23	375	
GEOAV1SUO42S	Upholstered/Oak Back Panel	37-5/8" x 42-5/8" x 3/4"	25	697	
GEOAV1SUM42S	Upholstered/Maple Back Panel	37-5/8" x 42-5/8" x 3/4"	25	697	
GEOAV1SUL42S	Upholstered/Laminate Back Panel	37-5/8" x 42-5/8" x 3/4"	25	697	
<i>48"H Shelving</i>					
GEOAV1SO48S	Oak Back Panel	43-5/8" x 42-5/8" x 1/4"	16.5	\$152	
GEOAV1SM48S	Maple Back Panel	43-5/8" x 42-5/8" x 1/4"	16.5	159	
GEOAV1SL48S	Laminate Back Panel	43-5/8" x 42-5/8" x 1/4"	16.5	115	
GEOAV1SWO48S	Whiteboard/Oak Back Panel	43-5/8" x 42-5/8" x 1/4"	21	381	
GEOAV1SWM48S	Whiteboard/Maple Back Panel	43-5/8" x 42-5/8" x 1/4"	21	381	
GEOAV1SWL48S	Whiteboard/Laminate Back Panel	43-5/8" x 42-5/8" x 1/4"	21	381	
GEOAV1STO48S	Tackboard/Oak Back Panel	43-5/8" x 42-5/8" x 1/2"	27	407	
GEOAV1STM48S	Tackboard/Maple Back Panel	43-5/8" x 42-5/8" x 1/2"	27	407	
GEOAV1STL48S	Tackboard/Laminate Back Panel	43-5/8" x 42-5/8" x 1/2"	27	407	
GEOAV1SUO48S	Upholstered/Oak Back Panel	43-5/8" x 42-5/8" x 3/4"	30	757	
GEOAV1SUM48S	Upholstered/Maple Back Panel	43-5/8" x 42-5/8" x 3/4"	30	757	
GEOAV1SUL48S	Upholstered/Laminate Back Panel	43-5/8" x 42-5/8" x 3/4"	30	757	

Please specify Wood Finish (Table 1) or Laminate (Table 4). Details can be found on page GEN 4 and GEN 5.

	Catalog No.	Description	H x W x D	Wt. (lbs.)	Price
Arc Concave Single-Faced Shelving Type 1 (44"W)	<u>60-1/2"H Shelving</u>				
	GEOAV1SO60S	Oak Back Panel	56-1/8" x 42-5/8" x 1/4"	19.5	\$ 206
	GEOAV1SM60S	Maple Back Panel	56-1/8" x 42-5/8" x 1/4"	19.5	216
	GEOAV1SL60S	Laminate Back Panel	56-1/8" x 42-5/8" x 1/4"	19.5	156
	GEOAV1SWO60S	Whiteboard/Oak Back Panel	56-1/8" x 42-5/8" x 1/4"	25	561
	GEOAV1SWM60S	Whiteboard/Maple Back Panel	56-1/8" x 42-5/8" x 1/4"	25	561
	GEOAV1SWL60S	Whiteboard/Laminate Back Panel	56-1/8" x 42-5/8" x 1/4"	25	561
	GEOAV1STO60S	Tackboard/Oak Back Panel	56-1/8" x 42-5/8" x 1/2"	32	600
	GEOAV1STM60S	Tackboard/Maple Back Panel	56-1/8" x 42-5/8" x 1/2"	32	600
	GEOAV1STL60S	Tackboard/Laminate Back Panel	56-1/8" x 42-5/8" x 1/2"	32	600
	GEOAV1SUO60S	Upholstered/Oak Back Panel	56-1/8" x 42-5/8" x 3/4"	38	1,117
	GEOAV1SUM60S	Upholstered/Maple Back Panel	56-1/8" x 42-5/8" x 3/4"	38	1,117
	GEOAV1SUL60S	Upholstered/Laminate Back Panel	56-1/8" x 42-5/8" x 3/4"	38	1,117
		<u>72"H Shelving</u>			
GEOAV1SO72S		Oak Back Panel	66-1/8" x 42-5/8" x 1/4"	21.5	\$ 223
GEOAV1SM72S		Maple Back Panel	66-1/8" x 42-5/8" x 1/4"	21.5	234
GEOAV1SL72S		Laminate Back Panel	66-1/8" x 42-5/8" x 1/4"	21.5	168
GEOAV1SWO72S		Whiteboard/Oak Back Panel	66-1/8" x 42-5/8" x 1/4"	28	581
GEOAV1SWM72S		Whiteboard/Maple Back Panel	66-1/8" x 42-5/8" x 1/4"	28	581
GEOAV1SWL72S		Whiteboard/Laminate Back Panel	66-1/8" x 42-5/8" x 1/4"	28	581
GEOAV1STO72S		Tackboard/Oak Back Panel	66-1/8" x 42-5/8" x 1/2"	37	621
GEOAV1STM72S		Tackboard/Maple Back Panel	66-1/8" x 42-5/8" x 1/2"	37	621
GEOAV1STL72S		Tackboard/Laminate Back Panel	66-1/8" x 42-5/8" x 1/2"	37	621
GEOAV1SUO72S		Upholstered/Oak Back Panel	66-1/8" x 42-5/8" x 3/4"	44	1,157
GEOAV1SUM72S		Upholstered/Maple Back Panel	66-1/8" x 42-5/8" x 3/4"	44	1,157
GEOAV1SUL72S		Upholstered/Laminate Back Panel	66-1/8" x 42-5/8" x 3/4"	44	1,157

Please specify Wood Finish (Table 1) or Laminate (Table 4). Details can be found on page GEN 4 and GEN 5.

Catalog No.	Description	H x W x D	Wt. (lbs.)	Price	
<i>36"H Shelving</i>					Arc Concave Single-Faced Shelving Type 2 (37"W)
GEOAV2S036S	Oak Back Panel	31-5/8" x 36-23/32" x 1/4"	9.5	\$129	
GEOAV2SM36S	Maple Back Panel	31-5/8" x 36-23/32" x 1/4"	9.5	136	
GEOAV2SL36S	Laminate Back Panel	31-5/8" x 36-23/32" x 1/4"	9.5	96	
GEOAV2SWO36S	Whiteboard/Oak Back Panel	31-5/8" x 36-23/32" x 1/4"	13	294	
GEOAV2SWM36S	Whiteboard/Maple Back Panel	31-5/8" x 36-23/32" x 1/4"	13	294	
GEOAV2SWL36S	Whiteboard/Laminate Back Panel	31-5/8" x 36-23/32" x 1/4"	13	294	
GEOAV2STO36S	Tackboard/Oak Back Panel	31-5/8" x 36-23/32" x 1/2"	18	315	
GEOAV2STM36S	Tackboard/Maple Back Panel	31-5/8" x 36-23/32" x 1/2"	18	315	
GEOAV2STL36S	Tackboard/Laminate Back Panel	31-5/8" x 36-23/32" x 1/2"	18	315	
GEOAV2SUO36S	Upholstered/Oak Back Panel	31-5/8" x 36-23/32" x 3/4"	19	588	
GEOAV2SUM36S	Upholstered/Maple Back Panel	31-5/8" x 36-23/32" x 3/4"	19	588	
GEOAV2SUL36S	Upholstered/Laminate Back Panel	31-5/8" x 36-23/32" x 3/4"	19	588	
<i>42"H Shelving</i>					
GEOAV2S042S	Oak Back Panel	37-5/8" x 36-23/32" x 1/4"	12.5	\$139	
GEOAV2SM42S	Maple Back Panel	37-5/8" x 36-23/32" x 1/4"	12.5	147	
GEOAV2SL42S	Laminate Back Panel	37-5/8" x 36-23/32" x 1/4"	12.5	106	
GEOAV2SWO42S	Whiteboard/Oak Back Panel	37-5/8" x 36-23/32" x 1/4"	16.5	346	
GEOAV2SWM42S	Whiteboard/Maple Back Panel	37-5/8" x 36-23/32" x 1/4"	16.5	346	
GEOAV2SWL42S	Whiteboard/Laminate Back Panel	37-5/8" x 36-23/32" x 1/4"	16.5	346	
GEOAV2STO42S	Tackboard/Oak Back Panel	37-5/8" x 36-23/32" x 1/2"	22	370	
GEOAV2STM42S	Tackboard/Maple Back Panel	37-5/8" x 36-23/32" x 1/2"	22	370	
GEOAV2STL42S	Tackboard/Laminate Back Panel	37-5/8" x 36-23/32" x 1/2"	22	370	
GEOAV2SUO42S	Upholstered/Oak Back Panel	37-5/8" x 36-23/32" x 3/4"	24	692	
GEOAV2SUM42S	Upholstered/Maple Back Panel	37-5/8" x 36-23/32" x 3/4"	24	692	
GEOAV2SUL42S	Upholstered/Laminate Back Panel	37-5/8" x 36-23/32" x 3/4"	24	692	
<i>48"H Shelving</i>					
GEOAV2S048S	Oak Back Panel	43-5/8" x 36-23/32" x 1/4"	15.5	\$152	
GEOAV2SM48S	Maple Back Panel	43-5/8" x 36-23/32" x 1/4"	15.5	159	
GEOAV2SL48S	Laminate Back Panel	43-5/8" x 36-23/32" x 1/4"	15.5	115	
GEOAV2SWO48S	Whiteboard/Oak Back Panel	43-5/8" x 36-23/32" x 1/4"	20	376	
GEOAV2SWM48S	Whiteboard/Maple Back Panel	43-5/8" x 36-23/32" x 1/4"	20	376	
GEOAV2SWL48S	Whiteboard/Laminate Back Panel	43-5/8" x 36-23/32" x 1/4"	20	376	
GEOAV2STO48S	Tackboard/Oak Back Panel	43-5/8" x 36-23/32" x 1/2"	26	402	
GEOAV2STM48S	Tackboard/Maple Back Panel	43-5/8" x 36-23/32" x 1/2"	26	402	
GEOAV2STL48S	Tackboard/Laminate Back Panel	43-5/8" x 36-23/32" x 1/2"	26	402	
GEOAV2SUO48S	Upholstered/Oak Back Panel	43-5/8" x 36-23/32" x 3/4"	29	752	
GEOAV2SUM48S	Upholstered/Maple Back Panel	43-5/8" x 36-23/32" x 3/4"	29	752	
GEOAV2SUL48S	Upholstered/Laminate Back Panel	43-5/8" x 36-23/32" x 3/4"	29	752	

Please specify Wood Finish (Table 1) or Laminate (Table 4). Details can be found on page GEN 4 and GEN 5.

	Catalog No.	Description	H x W x D	Wt. (lbs.)	Price
Arc Concave Single-Faced Shelving Type 2 (37"W)	<u>60-1/2"H Shelving</u>				
	GEOAV2S060S	Oak Back Panel	56-5/8" x 36-23/32" x 1/4"	18.5	\$ 206
	GEOAV2SM60S	Maple Back Panel	56-5/8" x 36-23/32" x 1/4"	18.5	216
	GEOAV2SL60S	Laminate Back Panel	56-5/8" x 36-23/32" x 1/4"	18.5	156
	GEOAV2SW060S	Whiteboard/Oak Back Panel	56-5/8" x 36-23/32" x 1/4"	24	556
	GEOAV2SWM60S	Whiteboard/Maple Back Panel	56-5/8" x 36-23/32" x 1/4"	24	556
	GEOAV2SWL60S	Whiteboard/Laminate Back Panel	56-5/8" x 36-23/32" x 1/4"	24	556
	GEOAV2STO60S	Tackboard/Oak Back Panel	56-5/8" x 36-23/32" x 1/2"	31	595
	GEOAV2STM60S	Tackboard/Maple Back Panel	56-5/8" x 36-23/32" x 1/2"	31	595
	GEOAV2STL60S	Tackboard/Laminate Back Panel	56-5/8" x 36-23/32" x 1/2"	31	595
	GEOAV2SU060S	Upholstered/Oak Back Panel	56-5/8" x 36-23/32" x 3/4"	37	1,112
	GEOAV2SUM60S	Upholstered/Maple Back Panel	56-5/8" x 36-23/32" x 3/4"	37	1,112
	GEOAV2SUL60S	Upholstered/Laminate Back Panel	56-5/8" x 36-23/32" x 3/4"	37	1,112
		<u>72"H Shelving</u>			
GEOAV2S072S		Oak Back Panel	66-5/8" x 36-23/32" x 1/4"	20.5	\$ 223
GEOAV2SM72S		Maple Back Panel	66-5/8" x 36-23/32" x 1/4"	20.5	234
GEOAV2SL72S		Laminate Back Panel	66-5/8" x 36-23/32" x 1/4"	20.5	168
GEOAV2SW072S		Whiteboard/Oak Back Panel	66-5/8" x 36-23/32" x 1/4"	27	576
GEOAV2SWM72S		Whiteboard/Maple Back Panel	66-5/8" x 36-23/32" x 1/4"	27	576
GEOAV2SWL72S		Whiteboard/Laminate Back Panel	66-5/8" x 36-23/32" x 1/4"	27	576
GEOAV2STO72S		Tackboard/Oak Back Panel	66-5/8" x 36-23/32" x 1/2"	36	616
GEOAV2STM72S		Tackboard/Maple Back Panel	66-5/8" x 36-23/32" x 1/2"	36	616
GEOAV2STL72S		Tackboard/Laminate Back Panel	66-5/8" x 36-23/32" x 1/2"	36	616
GEOAV2SU072S		Upholstered/Oak Back Panel	66-5/8" x 36-23/32" x 3/4"	43	1,152
GEOAV2SUM72S		Upholstered/Maple Back Panel	66-5/8" x 36-23/32" x 3/4"	43	1,152
GEOAV2SUL72S		Upholstered/Laminate Back Panel	66-5/8" x 36-23/32" x 3/4"	43	1,152

Please specify Wood Finish (Table 1) or Laminate (Table 4). Details can be found on page GEN 4 and GEN 5.

Catalog No.	Description	H x W x D	Wt. (lbs.)	Price	
<i>36"H Shelving</i>					Mobile Arc Convex Single-Faced Shelving
GEOMAXSO36S	Oak Back Panel	31-3/16" x 36-17/32" x 1/4"	9	\$129	
GEOMAXSM36S	Maple Back Panel	31-3/16" x 36-17/32" x 1/4"	9	136	
GEOMAXSL36S	Laminate Back Panel	31-3/16" x 36-17/32" x 1/4"	9	96	
GEOMAXSWO36S	Whiteboard/Oak Back Panel	31-3/16" x 36-17/32" x 1/4"	12.5	274	
GEOMAXSWM36S	Whiteboard/Maple Back Panel	31-3/16" x 36-17/32" x 1/4"	12.5	274	
GEOMAXSWL36S	Whiteboard/Laminate Back Panel	31-3/16" x 36-17/32" x 1/4"	12.5	274	
GEOMAXSTO36S	Tackboard/Oak Back Panel	31-3/16" x 36-17/32" x 1/2"	16	293	
GEOMAXSTM36S	Tackboard/Maple Back Panel	31-3/16" x 36-17/32" x 1/2"	16	293	
GEOMAXSTL36S	Tackboard/Laminate Back Panel	31-3/16" x 36-17/32" x 1/2"	16	293	
GEOMAXSUO36S	Upholstered/Oak Back Panel	31-3/16" x 36-17/32" x 3/4"	18	548	
GEOMAXSUM36S	Upholstered/Maple Back Panel	31-3/16" x 36-17/32" x 3/4"	18	548	
GEOMAXSUL36S	Upholstered/Laminate Back Panel	31-3/16" x 36-17/32" x 3/4"	18	548	
<i>42"H Shelving</i>					
GEOMAXSO42S	Oak Back Panel	37-3/16" x 36-17/32" x 1/4"	12	\$139	
GEOMAXSM42S	Maple Back Panel	37-3/16" x 36-17/32" x 1/4"	12	147	
GEOMAXSL42S	Laminate Back Panel	37-3/16" x 36-17/32" x 1/4"	12	106	
GEOMAXSWO42S	Whiteboard/Oak Back Panel	37-3/16" x 36-17/32" x 1/4"	16	326	
GEOMAXSWM42S	Whiteboard/Maple Back Panel	37-3/16" x 36-17/32" x 1/4"	16	326	
GEOMAXSWL42S	Whiteboard/Laminate Back Panel	37-3/16" x 36-17/32" x 1/4"	16	326	
GEOMAXSTO42S	Tackboard/Oak Back Panel	37-3/16" x 36-17/32" x 1/2"	20	349	
GEOMAXSTM42S	Tackboard/Maple Back Panel	37-3/16" x 36-17/32" x 1/2"	20	349	
GEOMAXSTL42S	Tackboard/Laminate Back Panel	37-3/16" x 36-17/32" x 1/2"	20	349	
GEOMAXSUO42S	Upholstered/Oak Back Panel	37-3/16" x 36-17/32" x 3/4"	23	652	
GEOMAXSUM42S	Upholstered/Maple Back Panel	37-3/16" x 36-17/32" x 3/4"	23	652	
GEOMAXSUL42S	Upholstered/Laminate Back Panel	37-3/16" x 36-17/32" x 3/4"	23	652	
<i>48"H Shelving</i>					
GEOMAXSO48S	Oak Back Panel	43-3/16" x 36-17/32" x 1/4"	15	\$152	
GEOMAXSM48S	Maple Back Panel	43-3/16" x 36-17/32" x 1/4"	15	159	
GEOMAXSL48S	Laminate Back Panel	43-3/16" x 36-17/32" x 1/4"	15	115	
GEOMAXSWO48S	Whiteboard/Oak Back Panel	43-3/16" x 36-17/32" x 1/4"	19.5	356	
GEOMAXSWM48S	Whiteboard/Maple Back Panel	43-3/16" x 36-17/32" x 1/4"	19.5	356	
GEOMAXSWL48S	Whiteboard/Laminate Back Panel	43-3/16" x 36-17/32" x 1/4"	19.5	356	
GEOMAXSTO48S	Tackboard/Oak Back Panel	43-3/16" x 36-17/32" x 1/2"	24	381	
GEOMAXSTM48S	Tackboard/Maple Back Panel	43-3/16" x 36-17/32" x 1/2"	24	381	
GEOMAXSTL48S	Tackboard/Laminate Back Panel	43-3/16" x 36-17/32" x 1/2"	24	381	
GEOMAXSUO48S	Upholstered/Oak Back Panel	43-3/16" x 36-17/32" x 3/4"	28	712	
GEOMAXSUM48S	Upholstered/Maple Back Panel	43-3/16" x 36-17/32" x 3/4"	28	712	
GEOMAXSUL48S	Upholstered/Laminate Back Panel	43-3/16" x 36-17/32" x 3/4"	28	712	

Please specify Wood Finish (Table 1) or Laminate (Table 4). Details can be found on page GEN 4 and GEN 5.

	Catalog No.	Description	H x W x D	Wt. (lbs.)	Price
Mobile Arc Concave Single-Faced Shelving	<i>36"H Shelving</i>				
	GEOMAVSO36S	Oak Back Panel	31-3/16" x 45-27/32" x 1/4"	10.5	\$129
	GEOMAVSM36S	Maple Back Panel	31-3/16" x 45-27/32" x 1/4"	10.5	136
	GEOMAVSL36S	Laminate Back Panel	31-3/16" x 45-27/32" x 1/4"	10.5	96
	GEOMAVSWO36S	Whiteboard/Oak Back Panel	31-3/16" x 45-27/32" x 1/4"	14	294
	GEOMAVSWM36S	Whiteboard/Maple Back Panel	31-3/16" x 45-27/32" x 1/4"	14	294
	GEOMAVSWL36S	Whiteboard/Laminate Back Panel	31-3/16" x 45-27/32" x 1/4"	14	294
	GEOMAVSTO36S	Tackboard/Oak Back Panel	31-3/16" x 45-27/32" x 1/2"	19	315
	GEOMAVSTM36S	Tackboard/Maple Back Panel	31-3/16" x 45-27/32" x 1/2"	19	315
	GEOMAVSTL36S	Tackboard/Laminate Back Panel	31-3/16" x 45-27/32" x 1/2"	19	315
	GEOMAVSUO36S	Upholstered/Oak Back Panel	31-3/16" x 45-27/32" x 3/4"	20	588
	GEOMAVSUM36S	Upholstered/Maple Back Panel	31-3/16" x 45-27/32" x 3/4"	20	588
	GEOMAVSUL36S	Upholstered/Laminate Back Panel	31-3/16" x 45-27/32" x 3/4"	20	588
		<i>42"H Shelving</i>			
GEOMAVSO42S	Oak Back Panel	37-3/16" x 45-27/32" x 1/4"	13.5	\$139	
GEOMAVSM42S	Maple Back Panel	37-3/16" x 45-27/32" x 1/4"	13.5	147	
GEOMAVSL42S	Laminate Back Panel	37-3/16" x 45-27/32" x 1/4"	13.5	106	
GEOMAVSWO42S	Whiteboard/Oak Back Panel	37-3/16" x 45-27/32" x 1/4"	17.5	346	
GEOMAVSWM42S	Whiteboard/Maple Back Panel	37-3/16" x 45-27/32" x 1/4"	17.5	346	
GEOMAVSWL42S	Whiteboard/Laminate Back Panel	37-3/16" x 45-27/32" x 1/4"	17.5	346	
GEOMAVSTO42S	Tackboard/Oak Back Panel	37-3/16" x 45-27/32" x 1/2"	23	370	
GEOMAVSTM42S	Tackboard/Maple Back Panel	37-3/16" x 45-27/32" x 1/2"	23	370	
GEOMAVSTL42S	Tackboard/Laminate Back Panel	37-3/16" x 45-27/32" x 1/2"	23	370	
GEOMAVSUO42S	Upholstered/Oak Back Panel	37-3/16" x 45-27/32" x 3/4"	25	692	
GEOMAVSUM42S	Upholstered/Maple Back Panel	37-3/16" x 45-27/32" x 3/4"	25	692	
GEOMAVSUL42S	Upholstered/Laminate Back Panel	37-3/16" x 45-27/32" x 3/4"	25	692	
	<i>48"H Shelving</i>				
GEOMAVSO48S	Oak Back Panel	43-3/16" x 45-27/32" x 1/4"	16.5	\$152	
GEOMAVSM48S	Maple Back Panel	43-3/16" x 45-27/32" x 1/4"	16.5	159	
GEOMAVSL48S	Laminate Back Panel	43-3/16" x 45-27/32" x 1/4"	16.5	115	
GEOMAVSWO48S	Whiteboard/Oak Back Panel	43-3/16" x 45-27/32" x 1/4"	21	376	
GEOMAVSWM48S	Whiteboard/Maple Back Panel	43-3/16" x 45-27/32" x 1/4"	21	376	
GEOMAVSWL48S	Whiteboard/Laminate Back Panel	43-3/16" x 45-27/32" x 1/4"	21	376	
GEOMAVSTO48S	Tackboard/Oak Back Panel	43-3/16" x 45-27/32" x 1/2"	27	402	
GEOMAVSTM48S	Tackboard/Maple Back Panel	43-3/16" x 45-27/32" x 1/2"	27	402	
GEOMAVSTL48S	Tackboard/Laminate Back Panel	43-3/16" x 45-27/32" x 1/2"	27	402	
GEOMAVSUO48S	Upholstered/Oak Back Panel	43-3/16" x 45-27/32" x 3/4"	30	752	
GEOMAVSUM48S	Upholstered/Maple Back Panel	43-3/16" x 45-27/32" x 3/4"	30	752	
GEOMAVSUL48S	Upholstered/Laminate Back Panel	43-3/16" x 45-27/32" x 3/4"	30	752	

Please specify Wood Finish (Table 1) or Laminate (Table 4). Details can be found on page GEN 4 and GEN 5.

General Specifications for all Seating

SEAT FRAME

Seat frame will be 3/4" thick engineered hardwood. Frame components and corner blocks are glued and stapled. Foam for vertical surfaces will be 1/2" thick, 1.5 density, 45 CFR. Seat foam will be 2" thick, 2.5 density, #55 Ultra-cell.

BASE (TOE KICK)

Linear wood seating bases will be 3/4" thick hardwood. Curved seating bases will be 3/4" thick engineered plywood. Linear laminated seating bases will be 3/4" thick thermally-fused laminate panels. Curved seating bases will be 3/4" plywood laminated with high-pressure laminate.

Catalog No.	Seat H x W x D	Wt. (lbs.)	COM Price	Grade 1 Price	Grade 2 Price	Grade 3 Price	Grade 4 Price	Grade 5 Price
<u>Trapezoid Seat 1, 1 Unit with Oak Toe Kick</u>								
GEOLTSEAT1OAKS	17" x 35-29/32" x 24"	36	---	\$2,085	---	---	---	---
<u>Trapezoid Seat 1, 1 Unit with Maple Toe Kick</u>								
GEOLTSEAT1MAPS	17" x 35-29/32" x 24"	36	---	\$2,085	---	---	---	---
<u>Trapezoid Seat 1, 1 Unit with Laminate Toe Kick</u>								
GEOLTSEAT1LAMs	17" x 35-29/32" x 24"	36	---	\$2,034	---	---	---	---

Linear Trapezoid
1 Unit Seating





<u>Trapezoid Seat 2, 2 Units with Oak Toe Kick</u>								
GEOLTSEAT2OAKS	17" x 71-13/16" x 24"	60	---	\$2,978	---	---	---	---
<u>Trapezoid Seat 2, 2 Units with Maple Toe Kick</u>								
GEOLTSEAT2MAPS	17" x 71-13/16" x 24"	60	---	\$2,978	---	---	---	---
<u>Trapezoid Seat 2, 2 Units with Laminate Toe Kick</u>								
GEOLTSEAT2LAMs	17" x 71-13/16" x 24"	60	---	\$2,906	---	---	---	---

Linear Trapezoid
2 Unit Seating





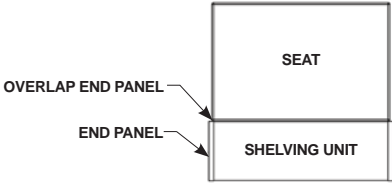

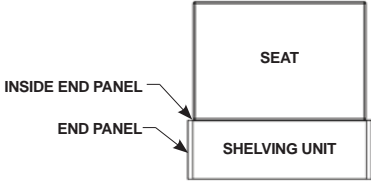
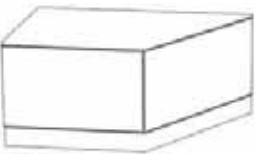
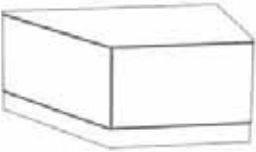
Please specify Wood Finish (Table 1) and Upholstery (Table 5). Details can be found on pages GEN 4 and GEN 5.

Note: Please call your customer service representative for Grade 2 through Grade 5 and COM pricing.

Catalog No.	Seat H x W x D	Wt. (lbs.)	COM Price	Grade 1 Price	Grade 2 Price	Grade 3 Price	Grade 4 Price	Grade 5 Price
Linear Rectangle 1 Unit Seating, Type 1 (Overlap End Panels)								
								
<i>Rectangle Seat 1, 1 Units with Oak Toe Kick</i>								
GEOLRSEAT1OAKS	17" x 36-1/4" x 24"	32	---	\$1,886	---	---	---	---
<i>Rectangle Seat 1, 1 Units with Maple Toe Kick</i>								
GEOLRSEAT1MAPS	17" x 36-1/4" x 24"	32	---	\$1,886	---	---	---	---
<i>Rectangle Seat 1, 1 Units with Laminate Toe Kick</i>								
GEOLRSEAT1LAMs	17" x 36-1/4" x 24"	32	---	\$1,840	---	---	---	---
								
Linear Rectangle 1 Unit Seating, Type 2 (Inside End Panels)								
								
<i>Rectangle Seat 2, 1 Units with Oak Toe Kick</i>								
GEOLRSEAT2OAKS	17" x 35-1/4" x 24"	32	---	\$1,886	---	---	---	---
<i>Rectangle Seat 2, 1 Units with Maple Toe Kick</i>								
GEOLRSEAT2MAPS	17" x 35-1/4" x 24"	32	---	\$1,886	---	---	---	---
<i>Rectangle Seat 2, 1 Units with Laminate Toe Kick</i>								
GEOLRSEAT2LAMs	17" x 35-1/4" x 24"	32	---	\$1,840	---	---	---	---
								
Linear Left Angled Seating								
								
<i>Left Angled Seat with Oak Toe Kick</i>								
GEOLSEATLOAKS	17" x 36-1/4" x 24"	30	---	\$1,985	---	---	---	---
<i>Left Angled Seat with Maple Toe Kick</i>								
GEOLSEATLMAPS	17" x 36-1/4" x 24"	30	---	\$1,985	---	---	---	---
<i>Left Angled Seat with Laminate Toe Kick</i>								
GEOLSEATLLAMs	17" x 36-1/4" x 24"	30	---	\$1,937	---	---	---	---
Linear Right Angled Seating								
								
<i>Right Angled Seat with Oak Toe Kick</i>								
GEOLSEATROAKS	17" x 36-1/4" x 24"	30	---	\$1,985	---	---	---	---
<i>Right Angled Seat with Maple Toe Kick</i>								
GEOLSEATRMAPS	17" x 36-1/4" x 24"	30	---	\$1,985	---	---	---	---
<i>Right Angled Seat with Laminate Toe Kick</i>								
GEOLSEATRLAMs	17" x 36-1/4" x 24"	30	---	\$1,937	---	---	---	---

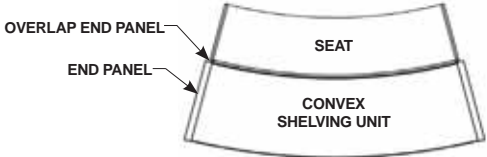
Please specify Wood Finish (Table 1) and Upholstery (Table 5). Details can be found on pages GEN 4 and GEN 5.

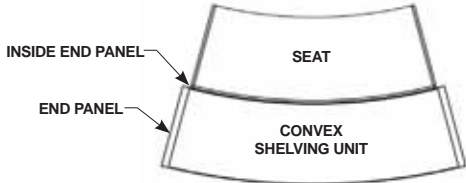
Note: Please call your customer service representative for Grade 2 through Grade 5 and COM pricing.

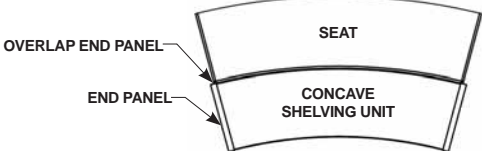
Catalog No.	Seat H x W x D	Wt. (lbs.)	COM Price	Grade 1 Price	Grade 2 Price	Grade 3 Price	Grade 4 Price	Grade 5 Price	
Arc Inner Seat Type 1 with Oak Toe Kick									
GEOAISEAT1OAKS	17-1/4" x 36-3/4" x 24"	32	---	\$1,922	---	---	---	---	Arc Inner Type 1 Seating (Overlap End Panels)
Arc Inner Seat Type 1 with Maple Toe Kick									
GEOAISEAT1MAPS	17-1/4" x 36-3/4" x 24"	32	---	\$1,922	---	---	---	---	
Arc Inner Seat Type 1 with Laminate Toe Kick									
GEOAISEAT1LAMS	17-1/4" x 36-3/4" x 24"	32	---	\$1,844	---	---	---	---	
Arc Inner Seat Type 2 with Oak Toe Kick									
GEOAISEAT2OAKS	17-1/4" x 35-3/4" x 24"	32	---	\$1,922	---	---	---	---	Arc Inner Type 2 Seating (Inside End Panels)
Arc Inner Seat Type 2 with Maple Toe Kick									
GEOAISEAT2MAPS	17-1/4" x 35-3/4" x 24"	32	---	\$1,922	---	---	---	---	
Arc Inner Seat Type 2 with Laminate Toe Kick									
GEOAISEAT2LAMS	17-1/4" x 35-3/4" x 24"	32	---	\$1,844	---	---	---	---	
Arc Outer Seat Type 1 with Oak Toe Kick									
GEOAOSEAT1OAKS	17-1/4" x 55-7/16" x 24"	48	---	\$2,361	---	---	---	---	Arc Outer Type 1 Seating (Overlap End Panels)
Arc Outer Seat Type 1 with Maple Toe Kick									
GEOAOSEAT1MAPS	17-1/4" x 55-7/16" x 24"	48	---	\$2,256	---	---	---	---	
Arc Outer Seat Type 1 with Laminate Toe Kick									
GEOAOSEAT1LAMS	17-1/4" x 55-7/16" x 24"	48	---	\$2,152	---	---	---	---	

Note: Arc Outer Type 1 Seating is used with 44"W Concave Single-Faced Inline Adders Type 1.

Please specify Wood Finish (Table 1) and Upholstery (Table 5). Details can be found on pages GEN 4 and GEN 5.

Note: Please call your customer service representative for Grade 2 through Grade 5 and COM pricing.

Catalog No.	Seat H x W x D	Wt. (lbs.)	COM Price	Grade 1 Price	Grade 2 Price	Grade 3 Price	Grade 4 Price	Grade 5 Price	
Arc Outer Type 2 Seating (Overlap End Panels)									
<u>Arc Outer Seat Type 2 with Oak Toe Kick</u>									
GEOAOSEAT2OAKS	17-1/4" x 49-5/8" x 24"	45	---	\$2,135	---	---	---	---	
<u>Arc Outer Seat Type 2 with Maple Toe Kick</u>									
GEOAOSEAT2MAPS	17-1/4" x 49-5/8" x 24"	45	---	\$2,135	---	---	---	---	
<u>Arc Outer Seat Type 2 with Laminate Toe Kick</u>									
GEOAOSEAT2LAMS	17-1/4" x 49-5/8" x 24"	45	---	\$2,048	---	---	---	---	

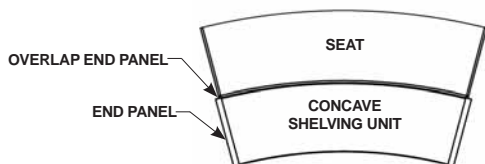

Note: Arc Outer Type 2 Seating is used with 37"W Concave Single-Faced Inline Adders Type 2.

Arc Outer Type 3 Seating (Inside End Panels)									
<u>Arc Outer Seat Type 3 with Oak Toe Kick</u>									
GEOAOSEAT3OAKS	17-1/4" x 48-5/8" x 24"	45	---	\$2,135	---	---	---	---	
<u>Arc Outer Seat Type 3 with Maple Toe Kick</u>									
GEOAOSEAT3MAPS	17-1/4" x 48-5/8" x 24"	45	---	\$2,135	---	---	---	---	
<u>Arc Outer Seat Type 3 with Laminate Toe Kick</u>									
GEOAOSEAT3LAMS	17-1/4" x 48-5/8" x 24"	45	---	\$2,048	---	---	---	---	

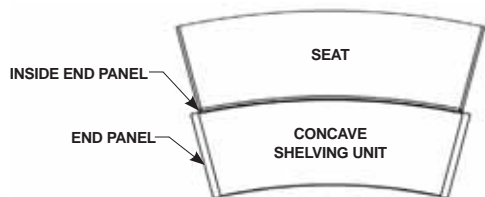
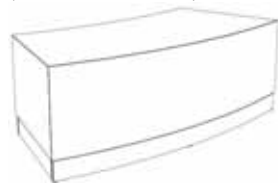

Note: Arc Outer Type 3 Seating is used with 37"W Concave Single-Faced Inline Adders Type 2.

Arc Outer Type 4 Seating (Inside End Panels)									
<u>Arc Outer Seat Type 4 with Oak Toe Kick</u>									
GEOAOSEAT4OAKS	17-1/4" x 54-7/16" x 24"	45	---	\$2,361	---	---	---	---	
<u>Arc Outer Seat Type 4 with Maple Toe Kick</u>									
GEOAOSEAT4MAPS	17-1/4" x 54-7/16" x 24"	45	---	\$2,256	---	---	---	---	
<u>Arc Outer Seat Type 4 with Laminate Toe Kick</u>									
GEOAOSEAT4LAMS	17-1/4" x 54-7/16" x 24"	45	---	\$2,152	---	---	---	---	

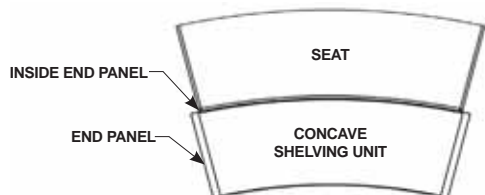
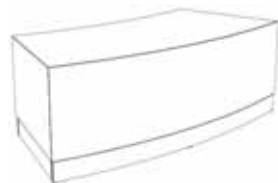

Note: Arc Outer Type 4 Seating is used with 44"W Concave Single-Faced Inline Adders Type 2.

Please specify Wood Finish (Table 1) and Upholstery (Table 5). Details can be found on pages GEN 4 and GEN 5.

Note: Please call your customer service representative for Grade 2 through Grade 5 and COM pricing.

General Specifications

TABLETOP FOR WOOD VENEER

Tabletop will be 1" thick veneer particleboard. Wood veneer tops receive a 1/4" thick x 1"W wood (Maple or Oak) edgeband.

TABLETOP FOR THERMALLY-FUSED LAMINATE (TFL)

Tabletop will be 1" thick MDF, with .050" thick thermally-fused laminate surface and .020" thick backing sheet for balanced construction. TFL tops receive a T-mold edgeband, which will be flexible polyethylene, 2mm thick x 1"W.

TABLETOP FOR HIGH-PRESSURE LAMINATE (HPL)

Tabletop will be 1" thick particle board, with .050" thick high-pressure laminate surface and .020" thick backing sheet for balanced construction. HPL tops receive a T-mold edgeband, which will be flexible polyethylene, 2mm thick x 1"W. Tabletops can also receive a 5/8" thick x 1-1/16"W wood (Maple or Oak) edgeband.

BLADE LEGS (METAL)

Legs will be 1" x 3" steel rectangular tubing with a wall thickness no less than 2mm. Legs are supplied with a standard glide insert. Metal legs attach to table top by means of a flange welded to the leg. Attachment flange will be 3-3/4" x 3-3/4" metal plate formed and welded on two sides to the leg. Each leg attachment flange is attached to the metal apron support frame using four #8 x 3/4" screws and then attached to the underneath of the tabletop by five #12 x 3/4" screws. Legs will be finished with electrostatic applied epoxy powder-coat paint.

APRON SUPPORT FRAME

A metal frame 1"W x 2"H x 2mm thick in various lengths will be attached to underside of the tabletop using #12 x 3/4" screws. Each leg attachment flange will be attached to the apron support frame using four #8 x 3/4" screws.

ASSEMBLED TABLES

Finished tables come in heights of 30"H, 36"H, and 42"H.

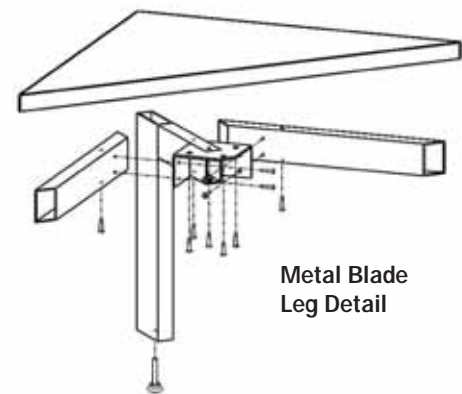

Catalog No.	Seat H x W x D	Wt. (lbs.)	COM Price	Grade 1 Price	Grade 2 Price	Grade 3 Price	Grade 4 Price	Grade 5 Price
<u>Table with Oak Veneer Top, Matching Wood Edgeband, Matching Toe Kick, and Upholstered Base</u>								
GEOTABUVO26S	26" x 26-3/16" x 31-3/4"	42	---	\$1,945	---	---	---	---
<u>Table with Maple Veneer Top, Matching Wood Edgeband, Matching Toe Kick, and Upholstered Base</u>								
GEOTABUVM26S	26" x 26-3/16" x 31-3/4"	42	---	\$1,945	---	---	---	---
<u>Table with TFL Top, T-Mold Edgeband, Matching Toe Kick, and Upholstered Base</u>								
GEOTABUTT26S	26" x 26-3/16" x 31-3/4"	42	---	\$1,559	---	---	---	---
<u>Table with HPL Top, Oak Edgeband, Matching Toe Kick, and Upholstered Base</u>								
GEOTABUHO26S	26" x 26-3/16" x 31-3/4"	42	---	\$1,842	---	---	---	---
<u>Table with HPL Top, Maple Edgeband, Matching Toe Kick, and Upholstered Base</u>								
GEOTABUHM26S	26" x 26-3/16" x 31-3/4"	42	---	\$1,842	---	---	---	---
<u>Table with HPL Top, T-Mold Edgeband, Matching Toe Kick, and Upholstered Base</u>								
GEOTABUHT26S	26" x 26-3/16" x 31-3/4"	42	---	\$1,693	---	---	---	---



Please specify Wood Finish (Table 1) and Upholstery (Table 5). Details can be found on pages GEN 4 and GEN 5.

Note: Please call your customer service representative for Grade 2 through Grade 5 and COM pricing.

	Catalog No.	Description	H x W x D	Wt. (lbs.)	Price
	Arc Table				
	Arc Table with Veneer Top and Matching Wood Edgeband				
	GEOTABVO3036S	Veneer Oak Top/Edgeband	30" x 35-1/2" x 60"	104	\$1,917
	GEOTABVM3036S	Veneer Maple Top/Edgeband	30" x 35-1/2" x 60"	104	2,046
	GEOTABVO3042S	Veneer Oak Top/Edgeband	30" x 41-3/4" x 60"	110	2,030
	GEOTABVM3042S	Veneer Maple Top/Edgeband	30" x 41-3/4" x 60"	110	2,168
	GEOTABVO3636S	Veneer Oak Top/Edgeband	36" x 35-1/2" x 60"	115	\$1,917
	GEOTABVM3636S	Veneer Maple Top/Edgeband	36" x 35-1/2" x 60"	115	2,046
	GEOTABVO3642S	Veneer Oak Top/Edgeband	36" x 41-3/4" x 60"	120	2,030
	GEOTABVM3642S	Veneer Maple Top/Edgeband	36" x 41-3/4" x 60"	120	2,168
	GEOTABVO4236S	Veneer Oak Top/Edgeband	42" x 35-1/2" x 60"	120	\$1,917
	GEOTABVM4236S	Veneer Maple Top/Edgeband	42" x 35-1/2" x 60"	120	2,046
GEOTABVO4242S	Veneer Oak Top/Edgeband	42" x 41-3/4" x 60"	125	2,030	
GEOTABVM4242S	Veneer Maple Top/Edgeband	42" x 41-3/4" x 60"	125	2,168	
Arc Table with TFL Top and T-Mold Edgeband					
GEOTABTT3036S	TFL Top, T-Mold Edgeband	30" x 35-1/2" x 60"	104	\$1,498	
GEOTABTT3042S	TFL Top, T-Mold Edgeband	30" x 41-3/4" x 60"	110	1,584	
GEOTABTT3636S	TFL Top, T-Mold Edgeband	36" x 35-1/2" x 60"	115	\$1,498	
GEOTABTT3642S	TFL Top, T-Mold Edgeband	36" x 41-3/4" x 60"	120	1,584	
GEOTABTT4236S	TFL Top, T-Mold Edgeband	42" x 35-1/2" x 60"	120	\$1,498	
GEOTABTT4242S	TFL Top, T-Mold Edgeband	42" x 41-3/4" x 60"	125	1,584	
Arc Table with HPL Top and Maple or Oak Edgeband					
GEOTABHO3036S	HPL Top, Oak Edgeband	30" x 35-1/2" x 60"	104	2,067	
GEOTABHM3036S	HPL Top, Maple Edgeband	30" x 35-1/2" x 60"	104	\$2,067	
GEOTABHO3042S	HPL Top, Oak Edgeband	30" x 41-3/4" x 60"	110	2,180	
GEOTABHM3042S	HPL Top, Maple Edgeband	30" x 41-3/4" x 60"	110	2,180	
GEOTABHO3636S	HPL Top, Oak Edgeband	36" x 35-1/2" x 60"	115	2,067	
GEOTABHM3636S	HPL Top, Maple Edgeband	36" x 35-1/2" x 60"	115	\$2,067	
GEOTABHO3642S	HPL Top, Oak Edgeband	36" x 41-3/4" x 60"	120	2,180	
GEOTABHM3642S	HPL Top, Maple Edgeband	36" x 41-3/4" x 60"	120	2,180	
GEOTABHO4236S	HPL Top, Oak Edgeband	42" x 35-1/2" x 60"	120	2,067	
GEOTABHM4236S	HPL Top, Maple Edgeband	42" x 35-1/2" x 60"	120	\$2,067	
GEOTABHO4242S	HPL Top, Oak Edgeband	42" x 41-3/4" x 60"	125	2,180	
GEOTABHM4242S	HPL Top, Maple Edgeband	42" x 41-3/4" x 60"	125	2,180	
Arc Table with HPL Top and T-Mold Edgeband					
GEOTABHT3036S	HPL Top, T-Mold Edgeband	30" x 35-1/2" x 60"	104	\$1,632	
GEOTABHT3042S	HPL Top, T-Mold Edgeband	30" x 41-3/4" x 60"	110	1,727	
GEOTABHT3636S	HPL Top, T-Mold Edgeband	36" x 35-1/2" x 60"	115	\$1,632	
GEOTABHT3642S	HPL Top, T-Mold Edgeband	36" x 41-3/4" x 60"	120	1,727	
GEOTABHT4236S	HPL Top, T-Mold Edgeband	42" x 35-1/2" x 60"	120	\$1,632	
GEOTABHT4242S	HPL Top, T-Mold Edgeband	42" x 41-3/4" x 60"	125	1,727	

Please specify Wood Finish (Table 1), Laminate Color (Tables 2 and 4), Edgeband Color (Table 4), and Metal Leg Color (Table 3).

Details can be found on page GEN 4 and GEN 5

Note: Edgeband Color does NOT have to match Laminate Color

The Horizons Collection



2017 Price List and Specifications

Brodart Co. Contract Furniture - Made in USA

280 North Road, Clinton County Industrial Park • McElhattan, PA 17748

Toll-Free: 888-521-1884 • E-Mail: furniture@brodart.com • www.brodartfurniture.com

General Specifications

DESKTOP

Standard desktops are 1-3/16" thick, 3-ply, 45# density, particleboard core, with a top surface of .050" thick, high-pressure laminate, with a backing sheet not less than .020" thickness for balanced construction. High-pressure laminate has a lo-glare finish resistant to scratches, fading, and staining that meets or exceeds NEMA standards. Top receives a 5/8" thick x 1-3/16" solid maple edge band on the patron side with edges radiused to form a bullnose shape. A 1/4" thick, solid maple edge band is applied to the remaining three sides, with top and bottom edges radiused to 1/8". All edges are applied to the desktop after the top and bottom laminate sheets are applied, constituting an external edge band. Desktop is positioned over the end panels of the desk module, flush with the outside edges of the end panels.

END PANEL

Desk module end panels are 1" thick, 3-ply, 45# density particleboard core with select plain-sliced maple veneer on both sides. Exposed edges are externally banded with a maple band. The end panels and front panel are joined and secured with 3/4" x 3/4" thick solid hardwood cleats screwed to the inside surfaces of the panels. The bottom of each end panel receives two adjustable glides to allow leveling of the individual units. Each end panel receives a 3" diameter egress and grommet to provide for wire passage.

FRONT PANEL

The front panel is 3/4" thick, comprised of select plain-sliced face veneers maple over a 45# density particle board core. Exposed edges are externally banded with a maple band. The front incorporates a 6"H x 3/4"D recessed, ebonized, toe space at the bottom of the panel. The front panel is positioned over the end panels of the desk module, flush with the outside edges of the end panels. Double wide units have two front panels to give the appearance of two individual units. At the top of the front panel, a 6"W x 1/4" thick maple plywood accent panel is attached that runs the full width of the desk unit front. The grain direction runs horizontally. This panel has a large cutout design as selected by the customer. The inside edges of the cutout and outer edges of the accent panel are blackened to provide a finished appearance. When the cutout design is large enough, a matching cutout of colored high-pressure laminate is inlaid in the cutout. When the cutout is small (such as the sports stick figures) no high-pressure laminate is inlaid.

DESK DIMENSIONS

Standing-Height Desk, overall:
39-3/16"H x 35"W x 30"D or 39-3/16"H x 70"W x 30"D.

Sitting-Height Desk, overall:
32-3/16"H x 35"W x 30"D or 32-3/16"H x 70"W x 30"D.

WORK SURFACE

Work surfaces are 1-3/16" thick, 3-ply particleboard core, including a top surface of .050" thick, high-pressure laminate with a backing sheet not less than .020" thickness for balanced construction. High-pressure laminate has a lo-glare finish resistant to scratches, fading, and staining that meets or exceeds NEMA standards. The exposed edge receives a 1/4" thick, solid maple internal edge band in straight design. The back edge of the work surface has a black plastic band 1-1/2"W which projects above the work surface 1/4" to act as a retainer. The work surface is 24-1/2"D and is positioned 1-1/2" away from the front panel, creating a cord drop space. Adjustable work surfaces are available in single wide standing height desks. Work surfaces in standing-height desks (catalog number 77-012) may be positioned at heights of 36", 32" or 27".

Note: See Brodart optional electrical accessories for electrical power distribution system for desk modules.

SHELVES

Shelves are constructed of 7-ply veneer-core plywood, with plain sliced maple face veneer. Exposed edges receive a maple edge band.

DRAWER

Drawers are constructed of solid hardwood with 1/4" thick wood bottom panel. Drawers have 3-ply particleboard fronts with select maple-face veneer. Box drawers have extension slides with 100# load capacity. File drawers have full-extension slides with 100# load capacity.

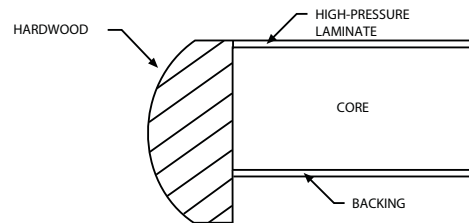



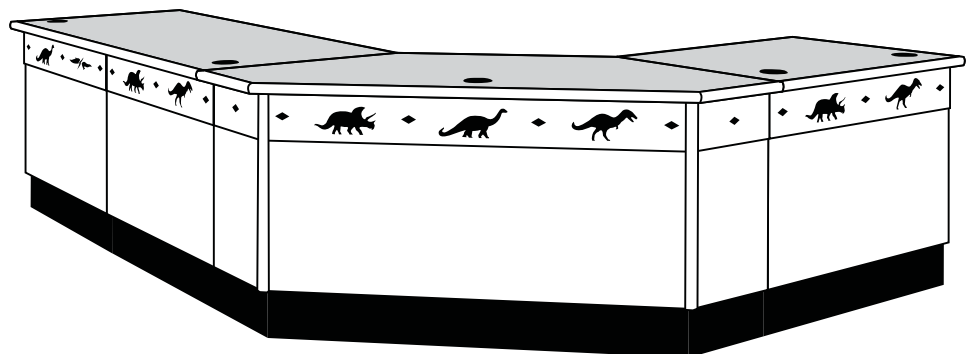

Horizons Flush Edge



Oak Catalog No.	Maple Catalog No.	Description	H x W x D	Wt. (lbs.)	Oak Price	Maple Price	Standing	Sitting
77-012-S00 OAK	77-012-S00 MAP	Standing Height Desk with Patron Service Ledge Inside dimensions: 33"W x 26-3/4"D. The 7-7/8" patron ledge is at a height of 39-3/16"H. Note: Adjustable-height work surface may be positioned at heights of 36", 32" or 27".	39-3/16" x 35" x 30"	140	\$3,322	\$3,621	Single-Wide Desk with Patron Service Ledge	
77-E12-S00 OAK	77-E12-S00 MAP	Sitting Height Desk with Patron Service Ledge Inside dimensions: 33"W x 26-3/4"D. The 7-7/8" patron ledge is at a height of 32-3/16"H. Note: Work surface is fixed at 27"H.	32-3/16" x 35" x 30"	125	\$3,184	\$3,471	Single-Wide Desk with Patron Service Ledge	
77-014-S00 OAK	77-014-S00 MAP	Standing Height Desk without Patron Service Ledge Inside dimensions: 33"W x 26-3/4"D. The work surface is at 39-3/16"H. Two 3" diameter grommets are located in the work surface.	39-3/16" x 35" x 30"	135	\$2,973	\$3,240	Single-Wide Desk without Patron Service Ledge	
77-E14-S00 OAK	77-E14-S00 MAP	Sitting Height Desk without Patron Service Ledge Inside dimensions: 33"W x 26-3/4"D. The work surface is at 32-3/16"H. Two 3" diameter grommets are located in the work surface.	32-3/16" x 35" x 30"	120	\$2,727	\$2,972	Single-Wide Desk without Patron Service Ledge	
77-015-S00 OAK	77-015-S00 MAP	Standing Height Book Return Unit Inside dimensions: 33"W x 26-3/4"D. The work surface is at 39-3/16"H. Unit has a 5"H x 12"W finished opening centered in the front panel for passage of books and a book chute to direct the books over a mobile depressible book truck. (Depressible book truck not included). Two 3" diameter grommets are located in the work surface.	39-3/16" x 35" x 30"	135	\$2,900	\$3,161	Book Return Unit	
77-E15-S00 OAK	77-E15-S00 MAP	Sitting Height Book Return Unit Inside dimensions: 33"W x 26-3/4"D. The work surface is at 32-3/16"H. Unit has a 5"H x 12"W finished opening centered in the front panel for passage of books and a book chute to direct the books over a mobile depressible book truck. (Depressible book truck not included). Two 3" diameter grommets are located in the work surface.	32-3/16" x 35" x 30"	120	\$2,763	\$3,012	Book Return Unit	



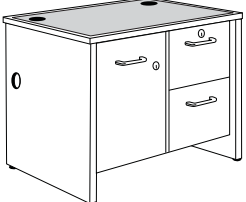

Please specify Wood Finish (Table 1) and High-Pressure Laminate (Table 2). Details can be found on page GEN 4.

Note: Specify Cutout Design. Details can be found on page HOR 32.

Standing	Sitting	Oak Catalog No.	Maple Catalog No.	Description	H x W x D	Wt. (lbs.)	Oak Price	Maple Price
		77-121-S00 OAK	77-121-S00 MAP	Standing Height Cupboard and Open Shelf	39-3/16" x 35" x 30"	175	\$5,137	\$5,519
				This unit has one fixed and two adjustable shelves. A hidden drawer is positioned above the lockable storage compartment. Two 3" diameter grommets are located in the work surface.				
		77-E21-S00 OAK	77-E21-S00 MAP	Sitting Height Cupboard	32-3/16" x 35" x 30"	160	\$4,841	\$5,276
				This unit has one fixed and one adjustable shelf. A hidden drawer is positioned above the lockable storage compartment. Two 3" diameter grommets are located in the work surface.				
		77-122-S00 OAK	77-122-S00 MAP	Standing Height Full Width Drawer, Cupboard and Drawers	39-3/16" x 35" x 30"	225	\$6,822	\$7,436
				This unit has one full-width drawer, two file drawers, and a lockable storage compartment. Two 3" diameter grommets are located in the work surface. Note: Available in 39"H only.				
		77-123-S00 OAK	77-123-S00 MAP	Standing Height Cupboard and Drawer Unit	39-3/16" x 35" x 30"	225	\$6,107	\$6,656
				This unit has one locking box drawer and two file drawers. Cupboard section has two adjustable shelves and locking door on hinges. Two 3" diameter grommets are located in the work surface.				
		77-E23-S00 OAK	77-E23-S00 MAP	Sitting Height Cupboard and Drawer Unit	32-3/16" x 35" x 30"	205	\$5,613	\$6,119
				This unit has one locking file drawer and one file drawer. Cupboard section has one adjustable shelf and locking door on hinges. Two 3" diameter grommets are located in the work surface.				

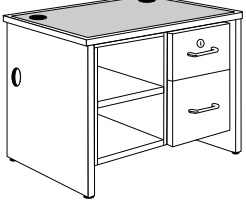
Please specify Wood Finish (Table 1) and High-Pressure Laminate (Table 2). Details can be found on page GEN 4.

Note: Specify Cutout Design. Details can be found on page HOR 32.

Oak Catalog No.	Maple Catalog No.	Description	H x W x D	Wt. (lbs.)	Oak Price	Maple Price	Standing	Sitting
77-124-S00 OAK	77-124-S00 MAP	<p>Standing Height Open Shelf and Drawer Unit</p> <p>This unit has one lockable box drawer and two file drawers. Shelf section has two adjustable shelves, and one fixed base shelf. Two 3" diameter grommets are located in the work surface.</p>	39-3/16" x 35" x 30"	200	\$5,684	\$6,196	Open Shelf and Drawer Unit	
								
77-E24-S00 OAK	77-E24-S00 MAP	<p>Sitting Height Open Shelf and Drawer Unit</p> <p>This unit has one lockable box drawer and one file drawer. Shelf section has one adjustable shelf, and one fixed base shelf. Two 3" diameter grommets are located in the work surface.</p>	32-3/16" x 35" x 30"	125	\$5,262	\$5,735		
								
77-131-S00 OAK	77-131-S00 MAP	<p>Standing Height Cash Drawer Unit</p> <p>Inside dimensions: 33"W x 26-3/4"D. The work surface is at 39-3/16"H. Desk has locking drawer with a coin and currency tray. Two 3" diameter grommets are located in the work surface.</p>	39-3/16" x 35" x 30"	150	\$4,047	\$4,412	Cash Drawer Unit	
								
77-E31-S00 OAK	77-E31-S00 MAP	<p>Sitting Height Cash Drawer Unit</p> <p>Inside dimensions: 33"W x 26-3/4"D. The work surface is at 32-3/16"H. Desk has locking drawer with a coin and currency tray. Two 3" diameter grommets are located in the work surface.</p>	32-3/16" x 35" x 30"	135	\$5,241	\$5,713		
								
77-E32-S00 OAK	77-E32-S00 MAP	<p>Sitting Height ADA Station</p> <p>The ADA transaction station is designed to provide wheelchair access on the patrons' side. The knee space depth on the patrons' side is 22-1/4" and on the staff side is 16". Two 3" diameter grommets are located in the work surface. One 3-1/2" diameter egress with sleeve is located in each end panel for wire passage.</p>	32-3/16" x 35" x 40-1/2"	185	\$2,727	\$2,972	ADA Station	
								







Please specify Wood Finish (Table 1) and High-Pressure Laminate (Table 2). Details can be found on page GEN 4.

Note: Specify Cutout Design. Details can be found on page HOR 32.

Standing	Sitting	Oak Catalog No.	Maple Catalog No.	Description	H x W x D	Wt. (lbs.)	Oak Price	Maple Price
		77-133-S00 OAK	77-133-S00 MAP	Standing Height Full Width Drawer Unit This drawer unit has a full-width drawer 10"H x 33"W x 18-3/4"D. Two 3" diameter grommets are located in the work surface. Note: Available in 39-3/16"H only.	39-3/16" x 35" x 30"	160	\$4,145	\$4,519
		77-135-S00 OAK	77-135-S00 MAP	Standing Height Full Width Drawer and Cupboard Unit This unit has a full-width drawer 10"H x 33"W x 18-3/4"D. Also, one fixed and one adjustable, full-depth shelf. Hinged doors have a catch, lock and door pulls. Two 3" diameter grommets are located in the work surface. Note: Available in 39-3/16"H only.	39-3/16" x 35" x 30"	220	\$4,544	\$4,953
		77-172-S00 OAK	77-172-S00 MAP	Standing Height Discharge Unit These units have a full-width well with seven removable wood trays for 5"H x 3"W cards. The 7-7/8" patron ledge is at a height of 39-3/16"H. Note: Standing-height roll unders do not work with this unit.	39-3/16" x 35" x 30"	165	\$4,307	\$4,694
		77-E72-S00 OAK	77-E72-S00 MAP	Sitting Height Discharge Unit These units have a full-width well with seven removable wood trays for 5"H x 3"W cards. The 7-7/8" patron ledge is at a height of 32-3/16"H.	32-3/16" x 35" x 30"	145	\$4,109	\$4,478

Please specify Wood Finish (Table 1) and High-Pressure Laminate (Table 2). Details can be found on page GEN 4.

Note: Specify Cutout Design. Details can be found on page HOR 32.

Oak Catalog No.	Maple Catalog No.	Description	H x W x D	Wt. (lbs.)	Oak Price	Maple Price	Standing	Sitting
77-174-S00 OAK	77-174-S00 MAP	Standing Height Open Shelf Unit This unit has a full-depth fixed base shelf and two full-depth adjustable shelves. Two 3" diameter grommets are located in the work surface.	39-3/16" x 35" x 30"	175	\$3,358	\$3,660		Open Shelf Unit
								
77-E74-S00 OAK	77-E74-S00 MAP	Sitting Height Open Shelf Unit This unit has a full-depth fixed base shelf and two full-depth adjustable shelves. Two 3" diameter grommets are located in the work surface.	32-3/16" x 35" x 30"	155	\$3,058	\$3,333		
								
77-176-S00 OAK	77-176-S00 MAP	Standing Height Cupboard Unit This unit has a full-depth fixed base shelf and two full-depth adjustable shelves. Hinged doors have a catch, lock and door pulls. Two 3" diameter grommets are located in the work surface.	39-3/16" x 35" x 30"	200	\$4,028	\$4,390		Cupboard Unit
								
77-E76-S00 OAK	77-E76-S00 MAP	Sitting Height Cupboard Unit This unit has a full-depth fixed base shelf and one full-depth adjustable shelf. Hinged doors have a catch, lock and door pulls. Two 3" diameter grommets are located in the work surface.	32-3/16" x 35" x 30"	180	\$3,870	\$4,218		
								
77-234-S00 OAK	77-234-S00 MAP	Standing Height Full Width Drawer and Open Shelves This unit has a full-width drawer 10"H x 33"W x 18-3/4"D. Also, one fixed and one adjustable, full-depth shelf. Two 3" diameter grommets are located in the work surface.	39-3/16" x 35" x 30"	180	\$3,951	\$4,307		Full Width Drawer and Open Shelves
								
77-E34-S00 OAK	77-E34-S00 MAP	Sitting Height Full Width Drawer and Open Shelves This unit has a full-width drawer 10"H x 33"W x 18-3/4"D. Also, one fixed and one adjustable, full-depth shelf. Two 3" diameter grommets are located in the work surface.	32-3/16" x 35" x 30"	165	\$3,753	\$4,091		
								

Please specify Wood Finish (Table 1) and High-Pressure Laminate (Table 2). Details can be found on page GEN 4.





Note: Specify Cutout Design. Details can be found on page HOR 32.

Standing	Sitting	Oak Catalog No.	Maple Catalog No.	Description	H x W x D	Wt. (lbs.)	Oak Price	Maple Price
		77-236-S00 OAK	77-236-S00 MAP	Standing Height Media Storage Unit This unit has four full-width drawers 8-1/2"H x 33"W x 24"D with each containing five compartments for media storage.	39-3/16" x 35" x 30"	225	\$5,103	\$5,562
		77-E36-S00 OAK	77-E36-S00 MAP	Sitting Height Media Storage Unit This unit has three full-width drawers 8-1/2"H x 33"W x 24"D with each containing five compartments for media storage.	32-3/16" x 35" x 30"	205	\$4,738	\$5,164



Please specify Wood Finish (Table 1) and High-Pressure Laminate (Table 2). Details can be found on page GEN 4.

Note: Specify Cutout Design. Details can be found on page HOR 32.

Oak Catalog No.	Maple Catalog No.	Description	H x W x D	Wt. (lbs.)	Oak Price	Maple Price	Standing	Sitting
77-011-S00 OAK	77-011-S00 MAP	Standing Height Double-Wide Desk with Patron Service Ledge Work Surface at 35"H Inside dimensions are 68"W x 26-3/4"D. The 7-7/8"D patron ledge is at a height of 39-3/16". Two 3" diameter grommets are located in the work surface. Note: Standing-height roll unders do not work with this unit.	39-3/16" x 70" x 30"	245	\$5,126	\$5,587		Double-Wide Desk with Patron Service Ledge,
								
77-E11-S00 OAK	77-E11-S00 MAP	Sitting Height Double-Wide Desk with Patron Service Ledge Work Surface at 28"H Inside dimensions are 68"W x 26-3/4"D. The 7-7/8"D patron ledge is at a height of 32-3/16". Two 3" diameter grommets are located in the work surface.	32-3/16" x 70" x 30"	210	\$4,902	\$5,343		
								
77-011-SEA OAK	77-011-SEA MAP	Standing Height Double-Wide Desk with Patron Service Ledge Work Surface at 28"H Inside dimensions are 68"W x 26-3/4"D. The 7-7/8"D patron ledge is at a height of 39-3/16". Two 3" diameter grommets are located in the work surface. Note: Standing-height roll unders do not work with this unit.	39-3/16" x 70" x 30"	245	\$5,139	\$5,601		
								
77-013-S00 OAK	77-013-S00 MAP	Standing Height Double-Wide Desk without Patron Service Ledge Inside dimensions are 68"W x 26-3/4"D. The work surface is at 39-3/16" H. Two 3" diameter grommets are located in the work surface.	39-3/16" x 70" x 30"	230	\$4,684	\$5,106		Double-Wide Desk without Patron Service Ledge
								
77-E13-S00 OAK	77-E13-S00 MAP	Sitting Height Double-Wide Desk without Patron Service Ledge Inside dimensions are 68"W x 26-3/4"D. The work surface is at 32-3/16" H. Two 3" diameter grommets are located in the work surface.	32-3/16" x 70" x 30"	195	\$4,509	\$4,915		
								

Please specify Wood Finish (Table 1) and High-Pressure Laminate (Table 2). Details can be found on page GEN 4.

Note: Specify Cutout Design. Details can be found on page HOR 32.

Standing	Sitting	Oak Catalog No.	Maple Catalog No.	Description	H x W x D	Wt. (lbs.)	Oak Price	Maple Price
Double-Wide	Double Pedestal	77-E37-S00 OAK	77-E37-S00 MAP	Sitting Height Double-Wide Double Pedestal Work Desk	32-3/16" x 70" x 30"	260	\$9,284	\$10,120



Inside dimensions are 68"W x 26-3/4"D.
 This unit has two drawer pedestals, one mounted on each side consisting of one locking drawer at top; one file drawer with hanging file rack at bottom. Two center drawers are mounted between the two pedestals. Two 3" diameter grommets are located in the work surface.
Note: Available in 32-3/16" H only.

Double-Wide	Single Pedestal	77-238-S00 OAK	77-238-S00 MAP	Standing Height Double-Wide Single Pedestal Work Desk	39-3/16" x 70" x 30"	230	\$6,512	\$7,098
-------------	-----------------	----------------	----------------	--	----------------------	-----	---------	---------



Inside dimensions are 68"W x 26-3/4"D.
 This unit has one drawer pedestal mounted on the left side consisting of one locking drawer at top; two file drawers with Pendaflex hangers at the bottom. Two 3" diameter grommets are located in the work surface.



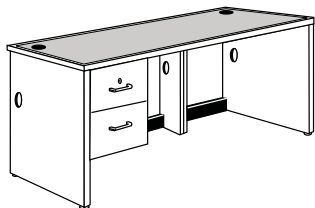



		77-E38-S00 OAK	77-E38-S00 MAP	Sitting Height Double-Wide Single Pedestal Work Desk	32-3/16" x 70" x 30"	195	\$6,218	\$6,778
--	--	----------------	----------------	---	----------------------	-----	---------	---------



Inside dimensions are 68"W x 26-3/4"D.
 This unit has one drawer pedestal mounted on the left side consisting of one locking file drawer at top; one file drawer at the bottom, both with hanging file racks. Two 3" diameter grommets are located in the work surface.







Please specify Wood Finish (Table 1) and High-Pressure Laminate (Table 2). Details can be found on page GEN 4.

Note: Specify Cutout Design. Details can be found on page HOR 32.

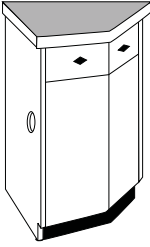
Oak Catalog No.	Maple Catalog No.	Description	H x W x D	Wt. (lbs.)	Oak Price	Maple Price	Standing	Sitting
77-010-S00 OAK	77-010-S00 MAP	Standing Height 90 Degree Multi-Purpose Corner Unit has 29-5/16" W port area. Storage shelves are located in the two angled areas to the left and right of the desk module. One 3" diameter grommet is located in the work-surface top. One 3-1/2" diameter egress with sleeve is located in each end panel for wire passage.	39-3/16" x 71-3/4" x 30"	250	\$8,050	\$8,775		90 Degree Multi-Purpose Corner
								
77-E10-S00 OAK	77-E10-S00 MAP	Sitting Height 90 Degree Multi-Purpose Corner Unit has 29-5/16" W port area. Storage shelves are located in the two angled areas to the left and right of the desk module. One 3" diameter grommet is located in the work-surface top. One 3-1/2" diameter egress with sleeve is located in each end panel for wire passage.	32-3/16" x 71-3/4" x 30"	215	\$7,706	\$8,401		
								
77-017-S00 OAK	77-017-S00 MAP	Standing Height 90 Degree Multi-Purpose with Patron Service Ledge Unit has 29-5/16" W port area. The 7-7/8" D patron ledge is at a height of 39-3/16". Work surface is at 35"H. Storage shelves are located in the two angled areas to the left and right of the module. One 3" diameter grommet is located in the work surface top. One 3-1/2" diameter egress with sleeve is located in each end panel for wire passage.	39-3/16" x 71-3/4" x 30"	245	\$10,364	\$11,296		90 Degree Multi-Purpose Corner with Patron Service Ledge
								
77-E17-S00 OAK	77-E17-S00 MAP	Sitting Height 90 Degree Multi-Purpose with Patron Service Ledge Unit has 29-5/16" W port area. The 7-7/8" D patron ledge is at a height of 32-3/16". Work surface is at 28"H. Storage shelves are located in the two angled areas to the left and right of the module. One 3" diameter grommet is located in the work surface top. One 3-1/2" diameter egress with sleeve is located in each end panel for wire passage.	32-3/16" x 71-3/4" x 30"	210	\$9,905	\$10,797		
								
77-016-S00 OAK	77-016-S00 MAP	Standing Height 90 Degree Closed Corner Unit This 90 degree unit is used to form a right angle turn in a desk arrangement. This is not available with patron ledge. One 3-1/2" diameter egress is located in each end panel for wire passage through a continuous ABS tube.	39-3/16" H	140	\$3,787	\$4,128		90 Degree Closed Corner Unit
								
77-E16-S00 OAK	77-E16-S00 MAP	Sitting Height 90 Degree Closed Corner Unit This 90 degree unit is used to form a right angle turn in a desk arrangement. This is not available with patron ledge. One 3-1/2" diameter egress is located in each end panel for wire passage through a continuous ABS tube.	32-3/16" H	120	\$3,627	\$3,953		
								

Please specify Wood Finish (Table 1) and High-Pressure Laminate (Table 2). Details can be found on page GEN 4.

Note: Specify Cutout Design. Details can be found on page HOR 32.

Standing	Sitting	Oak Catalog No.	Maple Catalog No.	Description	H x W x D	Wt. (lbs.)	Oak Price	Maple Price
				45 Degree Curved Closed Corner Unit				
		77-018-S00 OAK	77-018-S00 MAP	Standing Height 45 Degree Curved Closed Corner Unit This unit is used to create a 45 degree angle in the circulation desk. It is not available with patron ledge.	39-3/16" x 22-3/8" x 30"	130	\$3,787	\$4,128
				45 Degree Curved Closed Corner Unit				
		77-E18-S00 OAK	77-E18-S00 MAP	Sitting Height 45 Degree Curved Closed Corner Unit This unit is used to create a 45 degree angle in the circulation desk. It is not available with patron ledge.	32-3/16" x 22-3/8" x 30"	110	\$3,627	\$3,953
				90 Degree Open Corner Shelf				
		77-143-S00 OAK	77-143-S00 MAP	Standing Height 90 Degree Open Corner Shelf This 90 degree unit is used to form a right-angle turn in a desk arrangement. Has one fixed base shelf and two adjustable shelves. Note: Units must be modified on a project by project basis for electrical pass-through on open corner units.	39-3/16"H x 30"D	140	\$3,495	\$3,810
		77-E43-S00 OAK	77-E43-S00 MAP	Sitting Height 90 Degree Open Corner Shelf This 90 degree unit is used to form a right-angle turn in a desk arrangement. Has one fixed base shelf and two adjustable shelves. Note: Units must be modified on a project by project basis for electrical pass-through on open corner units.	32-3/16"H x 30"D	120	\$3,345	\$3,647
				90 Degree Square Corner Unit				
		77-150-S00 OAK	77-150-S00 MAP	Standing Height 90 Degree Square Corner Unit This square corner unit is used to form a right angle in a desk arrangement. One 3" diameter egress is located in each end panel for wire passage through a continuous ABS tube.	39-3/16" x 30" x 30"	160	\$4,157	\$4,531
		77-E50-S00 OAK	77-E50-S00 MAP	Sitting Height 90 Degree Square Corner Unit This square corner unit is used to form a right angle in a desk arrangement. One 3" diameter egress is located in each end panel for wire passage through a continuous ABS tube.	32-3/16" x 30" x 30"	140	\$3,813	\$4,157

Please specify Wood Finish (Table 1) and High-Pressure Laminate (Table 2). Details can be found on page GEN 4.

Note: Specify Cutout Design. Details can be found on page HOR 32.

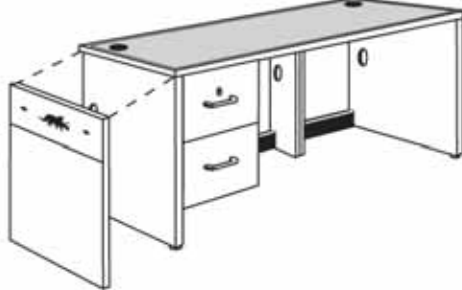
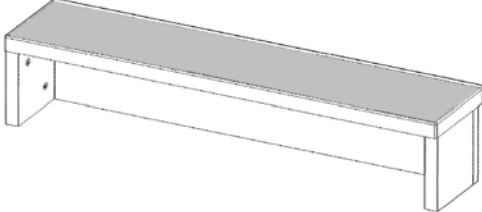
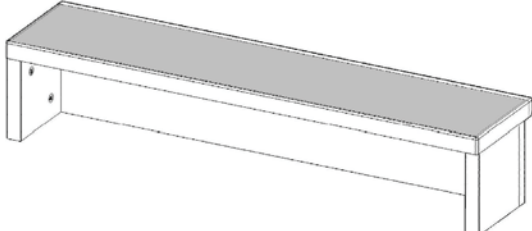
Oak Catalog No.	Maple Catalog No.	Description	H x W x D	Wt. (lbs.)	Oak Price	Maple Price	
77-178-S00 OAK	77-178-S00 MAP	Detachable End Panels (Pair) End panels are 1" thick, 3-ply, 45# density particleboard core with plain-sliced oak or maple veneers. Exposed edges are externally banded with 1.6mm thick, solid Northern-grown Oak or maple edge band.	37-1/2" x 1" x 26-3/4"	52	\$2,226	\$2,426	Detachable End Panels (Pair) 
77-E78-S00 OAK	77-E78-S00 MAP	Detachable End Panels (Pair) End panels are 1" thick, 3-ply, 45# density particleboard core with plain-sliced oak or maple veneers. Exposed edges are externally banded with 1.6mm thick, solid Northern-grown Oak or maple edge band.	30-1/2" x 1" x 26-3/4"	42	\$2,178	\$2,374	
77-196-S00 OAK	77-196-S00 MAP	Single-Wide Add On 7"H Patron Ledge Unit is designed to be added onto a single wide desk without a patron ledge. The Patron Ledge Assembly will attach to the desktop by means of #8 x 2-1/2" screws inserted through the work surface into the ledge assembly.	7" x 35" x 7-7/8"	10	\$526	\$574	Single-Wide Add On 7"H Patron Ledge 
77-197-S00 OAK	77-197-S00 MAP	Double-Wide Add On 7"H Patron Ledge Unit is designed to be added onto a double wide desk without a patron ledge. The Patron Ledge Assembly will attach to the desktop by means of #8 x 2-1/2" screws inserted through the work surface into the ledge assembly.	7" x 70" x 7-7/8"	20	\$665	\$725	Double-Wide Add On 7"H Patron Ledge 

Please specify Wood Finish (Table 1) and High-Pressure Laminate (Table 2). Details can be found on page GEN 4.

Note: Specify Cutout Design. Details can be found on page HOR 32.

General Specifications

TABLETOPS

Standard tabletops are 1-3/16" thick, 9-ply plywood core, or a 1-3/16" thick particleboard core, including a top surface of .050" thick, high-pressure laminate, with a backing sheet not less than .020" thickness for balanced construction. High-pressure laminate has a lo-glare finish resistant to scratches, fading, and staining that meets or exceeds NEMA standards. Edges are solid maple. Drop edge band is 5/8" thick x 1-5/8" externally banded to form a bullnose.

TABLE LEGS

Legs are solid maple wood, 2-1/2" diameter. Each leg has a 3-1/2" diameter x 2-5/8"H glued-up maple bun-foot. Each bun-foot has a 2" diameter, adjustable glide mounted in a recessed tee-nut. The glide is further recessed into the bun-foot by means of a counter-sunk boring which accepts the upper two-thirds of the glide.

Legs attach to tabletops by means of a 5" square x 5/16" thick steel plate. The plate is attached to the leg by a 5/16" x 2-1/2" machine bolt engaging a 5/8" diameter barrel nut inserted into the leg. The steel plate is attached to the tabletop by five 5/16" x 1" machine bolts engaging internally and externally threaded bushings in the underside of the tabletop. Leg plates are positioned behind, and be hidden by, the extended table edge band.

TABLETOP SUPPORT

For maximum rigidity, rectangular tables, 60" or more wide, receive a V-shaped, 14-gauge steel keel securely fastened to the underside of the tabletop. Tables 48"D and more than 60" W, receive two steel keels parallel to the length of the table. Tables 90" or wider receive two extra matching legs located under the center of the table to provide added support.

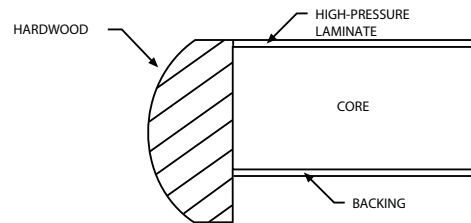

Horizons Drop Edge

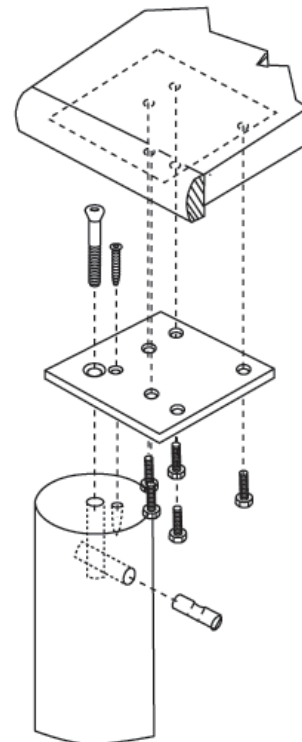

Horizons Wood Leg

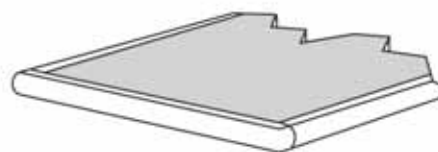

Horizons External Edge Band

Plywood Core Catalog No.	Particleboard Core Catalog No.	Description	H x W x D	Wt. (lbs.)	Plywood Core Price	Particleboard Core Price
Round Oak Table						
77-109-S00 OAK	77-109-S02 OAK	Adult Table	29"H x 36" Diameter	100	\$2,051	\$1,966
77-Y09-S00 OAK	77-Y09-S02 OAK	Youth Table	27-1/2"H x 36" Diameter	100	\$2,051	\$1,966
77-J09-S00 OAK	77-J09-S02 OAK	Juvenile Table	25"H x 36" Diameter	100	\$2,051	\$1,966
77-129-S00 OAK	77-129-S02 OAK	Adult Table	29"H x 42" Diameter	110	\$2,173	\$2,087
77-Y29-S00 OAK	77-Y29-S02 OAK	Youth Table	27-1/2"H x 42" Diameter	110	\$2,173	\$2,087
77-J29-S00 OAK	77-J29-S02 OAK	Juvenile Table	25"H x 42" Diameter	110	\$2,173	\$2,087
77-141-S00 OAK	77-141-S02 OAK	Adult Table	29"H x 48" Diameter	120	\$2,173	\$2,087
77-Y41-S00 OAK	77-Y41-S02 OAK	Youth Table	27-1/2"H x 48" Diameter	120	\$2,173	\$2,087
77-J41-S00 OAK	77-J41-S02 OAK	Juvenile Table	25"H x 48" Diameter	120	\$2,173	\$2,087
N/A	77-130-S02 OAK	Adult Table	29"H x 60" Diameter	140	N/A	\$2,548
N/A	77-Y30-S02 OAK	Youth Table	27-1/2"H x 60" Diameter	140	N/A	\$2,548
N/A	77-J30-S02 OAK	Juvenile Table	25"H x 60" Diameter	140	N/A	\$2,548

Round Table

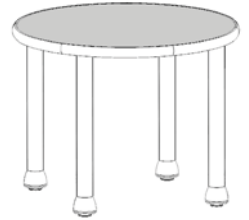

Round Maple Table						
77-109-S00 MAP	77-109-S02 MAP	Adult Table	29"H x 36" Diameter	100	\$2,236	\$2,143
77-Y09-S00 MAP	77-Y09-S02 MAP	Youth Table	27-1/2"H x 36" Diameter	100	\$2,236	\$2,143
77-J09-S00 MAP	77-J09-S02 MAP	Juvenile Table	25"H x 36" Diameter	100	\$2,236	\$2,143
77-129-S00 MAP	77-129-S02 MAP	Adult Table	29"H x 42" Diameter	110	\$2,368	\$2,274
77-Y29-S00 MAP	77-Y29-S02 MAP	Youth Table	27-1/2"H x 42" Diameter	110	\$2,368	\$2,274
77-J29-S00 MAP	77-J29-S02 MAP	Juvenile Table	25"H x 42" Diameter	110	\$2,368	\$2,274
77-141-S00 MAP	77-141-S02 MAP	Adult Table	29"H x 48" Diameter	120	\$2,368	\$2,274
77-Y41-S00 MAP	77-Y41-S02 MAP	Youth Table	27-1/2"H x 48" Diameter	120	\$2,368	\$2,274
77-J41-S00 MAP	77-J41-S02 MAP	Juvenile Table	25"H x 48" Diameter	120	\$2,368	\$2,274
N/A	77-130-S02 MAP	Adult Table	29"H x 60" Diameter	140	N/A	\$2,777
N/A	77-Y30-S02 MAP	Youth Table	27-1/2"H x 60" Diameter	140	N/A	\$2,777
N/A	77-J30-S02 MAP	Juvenile Table	25"H x 60" Diameter	140	N/A	\$2,777

Square Oak Table						
77-191-S00 OAK	77-191-S02 OAK	Adult Table	29" x 30" x 30"	110	\$1,617	\$1,470
77-Y91-S00 OAK	77-Y91-S02 OAK	Youth Table	27-1/2" x 30" x 30"	110	\$1,617	\$1,470
77-J91-S00 OAK	77-J91-S02 OAK	Juvenile Table	25" x 30" x 30"	110	\$1,617	\$1,470
77-137-S00 OAK	77-137-S02 OAK	Adult Table	29" x 42" x 42"	110	\$1,738	\$1,590
77-Y37-S00 OAK	77-Y37-S02 OAK	Youth Table	27-1/2" x 42" x 42"	110	\$1,738	\$1,590
77-J37-S00 OAK	77-J37-S02 OAK	Juvenile Table	25" x 42" x 42"	110	\$1,738	\$1,590
77-154-S00 OAK	77-154-S02 OAK	Adult Table	29" x 48" x 48"	110	\$1,872	\$1,725
77-Y54-S00 OAK	77-Y54-S02 OAK	Youth Table	27-1/2" x 48" x 48"	110	\$1,872	\$1,725
77-J54-S00 OAK	77-J54-S02 OAK	Juvenile Table	25" x 48" x 48"	110	\$1,872	\$1,725

Square Table

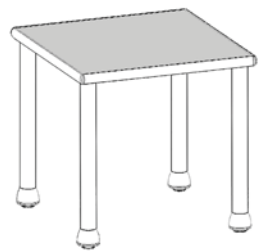



Square Maple Table						
77-191-S00 MAP	77-191-S02 MAP	Adult Table	29" x 30" x 30"	110	\$1,762	\$1,601
77-Y91-S00 MAP	77-Y91-S02 MAP	Youth Table	27-1/2" x 30" x 30"	110	\$1,762	\$1,601
77-J91-S00 MAP	77-J91-S02 MAP	Juvenile Table	25" x 30" x 30"	110	\$1,762	\$1,601
77-137-S00 MAP	77-137-S02 MAP	Adult Table	29" x 42" x 42"	110	\$1,894	\$1,733
77-Y37-S00 MAP	77-Y37-S02 MAP	Youth Table	27-1/2" x 42" x 42"	110	\$1,894	\$1,733
77-J37-S00 MAP	77-J37-S02 MAP	Juvenile Table	25" x 42" x 42"	110	\$1,894	\$1,733
77-154-S00 MAP	77-154-S02 MAP	Adult Table	29" x 48" x 48"	110	\$2,041	\$1,880
77-Y54-S00 MAP	77-Y54-S02 MAP	Youth Table	27-1/2" x 48" x 48"	110	\$2,041	\$1,880
77-J54-S00 MAP	77-J54-S02 MAP	Juvenile Table	25" x 48" x 48"	110	\$2,041	\$1,880

Please specify Wood Finish (Table 1) and High-Pressure Laminate (Table 2). Details can be found on page GEN 4.

The Horizons Collection

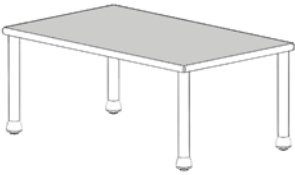
Reading Tables - Wood Legs

	Plywood Core Catalog No.	Particleboard Core Catalog No.	Description	H x W x D	Wt. (lbs.)	Plywood Core Price	Particleboard Core Price
Four-Reader Rectrangular Table 	<u>Four-Reader Rectangular Oak Table</u>						
	77-194-S00 OAK	77-194-S02 OAK	Adult Table	29" x 30" x 60"	120	\$1,911	\$1,728
	77-Y94-S00 OAK	77-Y94-S02 OAK	Youth Table	27-1/2" x 30" x 60"	120	\$1,911	\$1,728
	77-J94-S00 OAK	77-J94-S02 OAK	Juvenile Table	25" x 30" x 60"	120	\$1,911	\$1,728
	77-195-S00 OAK	77-195-S02 OAK	Adult Table	29" x 30" x 72"	140	\$2,051	\$1,869
	77-Y95-S00 OAK	77-Y95-S02 OAK	Youth Table	27-1/2" x 30" x 72"	140	\$2,051	\$1,869
	77-J95-S00 OAK	77-J95-S02 OAK	Juvenile Table	25" x 30" x 72"	140	\$2,051	\$1,869
	<u>Four-Reader Rectangular Maple Table</u>						
	77-194-S00 MAP	77-194-S02 MAP	Adult Table	29" x 30" x 60"	120	\$2,084	\$1,884
	77-Y94-S00 MAP	77-Y94-S02 MAP	Youth Table	27-1/2" x 30" x 60"	120	\$2,084	\$1,884
	77-J94-S00 MAP	77-J94-S02 MAP	Juvenile Table	25" x 30" x 60"	120	\$2,084	\$1,884
	77-195-S00 MAP	77-195-S02 MAP	Adult Table	29" x 30" x 72"	140	\$2,236	\$2,036
	77-Y95-S00 MAP	77-Y95-S02 MAP	Youth Table	27-1/2" x 30" x 72"	140	\$2,236	\$2,036
	77-J95-S00 MAP	77-J95-S02 MAP	Juvenile Table	25" x 30" x 72"	140	\$2,236	\$2,036
	Six-Reader Rectrangular Table 	<u>Six-Reader Rectangular Oak Table</u>					
77-144-S00 OAK		77-144-S02 OAK	Adult Table	29" x 36" x 60"	120	\$1,992	\$1,808
77-Y44-S00 OAK		77-Y44-S02 OAK	Youth Table	27-1/2" x 36" x 60"	120	\$1,992	\$1,808
77-J44-S00 OAK		77-J44-S02 OAK	Juvenile Table	25" x 36" x 60"	120	\$1,992	\$1,808
77-138-S00 OAK		77-138-S02 OAK	Adult Table	29" x 36" x 72"	140	\$2,132	\$1,948
77-Y38-S00 OAK		77-Y38-S02 OAK	Youth Table	27-1/2" x 36" x 72"	140	\$2,132	\$1,948
77-J38-S00 OAK		77-J38-S02 OAK	Juvenile Table	25" x 36" x 72"	140	\$2,132	\$1,948
77-145-S00 OAK		77-145-S02 OAK	Adult Table	29" x 48" x 72"	170	\$2,753	\$2,291
77-Y45-S00 OAK		77-Y45-S02 OAK	Youth Table	27-1/2" x 48" x 72"	170	\$2,753	\$2,291
77-J45-S00 OAK		77-J45-S02 OAK	Juvenile Table	25" x 48" x 72"	170	\$2,753	\$2,291
<u>Six-Reader Rectangular Maple Table</u>							
77-144-S00 MAP		77-144-S02 MAP	Adult Table	29" x 36" x 60"	120	\$2,172	\$1,971
77-Y44-S00 MAP		77-Y44-S02 MAP	Youth Table	27-1/2" x 36" x 60"	120	\$2,172	\$1,971
77-J44-S00 MAP		77-J44-S02 MAP	Juvenile Table	25" x 36" x 60"	120	\$2,172	\$1,971
77-138-S00 MAP		77-138-S02 MAP	Adult Table	29" x 36" x 72"	140	\$2,324	\$2,124
77-Y38-S00 MAP	77-Y38-S02 MAP	Youth Table	27-1/2" x 36" x 72"	140	\$2,324	\$2,124	
77-J38-S00 MAP	77-J38-S02 MAP	Juvenile Table	25" x 36" x 72"	140	\$2,324	\$2,124	
77-145-S00 MAP	77-145-S02 MAP	Adult Table	29" x 48" x 72"	170	\$3,001	\$2,496	
77-Y45-S00 MAP	77-Y45-S02 MAP	Youth Table	27-1/2" x 48" x 72"	170	\$3,001	\$2,496	
77-J45-S00 MAP	77-J45-S02 MAP	Juvenile Table	25" x 48" x 72"	170	\$3,001	\$2,496	

Please specify Wood Finish (Table 1) and High-Pressure Laminate (Table 2). Details can be found on page GEN 4.

Plywood Core Catalog No.	Particleboard Core Catalog No.	Description	H x W x D	Wt. (lbs.)	Plywood Core Price	Particleboard Core Price
<i>Rectangular Oak Table with Center Support Legs</i>						
77-198-S00 OAK	77-198-S02 OAK	Adult Table	29" x 30" x 90"	165	\$2,732	\$2,561
77-Y98-S00 OAK	77-Y98-S02 OAK	Youth Table	27-1/2" x 30" x 90"	165	\$2,732	\$2,561
77-J98-S00 OAK	77-J98-S02 OAK	Juvenile Table	25" x 30" x 90"	165	\$2,732	\$2,561
77-146-S00 OAK	77-146-S02 OAK	Adult Table	29" x 36" x 90"	165	\$2,813	\$2,641
77-Y46-S00 OAK	77-Y46-S02 OAK	Youth Table	27-1/2" x 36" x 90"	165	\$2,813	\$2,641
77-J46-S00 OAK	77-J46-S02 OAK	Juvenile Table	25" x 36" x 90"	165	\$2,813	\$2,641
77-134-S00 OAK	77-134-S02 OAK	Adult Table	29" x 48" x 90"	185	\$3,079	\$2,879
77-Y34-S00 OAK	77-Y34-S02 OAK	Youth Table	27-1/2" x 48" x 90"	185	\$3,079	\$2,879
77-J34-S00 OAK	77-J34-S02 OAK	Juvenile Table	25" x 48" x 90"	185	\$3,079	\$2,879
<i>Rectangular Maple Table with Center Support Legs</i>						
77-198-S00 MAP	77-198-S02 MAP	Adult Table	29" x 30" x 90"	165	\$2,979	\$2,791
77-Y98-S00 MAP	77-Y98-S02 MAP	Youth Table	27-1/2" x 30" x 90"	165	\$2,979	\$2,791
77-J98-S00 MAP	77-J98-S02 MAP	Juvenile Table	25" x 30" x 90"	165	\$2,979	\$2,791
77-146-S00 MAP	77-146-S02 MAP	Adult Table	29" x 36" x 90"	165	\$3,067	\$2,879
77-Y46-S00 MAP	77-Y46-S02 MAP	Youth Table	27-1/2" x 36" x 90"	165	\$3,067	\$2,879
77-J46-S00 MAP	77-J46-S02 MAP	Juvenile Table	25" x 36" x 90"	165	\$3,067	\$2,879
77-134-S00 MAP	77-134-S02 MAP	Adult Table	29" x 48" x 90"	185	\$3,357	\$3,138
77-Y34-S00 MAP	77-Y34-S02 MAP	Youth Table	27-1/2" x 48" x 90"	185	\$3,357	\$3,138
77-J34-S00 MAP	77-J34-S02 MAP	Juvenile Table	25" x 48" x 90"	185	\$3,357	\$3,138

Rectangular Table with Center Support Legs

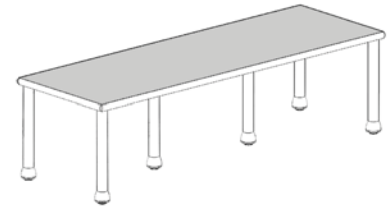

Please specify Wood Finish (Table 1) and High-Pressure Laminate (Table 2). Details can be found on page GEN 4.

General Specifications

TABLETOPS

Standard tabletops are 1-3/16" thick, 5-ply solid-lumber core, except 90"W tables which have a 1-3/16" thick particleboard core, including a top surface of .050" thick, high-pressure laminate, with a backing sheet not less than .020" thickness for balanced construction. High-pressure laminate has a lo-glare finish resistant to scratches, fading, and staining that meets or exceeds NEMA standards. Edges are solid maple. Drop edge band is 5/8" thick x 1-5/8" externally banded to form a bullnose.

TABLE LEGS

Each leg is 2-1/2" diameter, 16-gauge steel tubing and has a 3-1/2" diameter x 2-5/8"H glued-up maple bun-foot as a design feature. Each bun-foot has a 2" diameter, adjustable glide mounted in a recessed tee-nut. The glide is further recessed into the bun-foot by means of a counter-sunk boring which accepts the upper two-thirds of the glide. Legs attach to tabletops by means of a 5" square x 5/16" thick cold-rolled steel plate. The plate is fillet-welded to the leg. The steel plate is attached to the tabletop by five 5/16" x 1" machine bolts engaging internally and externally threaded bushings in the underside of the tabletop. Leg plates are positioned behind, and be hidden by, the extended table edge band.

TABLETOP SUPPORT

For maximum rigidity, rectangular tables, 60" or more wide, receive a V-shaped, 14-gauge steel keel securely fastened to the underside of the tabletop. Tables 48"D and more than 60"W, receive two steel keels parallel to the length of the table. Tables 90" or wider receive two extra matching legs located under the center of the table to provide added support.

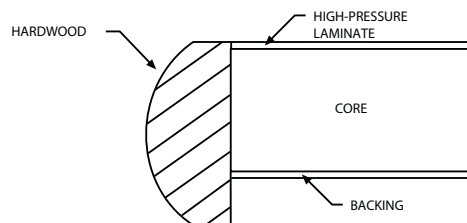

Horizons Drop Edge

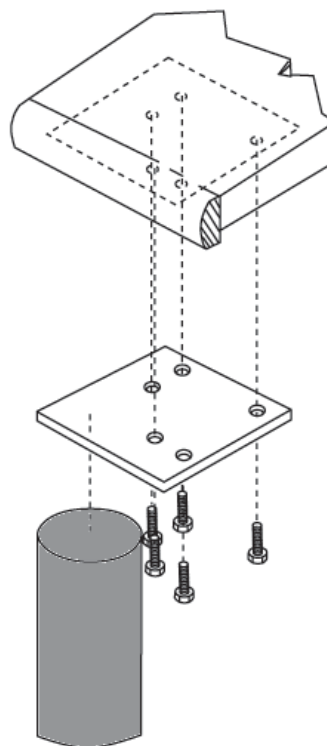

Horizons Metal Leg



Horizons External Edge Band

Plywood Core Catalog No.	Particleboard Core Catalog No.	Description	H x W x D	Wt. (lbs.)	Plywood Core Price	Particleboard Core Price
Round Oak Table						
77M-109-S00 OAK	77M-109-S02 OAK	Adult Table	29"H x 36" Diameter	100	\$2,159	\$2,025
77M-Y09-S00 OAK	77M-Y09-S02 OAK	Youth Table	27-1/2"H x 36" Diameter	100	\$2,159	\$2,025
77M-J09-S00 OAK	77M-J09-S02 OAK	Juvenile Table	25"H x 36" Diameter	100	\$2,159	\$2,025
77M-129-S00 OAK	77M-129-S02 OAK	Adult Table	29"H x 42" Diameter	110	\$2,280	\$2,145
77M-Y29-S00 OAK	77M-Y29-S02 OAK	Youth Table	27-1/2"H x 42" Diameter	110	\$2,280	\$2,145
77M-J29-S00 OAK	77M-J29-S02 OAK	Juvenile Table	25"H x 42" Diameter	110	\$2,280	\$2,145
77M-141-S00 OAK	77M-141-S02 OAK	Adult Table	29"H x 48" Diameter	120	\$2,280	\$2,145
77M-Y41-S00 OAK	77M-Y41-S02 OAK	Youth Table	27-1/2"H x 48" Diameter	120	\$2,280	\$2,145
77M-J41-S00 OAK	77M-J41-S02 OAK	Juvenile Table	25"H x 48" Diameter	120	\$2,280	\$2,145
N/A	77M-130-S02 OAK	Adult Table	29"H x 60" Diameter	140	N/A	\$2,575
N/A	77M-Y30-S02 OAK	Youth Table	27-1/2"H x 60" Diameter	140	N/A	\$2,575
N/A	77M-J30-S02 OAK	Juvenile Table	25"H x 60" Diameter	140	N/A	\$2,575

Round Table

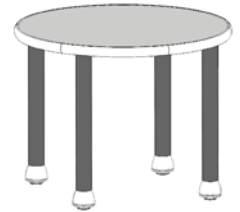

Round Maple Table						
77M-109-S00 MAP	77M-109-S02 MAP	Adult Table	29"H x 36" Diameter	100	\$2,353	\$2,207
77M-Y09-S00 MAP	77M-Y09-S02 MAP	Youth Table	27-1/2"H x 36" Diameter	100	\$2,353	\$2,207
77M-J09-S00 MAP	77M-J09-S02 MAP	Juvenile Table	25"H x 36" Diameter	100	\$2,353	\$2,207
77M-129-S00 MAP	77M-129-S02 MAP	Adult Table	29"H x 42" Diameter	110	\$2,485	\$2,338
77M-Y29-S00 MAP	77M-Y29-S02 MAP	Youth Table	27-1/2"H x 42" Diameter	110	\$2,485	\$2,338
77M-J29-S00 MAP	77M-J29-S02 MAP	Juvenile Table	25"H x 42" Diameter	110	\$2,485	\$2,338
77M-141-S00 MAP	77M-141-S02 MAP	Adult Table	29"H x 48" Diameter	120	\$2,485	\$2,338
77M-Y41-S00 MAP	77M-Y41-S02 MAP	Youth Table	27-1/2"H x 48" Diameter	120	\$2,485	\$2,338
77M-J41-S00 MAP	77M-J41-S02 MAP	Juvenile Table	25"H x 48" Diameter	120	\$2,485	\$2,338
N/A	77M-130-S02 MAP	Adult Table	29"H x 60" Diameter	140	N/A	\$2,806
N/A	77M-Y30-S02 MAP	Youth Table	27-1/2"H x 60" Diameter	140	N/A	\$2,806
N/A	77M-J30-S02 MAP	Juvenile Table	25"H x 60" Diameter	140	N/A	\$2,806

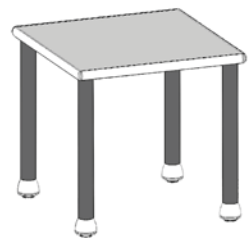

Square Oak Table						
77M-191-S00 OAK	77M-191-S02 OAK	Adult Table	29" x 30" x 30"	110	\$1,744	\$1,571
77M-Y91-S00 OAK	77M-Y91-S02 OAK	Youth Table	27-1/2" x 30" x 30"	110	\$1,744	\$1,571
77M-J91-S00 OAK	77M-J91-S02 OAK	Juvenile Table	25" x 30" x 30"	110	\$1,744	\$1,571
77M-137-S00 OAK	77M-137-S02 OAK	Adult Table	29" x 42" x 42"	110	\$1,865	\$1,692
77M-Y37-S00 OAK	77M-Y37-S02 OAK	Youth Table	27-1/2" x 42" x 42"	110	\$1,865	\$1,692
77M-J37-S00 OAK	77M-J37-S02 OAK	Juvenile Table	25" x 42" x 42"	110	\$1,865	\$1,692
77M-154-S00 OAK	77M-154-S02 OAK	Adult Table	29" x 48" x 48"	110	\$1,999	\$1,827
77M-Y54-S00 OAK	77M-Y54-S02 OAK	Youth Table	27-1/2" x 48" x 48"	110	\$1,999	\$1,827
77M-J54-S00 OAK	77M-J54-S02 OAK	Juvenile Table	25" x 48" x 48"	110	\$1,999	\$1,827

Square Table



Square Maple Table						
77M-191-S00 MAP	77M-191-S02 MAP	Adult Table	29" x 30" x 30"	110	\$1,901	\$1,712
77M-Y91-S00 MAP	77M-Y91-S02 MAP	Youth Table	27-1/2" x 30" x 30"	110	\$1,901	\$1,712
77M-J91-S00 MAP	77M-J91-S02 MAP	Juvenile Table	25" x 30" x 30"	110	\$1,901	\$1,712
77M-137-S00 MAP	77M-137-S02 MAP	Adult Table	29" x 42" x 42"	110	\$2,033	\$1,844
77M-Y37-S00 MAP	77M-Y37-S02 MAP	Youth Table	27-1/2" x 42" x 42"	110	\$2,033	\$1,844
77M-J37-S00 MAP	77M-J37-S02 MAP	Juvenile Table	25" x 42" x 42"	110	\$2,033	\$1,844
77M-154-S00 MAP	77M-154-S02 MAP	Adult Table	29" x 48" x 48"	110	\$2,180	\$1,991
77M-Y54-S00 MAP	77M-Y54-S02 MAP	Youth Table	27-1/2" x 48" x 48"	110	\$2,180	\$1,991
77M-J54-S00 MAP	77M-J54-S02 MAP	Juvenile Table	25" x 48" x 48"	110	\$2,180	\$1,991

Please specify Wood Finish (Table 1) High-Pressure Laminate (Table 2) and Metal Color (Table 3). Details can be found on pages GEN 4 and GEN 5.

	Plywood Core Catalog No.	Particleboard Core Catalog No.	Description	H x W x D	Wt. (lbs.)	Plywood Core Price	Particleboard Core Price
Four-Reader Rectrangular Table 	<u>Four-Reader Rectangular Oak Table</u>						
	77M-194-S00 OAK	77M-194-S02 OAK	Adult Table	29" x 30" x 60"	120	\$2,045	\$1,832
	77M-Y94-S00 OAK	77M-Y94-S02 OAK	Youth Table	27-1/2" x 30" x 60"	120	\$2,045	\$1,832
	77M-J94-S00 OAK	77M-J94-S02 OAK	Juvenile Table	25" x 30" x 60"	120	\$2,045	\$1,832
	77M-195-S00 OAK	77M-195-S02 OAK	Adult Table	29" x 30" x 72"	140	\$2,154	\$1,973
	77M-Y95-S00 OAK	77M-Y95-S02 OAK	Youth Table	27-1/2" x 30" x 72"	140	\$2,154	\$1,973
	77M-J95-S00 OAK	77M-J95-S02 OAK	Juvenile Table	25" x 30" x 72"	140	\$2,154	\$1,973
	<u>Four-Reader Rectangular Maple Table</u>						
	77M-194-S00 MAP	77M-194-S02 MAP	Adult Table	29" x 30" x 60"	120	\$2,229	\$1,997
	77M-Y94-S00 MAP	77M-Y94-S02 MAP	Youth Table	27-1/2" x 30" x 60"	120	\$2,229	\$1,997
	77M-J94-S00 MAP	77M-J94-S02 MAP	Juvenile Table	25" x 30" x 60"	120	\$2,229	\$1,997
	77M-195-S00 MAP	77M-195-S02 MAP	Adult Table	29" x 30" x 72"	140	\$2,348	\$2,150
77M-Y95-S00 MAP	77M-Y95-S02 MAP	Youth Table	27-1/2" x 30" x 72"	140	\$2,348	\$2,150	
77M-J95-S00 MAP	77M-J95-S02 MAP	Juvenile Table	25" x 30" x 72"	140	\$2,348	\$2,150	
Six-Reader Rectrangular Table 	<u>Six-Reader Rectangular Oak Table</u>						
	77M-144-S00 OAK	77M-144-S02 OAK	Adult Table	29" x 36" x 60"	120	\$2,099	\$1,911
	77M-Y44-S00 OAK	77M-Y44-S02 OAK	Youth Table	27-1/2" x 36" x 60"	120	\$2,099	\$1,911
	77M-J44-S00 OAK	77M-J44-S02 OAK	Juvenile Table	25" x 36" x 60"	120	\$2,099	\$1,911
	77M-138-S00 OAK	77M-138-S02 OAK	Adult Table	29" x 36" x 72"	140	\$2,235	\$2,052
	77M-Y38-S00 OAK	77M-Y38-S02 OAK	Youth Table	27-1/2" x 36" x 72"	140	\$2,235	\$2,052
	77M-J38-S00 OAK	77M-J38-S02 OAK	Juvenile Table	25" x 36" x 72"	140	\$2,235	\$2,052
	77M-145-S00 OAK	77M-145-S02 OAK	Adult Table	29" x 48" x 72"	170	\$2,856	\$2,394
	77M-Y45-S00 OAK	77M-Y45-S02 OAK	Youth Table	27-1/2" x 48" x 72"	170	\$2,856	\$2,394
	77M-J45-S00 OAK	77M-J45-S02 OAK	Juvenile Table	25" x 48" x 72"	170	\$2,856	\$2,394
	<u>Six-Reader Rectangular Maple Table</u>						
	77M-144-S00 MAP	77M-144-S02 MAP	Adult Table	29" x 36" x 60"	120	\$2,287	\$2,084
	77M-Y44-S00 MAP	77M-Y44-S02 MAP	Youth Table	27-1/2" x 36" x 60"	120	\$2,287	\$2,084
	77M-J44-S00 MAP	77M-J44-S02 MAP	Juvenile Table	25" x 36" x 60"	120	\$2,287	\$2,084
	77M-138-S00 MAP	77M-138-S02 MAP	Adult Table	29" x 36" x 72"	140	\$2,436	\$2,237
	77M-Y38-S00 MAP	77M-Y38-S02 MAP	Youth Table	27-1/2" x 36" x 72"	140	\$2,436	\$2,237
	77M-J38-S00 MAP	77M-J38-S02 MAP	Juvenile Table	25" x 36" x 72"	140	\$2,436	\$2,237
	77M-145-S00 MAP	77M-145-S02 MAP	Adult Table	29" x 48" x 72"	170	\$3,113	\$2,609
77M-Y45-S00 MAP	77M-Y45-S02 MAP	Youth Table	27-1/2" x 48" x 72"	170	\$3,113	\$2,609	
77M-J45-S00 MAP	77M-J45-S02 MAP	Juvenile Table	25" x 48" x 72"	170	\$3,113	\$2,609	

Please specify Wood Finish (Table 1) High-Pressure Laminate (Table 2) and Metal Color (Table 3). Details can be found on pages GEN 4 and GEN 5.

Plywood Core Catalog No.	Particleboard Core Catalog No.	Description	H x W x D	Wt. (lbs.)	Plywood Core Price	Particleboard Core Price
<i>Rectangular Oak Table with Center Support Legs</i>						
77M-198-S00 OAK	77M-198-S02 OAK	Adult Table	29" x 30" x 90"	165	\$2,732	\$2,710
77M-Y98-S00 OAK	77M-Y98-S02 OAK	Youth Table	27-1/2" x 30" x 90"	165	\$2,732	\$2,710
77M-J98-S00 OAK	77M-J98-S02 OAK	Juvenile Table	25" x 30" x 90"	165	\$2,732	\$2,710
77M-146-S00 OAK	77M-146-S02 OAK	Adult Table	29" x 36" x 90"	165	\$3,006	\$2,790
77M-Y46-S00 OAK	77M-Y46-S02 OAK	Youth Table	27-1/2" x 36" x 90"	165	\$3,006	\$2,790
77M-J46-S00 OAK	77M-J46-S02 OAK	Juvenile Table	25" x 36" x 90"	165	\$3,006	\$2,790
77M-134-S00 OAK	77M-134-S02 OAK	Adult Table	29" x 48" x 90"	185	\$3,272	\$3,072
77M-Y34-S00 OAK	77M-Y34-S02 OAK	Youth Table	27-1/2" x 48" x 90"	185	\$3,272	\$3,072
77M-J34-S00 OAK	77M-J34-S02 OAK	Juvenile Table	25" x 48" x 90"	185	\$3,272	\$3,072
<i>Rectangular Maple Table with Center Support Legs</i>						
77M-198-S00 MAP	77M-198-S02 MAP	Adult Table	29" x 30" x 90"	165	\$2,979	\$2,954
77M-Y98-S00 MAP	77M-Y98-S02 MAP	Youth Table	27-1/2" x 30" x 90"	165	\$2,979	\$2,954
77M-J98-S00 MAP	77M-J98-S02 MAP	Juvenile Table	25" x 30" x 90"	165	\$2,979	\$2,954
77M-146-S00 MAP	77M-146-S02 MAP	Adult Table	29" x 36" x 90"	165	\$3,277	\$3,041
77M-Y46-S00 MAP	77M-Y46-S02 MAP	Youth Table	27-1/2" x 36" x 90"	165	\$3,277	\$3,041
77M-J46-S00 MAP	77M-J46-S02 MAP	Juvenile Table	25" x 36" x 90"	165	\$3,277	\$3,041
77M-134-S00 MAP	77M-134-S02 MAP	Adult Table	29" x 48" x 90"	185	\$3,567	\$3,349
77M-Y34-S00 MAP	77M-Y34-S02 MAP	Youth Table	27-1/2" x 48" x 90"	185	\$3,567	\$3,349
77M-J34-S00 MAP	77M-J34-S02 MAP	Juvenile Table	25" x 48" x 90"	185	\$3,567	\$3,349

Rectangular Table with Center Support Legs

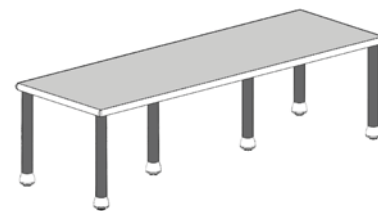

Please specify Wood Finish (Table 1) High-Pressure Laminate (Table 2) and Metal Color (Table 3). Details can be found on pages GEN 4 and GEN 5.

General Specifications

WORKSTATIONS

Workstations are of modular starter and adder design, with overall height 33". Workstations are available in 36", 48", 72", 96" and 108" widths. A knee-space panel located below the work surface supports all work surfaces greater than 48"W. Work surface height is 27-1/2". Work surface depth is 27-1/2" with an additional 1-1/2"W cord drop between the work surface and back panel to allow passage of electrical cords. Work surface is attached to end and intermediate panels by means of two metal 22-1/2" long "Z" brackets with 5/16" – 18 hex-head bolts engaging internally and externally threaded bushings embedded into panels. The back panel is attached to end and intermediate panels using hidden metal keyways and shoulder screws. The shelf is attached to end and intermediate panels and back panels with 3/4" x 3/4" steel, black painted angle brackets and black #8 screws.

WORK SURFACE

Standard work surface is 1-3/16" thick, 3-ply, 45# density particleboard, including a top surface of .050" thick, high-pressure laminate, with a backing sheet not less than .020" thickness for balanced construction. High-pressure laminate has a lo-glare finish resistant to scratches, fading, and staining that meets or exceeds NEMA standards. Front edge of work surface has a 5/8" x 1-5/8" solid maple edge band in a half-round bullnose shape. The back edge of the top has a black plastic band 1-1/2"W which projects above the work surface 1/4" to act as a retainer.

END AND INTERMEDIATE PANELS

End panels are 1" thick and intermediate panels are 1-3/16" thick particleboard with select face veneers of maple wood. All edges are banded with a 5/8" maple wood edge band. Intermediate panels receive a 3" diameter grommet below the work surface to allow passage of electrical and data wires. Each panel receives two 1-1/4" adjustable glides.

BACK PANEL

Back panel is 3/4" thick, 45# density particleboard core with face veneers of select maple wood. The top and bottom edges of the back panel receive 1.6mm thick maple wood edge bands. Back panels attach to end and intermediate panels by means of recessed metal fasteners and shoulder screws. The back panel on double-faced units receives a 3" diameter grommet located below the work surface to allow passage of electrical and data wires.

DESIGN CUTOUTS

The wooden 1" thick end panels have a laser cut out design as selected by the customer. The inside edges of the cutout are blackened to provide a finished appearance. Cutouts are available on starter units only (end panels).

SHELF

Shelf is 3/4" thick x 8"D 45# density particleboard core with face veneers of select maple wood. Shelf is banded on the front edge with a 1.6mm maple wood band. Shelf attaches to end and intermediate panels by means of a pair of metal "L" brackets. Back corners of shelf have a 3" x 3" cutout to allow for the passage of electrical cords. The shelf is positioned 10" below the bottom of the work surface.

WIRE MANAGEMENT DOOR



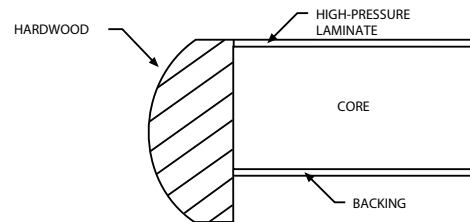

The wire management door is positioned between the bottom of the work surface and the shelf and is designed to form a concealed wire management channel 8-1/2"H x 9-1/2"D. The door is 1/4" thick with select maple wood face veneers. The door slides in two aluminum tracks, one that is attached to the bottom of the work surface while the other is attached to the top of the shelf.

KNEE-SPACE PANEL

All 72" and 96"W workstations, as well as functional corner units, have a knee-space panel positioned under the work surface for additional work surface support. Units 108"W have two knee-space panels. The knee-space panel is 1-1/8" thick, 45# density particleboard core with select face veneers of maple wood. The panel is banded on exposed edges with a 1.6mm maple wood band. The knee-space panel is attached to the back panel using a 1-3/4" square post, grooved to receive the knee space panel and back panels. Panels attach to the post using recessed metal fasteners and shoulder screws. The knee-space panel is angled in the back to create a space to allow passage of electrical and data cords. The knee-space panel receives two 1-1/4" diameter black adjustable glides.



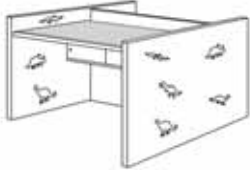



Horizons Drop Edge

Oak Catalog No.	Maple Catalog No.	Description	H x W x D	Wt. (lbs.)	Oak Price	Maple Price	
<u>36" Wide Working Space</u>							Single-Faced One-Position Starter 
77-S31-SS0 OAK	77-S31-SS0 MAP	One-Position S/F Starter	33-1/2" x 37-1/2" x 31"	130	\$2,348	\$2,560	
77-S31-SAO OAK	77-S31-SAO MAP	One-Position S/F Adder	33-1/2" x 36-1/2" x 31"	100	\$1,751	\$1,909	
<u>48" Wide Working Space</u>							Adder 
77-S41-SS0 OAK	77-S41-SS0 MAP	One-Position S/F Starter	33-1/2" x 49-1/4" x 31"	155	\$2,496	\$2,721	
77-S41-SAO OAK	77-S41-SAO MAP	One-Position S/F Adder	33-1/2" x 48" x 31"	125	\$1,860	\$2,028	
<u>36" Wide Working Space</u>							Double-Faced One-Position Starter 
77-D31-SS0 OAK	77-D31-SS0 MAP	One-Position D/F Starter	33-1/2" x 37-1/2" x 59-1/2"	215	\$4,282	\$4,668	
77-D31-SAO OAK	77-D31-SAO MAP	One-Position D/F Adder	33-1/2" x 36-1/2" x 59-1/2"	155	\$3,120	\$3,401	
<u>48" Wide Working Space</u>							Adder 
77-D41-SS0 OAK	77-D41-SS0 MAP	One-Position D/F Starter	33-1/2" x 49-1/4" x 59-1/2"	255	\$4,539	\$4,947	
77-D41-SAO OAK	77-D41-SAO MAP	One-Position D/F Adder	33-1/2" x 48" x 59-1/2"	195	\$3,356	\$3,658	

Please specify Wood Finish (Table 1) and High-Pressure Laminate (Table 2). Details can be found on page GEN 4.

Note: Specify Cutout Design. Details can be found on page HOR 32.

	Oak Catalog No.	Maple Catalog No.	Description	H x W x D	Wt. (lbs.)	Oak Price	Maple Price
Single-Faced Two-Position Starter 	<i>36" Wide Working Space</i>						
	77-S32-SS0 OAK	77-S32-SS0 MAP	Two-Position S/F Starter	33-1/2" x 74" x 31"	195	\$3,160	\$3,444
	77-S32-SAO OAK	77-S32-SAO MAP	Two-Position S/F Adder	33-1/2" x 73" x 31"	165	\$2,525	\$2,752
Adder 	<i>48" Wide Working Space</i>						
	77-S42-SS0 OAK	77-S42-SS0 MAP	Two-Position S/F Starter	33-1/2" x 97-1/4" x 31"	235	\$3,401	\$3,707
	77-S42-SAO OAK	77-S42-SAO MAP	Two-Position S/F Adder	33-1/2" x 96" x 31"	205	\$2,752	\$3,001
Double-Faced Two-Position Starter 	<i>36" Wide Working Space</i>						
	77-D32-SS0 OAK	77-D32-SS0 MAP	Two-Position D/F Starter	33-1/2" x 74" x 59-1/2"	330	\$5,702	\$6,215
	77-D32-SAO OAK	77-D32-SAO MAP	Two-Position D/F Adder	33-1/2" x 73" x 59-1/2"	270	\$4,567	\$4,978
Adder 	<i>48" Wide Working Space</i>						
	77-D42-SS0 OAK	77-D42-SS0 MAP	Two-Position D/F Starter	33-1/2" x 97-1/4" x 59-1/2"	410	\$6,117	\$6,668
	77-D42-SAO OAK	77-D42-SAO MAP	Two-Position D/F Adder	33-1/2" x 96" x 59-1/2"	155	\$4,977	\$5,425

Please specify Wood Finish (Table 1) and High-Pressure Laminate (Table 2). Details can be found on page GEN 4.

Note: Specify Cutout Design. Details can be found on page HOR 32.

Oak Catalog No.	Maple Catalog No.	Description	H x W x D	Wt. (lbs.)	Oak Price	Maple Price
-----------------	-------------------	-------------	-----------	------------	-----------	-------------

36" Wide Working Space

Single-Faced Three-Position Starter

77-S33-SS0 OAK	77-S33-SS0 MAP	Three-Position S/F Starter	33-1/2" x 110-1/2" x 31"	260	\$4,125	\$4,496
----------------	----------------	----------------------------	--------------------------	-----	---------	---------



77-S33-SAO OAK	77-S33-SAO MAP	Three-Position S/F Adder	33-1/2" x 109-1/4" x 31"	230	\$3,322	\$3,621
----------------	----------------	--------------------------	--------------------------	-----	---------	---------

Adder



36" Wide Working Space

Double-Faced Three-Position Starter

77-D33-SS0 OAK	77-D33-SS0 MAP	Three-Position D/F Starter	33-1/2" x 110-1/2" x 59-1/2"	445	\$7,456	\$8,127
----------------	----------------	----------------------------	------------------------------	-----	---------	---------



77-D33-SAO OAK	77-D33-SAO MAP	Three Position D/F Adder	33-1/2" x 109-1/4" x 59-1/2"	385	\$6,263	\$6,826
----------------	----------------	--------------------------	------------------------------	-----	---------	---------

Adder



Please specify Wood Finish (Table 1) and High-Pressure Laminate (Table 2). Details can be found on page GEN 4.

Note: Specify Cutout Design. Details can be found on page HOR 32.

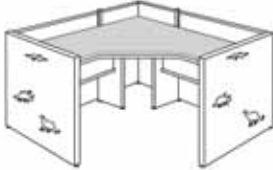
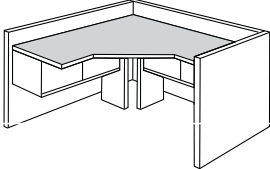
	Oak Catalog No.	Maple Catalog No.	Description	H x W x D	Wt. (lbs.)	Oak Price	Maple Price
90° Functional Corner Unit Starter 							
	<i>36" Wide Working Space</i>						
	77-SCR-SS0 OAK	77-SCR-SS0 MAP	90-Degree Functional Corner Starter	33-1/2" x 62" x 31"	225	\$4,937	\$5,381
Adder 							
	77-SCR-SA0 OAK	77-SCR-SA0 MAP	90-Degree Functional Corner Adder	33-1/2" x 62" x 31"	195	\$4,432	\$4,831

Please specify Wood Finish (Table 1) and High-Pressure Laminate (Table 2). Details can be found on page GEN 4.

Note: Specify Cutout Design. Details can be found on page HOR 32.

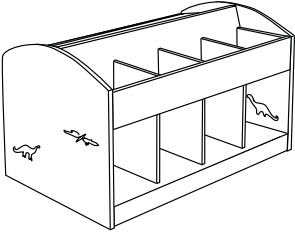
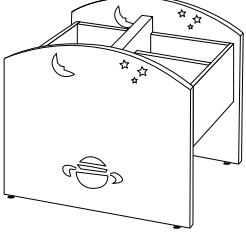
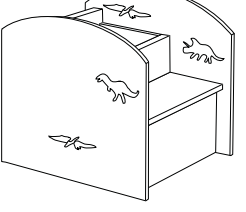
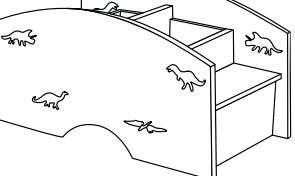
Oak Catalog No.	Maple Catalog No.	Description	H x W x D	Wt. (lbs.)	Oak Price	Maple Price	
77-112-S00 OAK	77-112-S00 MAP	D/F Book Browser with 2 Cutouts per panel Maple plywood construction. The top portion has (8) 13"W x 14"D display compartments. The bottom portion has (8) 16-1/2"H x 13"W x 17"D storage compartments. The unit is movable on four hidden casters (which are supplied). Each caster has a load rating of 175# for a total of 700#s. Design cutouts: The wooden 1" thick end panels have a 34" radius on the top edge and have a laser cut chosen by the customer. The inside edges of the cutout are blackened to provide a finished appearance.	33-3/4" x 57-3/4" x 35-3/4"	300	\$6,509	\$7,095	Double-Faced Mobile Book Browser with 2 Cutouts per Panel 
77-262-S00 OAK	77-262-S00 MAP	D/F Book Mobile Browser with 3 Cutouts per panel Maple plywood construction. The top portion has (4) 10-3/8"W x 9-13/16"D display compartments. Each end panel receives two floor leveling glides. Design cutouts: The wooden 1" thick end panels have a 24" radius on the top edge and have a laser cut chosen by the customer. The inside edges of the cutout are blackened to provide a finished appearance.	23" x 25" x 25"	200	\$2,704	\$2,947	Double-Faced Book Browser with 3 Cutouts per Panel 
77-263-S00 OAK	77-263-S00 MAP	S/F Book Mobile Browser with 2 Cutouts per panel Maple plywood construction. The top portion has (2) 10-3/8"W x 9-13/16"D display compartments as well as (1) bench seat. Each end panel receives two floor leveling glides. Design cutouts: The wooden 1" thick end panels have a 25" radius on the top edge and have a laser cut chosen by the customer. The inside edges of the cutout are blackened to provide a finished appearance.	24-3/4" x 25" x 23*3/4"	140	\$2,930	\$3,194	Single-Faced Mobile Book Browser with Seat and 2 Cutouts per Panel 
77-264-S00 OAK	77-264-S00 MAP	D/F Book Mobile Browser with 4 Cutouts per panel Maple plywood construction. The top portion has (4) 10-3/8"W x 9-13/16"D display compartments as well as (2) bench seats, 23" W x 10" D. Each end panel receives two floor leveling glides. Design cutouts: The wooden 1" thick end panels have a 52-1/2" radius on the top edge and have a laser cut chosen by the customer. The inside edges of the cutout are blackened to provide a finished appearance.	24-5/8" x 25" x 45"	190	\$3,792	\$4,133	Double-Faced Mobile Book Browser with Seat and 4 Cutouts per Panel 

Please specify Wood Finish (Table 1) and High-Pressure Laminate (Table 2). Details can be found on page GEN 4.

Note: Specify Cutout Design. Details can be found on page HOR 32.

	Oak Catalog No.	Maple Catalog No.	Description	H x W x D	Wt. (lbs.)	Oak Price	Maple Price
Picture Book Displayer with Cutout	77-140-S00 OAK	77-140-S00 MAP	Picture Book Table with 3 Cutouts per panel	31-1/2" x 48-1/2" x 34-1/2"	100	\$3,506	\$3,822
	77-142-S00 OAK	77-142-S00 MAP	Picture Book Table with 3 Cutouts per panel	31-1/2" x 78-1/2" x 34-1/2"	190	\$3,896	\$4,247

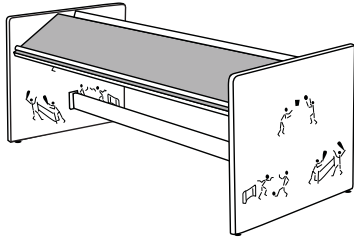

Sloped tops are 1-3/16" thick, particleboard core, including a top surface of .050" thick, high-pressure laminate, with a backing sheet not less than .020" thickness for balanced construction. High-pressure laminate has a lo-glare finish resistant to scratches, fading, and staining that meets or exceeds NEMA standards. Edges are solid maple. The edge band is 5/8" thick, externally banded to form a bullnose. Loaded in the center of the table, between the two tops, is a display book bin 3-3/4"W running the full length of the table.

Design cutouts: The wooden 1" thick end panels have a 24" radius on the top edge and have a laser cut chosen by the customer. The inside edges of the cutout are blackened to provide a finished appearance.

Note: Hassocks for Picture Book Tables are located in the Display Specialty Seating Section page 15.

Please specify Wood Finish (Table 1) and High-Pressure Laminate (Table 2). Details can be found on page GEN 4.

Note: Specify Cutout Design. Details can be found on page HOR 32.

General Specifications

END PANELS

The end panel is of maple plywood construction 1-1/4" thick with 1.6mm banded edges. The end panel has a large cutout design as selected by the customer. The inside edges of the cutouts are blackened to provide a finished appearance. When the cutout design is large enough, a matching cutout of colored high-pressure laminate is inlaid in the cutout of the panel. When the cutout is small (such as the sports stick figures) no high-pressure laminate is inlaid but the panel is 1" thick maple plywood construction and the cutout goes completely through the panel. End panels are not machined. No fastening hardware is provided with end panels.

End panels for steel shelving with continuous tops or canopy top inset are designed to have the canopy top "inset" between the end panels.

Note: Exact height and depth of panel must be specified when ordering.

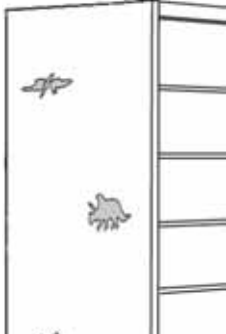
Oak Catalog No.	Maple Catalog No.	Description	# of Cutouts per Panel	Wt. (lbs.)	Oak Price	Maple Price		
77L-702-MOD OAK	77L-702-MOD MAP	43-3/4" x 13-7/8"	3	14	\$1,025	\$1,076	Single-Faced w/Laser Cutouts & Laminate Inlays End Panels	
77L-703-MOD OAK	77L-703-MOD MAP	43-3/4" x 15-7/8"	3	16	\$1,032	\$1,083		
77L-705-MOD OAK	77L-705-MOD MAP	67-3/4" x 13-7/8"	4	21	\$1,290	\$1,354		
77L-706-MOD OAK	77L-706-MOD MAP	67-3/4" x 15-7/8"	4	26	\$1,301	\$1,366		
77L-708-MOD OAK	77L-708-MOD MAP	79-3/4" x 13-7/8"	4	25	\$1,375	\$1,443		
77L-709-MOD OAK	77L-709-MOD MAP	79-3/4" x 15-7/8"	4	30	\$1,390	\$1,459		
77L-711-MOD OAK	77L-711-MOD MAP	85-3/4" x 13-7/8"	4	28	\$1,415	\$1,486		
77L-712-MOD OAK	77L-712-MOD MAP	85-3/4" x 15-7/8"	4	33	\$1,432	\$1,504		
77L-714-MOD OAK	77L-714-MOD MAP	91-3/4" x 13-7/8"	5	29	\$1,552	\$1,630		
77L-715-MOD OAK	77L-715-MOD MAP	91-3/4" x 15-7/8"	5	35	\$1,568	\$1,647		
77L-722-MOD OAK	77L-722-MOD MAP	43-3/4" x 24-3/8"	3	27	\$1,110	\$1,166		Double-Faced w/Laser Cutouts & Laminate Inlays End Panels
77L-723-MOD OAK	77L-723-MOD MAP	43-3/4" x 28-3/8"	3	33	\$1,127	\$1,184		
77L-725-MOD OAK	77L-725-MOD MAP	67-3/4" x 24-3/8"	4	43	\$1,447	\$1,519		
77L-726-MOD OAK	77L-726-MOD MAP	67-3/4" x 28-3/8"	4	52	\$1,467	\$1,541		
77L-728-MOD OAK	77L-728-MOD MAP	79-3/4" x 24-3/8"	4	51	\$1,540	\$1,617		
77L-729-MOD OAK	77L-729-MOD MAP	79-3/4" x 28-3/8"	4	61	\$1,563	\$1,641		
77L-731-MOD OAK	77L-731-MOD MAP	85-3/4" x 24-3/8"	4	55	\$1,586	\$1,665		
77L-732-MOD OAK	77L-732-MOD MAP	85-3/4" x 28-3/8"	4	66	\$1,612	\$1,692		
77L-734-MOD OAK	77L-734-MOD MAP	91-3/4" x 24-3/8"	5	59	\$1,728	\$1,814		
77L-735-MOD OAK	77L-735-MOD MAP	91-3/4" x 28-3/8"	5	60	\$1,753	\$1,840		

Please specify Wood Finish (Table 1) and High-Pressure Laminate (Table 2). Details can be found on page GEN 4.

Note: Specify Cutout Design. Details can be found on page HOR 32.

General Specifications

CHAIR FRAME

Each frame member is constructed from 1-1/4" hardwoods. All frame joints are mortised, tenoned and glued. All frames have a 3/4" solid hardwood support brace in each corner to give the chair added strength. All seats are fastened with six "Z" brackets routed into the frame and screwed into the bottom of the seat.

CHAIR SEAT

Chair seats are 1/2" thick bent multi-ply faced with select hardwood veneers.

UPHOLSTERED SEAT

Upholstered seats receive 1-1/2" thick HR-55, 2.8 density 55 ILD foam prior to being covered by a selected upholstery material that is wrapped around and stapled to the underside of the seat panel.

WOOD CHAIR BACKS

Chair backs are 5/8" thick bent multi-ply faced with select hardwood veneers. Adult backs: 6-1/2"H x 20-1/4"W. Youth backs: 5-7/8"H x 17-3/8"W.

DESIGN CUTOUTS

The wood chair backs only have a laser cutout design as selected by the customer. The inside edges of the cutout are blackened to provide a finished appearance.

UPHOLSTERY MATERIALS AND FABRICS

Brodart fabric selections and polyurethane foam are fire-rated.

Fabrics that meet Calif. Technical Bulletin #133 are available.

GLIDES

Each chair leg is equipped with a 7/8" diameter rubber-cushioned glide.

Catalog No.	Description	Seat H x W x D	Wt. (lbs.)	COM Price	Wood/G1 Price	Grade 2 Price	Grade 3 Price	Grade 4 Price	Grade 5 Price
All Wood Chair with Cutouts									
<i>All Wood Chair</i>									
77-571-S00	31-1/4"H Adult	18" x 20" x 19-5/8"	23		\$554				
77-561-S00	28-1/4"H Youth	16" x 16" x 17-1/4"	22		\$554				



Upholstered Seat Chair with Cutouts

Wood Frame Chair with Upholstered Seat

77-572-S00	31-1/4"H Adult	18" x 20" x 19-5/8"	23	\$655	\$648	\$734	\$760	\$946	\$1,001
77-562-S00	28-1/4"H Youth	16" x 16" x 17-1/4"	22	\$655	\$648	\$734	\$760	\$946	\$1,001

Fabric Requirements: 3/4 yard per chair, Non-directional, 54" wide.

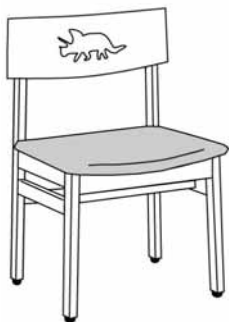

Please specify Wood Finish (Table 1) and Upholstery (Table 5). Details can be found on pages GEN 4 and GEN 5.

Note: Specify Cutout Design. Details can be found on page HOR 32.

General Specifications

CHAIR FRAME

The chair frame is constructed of 16-gauge steel tubing. All joints are mig-welded. The front and back legs are 1-3/4" diameter and the side and front stretchers are 1-1/2" x 3/4" rectangular tubing. The framing includes four metal brackets attaching the seat.

CHAIR SEAT

Chair seats are 5/8" thick bent multi-ply faced with maple.

UPHOLSTERED SEAT

Upholstered seats receive 1-1/2" thick HR-55, 2.8 density 55 ILD foam prior to being covered by a selected upholstery material that is wrapped around and stapled to the underside of the seat panel.

WOOD CHAIR BACKS

Chair backs are 5/8" thick bent multi-ply faced with maple. Adult backs: 10"H x 19-1/2"W. Youth backs: 8"H x 15-7/8"W.

DESIGN CUTOUTS

The wood chair backs only have a laser cutout design as selected by the customer. The inside edges of the cutout are blackened to provide a finished appearance.

UPHOLSTERY MATERIALS AND FABRICS

Brodart fabric selections and polyurethane foam are fire-rated. *Fabrics that meet Calif. Technical Bulletin #133 are available.*

BALL GLIDES

Each chair leg ends with a 2" diameter solid maple ball glide. The bottom of the ball glide has a surface of high-density polyethylene to protect the glide and floor.

Catalog No.	Description	Seat H x W x D	Wt. (lbs.)	COM Price	Wood/G1 Price	Grade 2 Price	Grade 3 Price	Grade 4 Price	Grade 5 Price
<u>Wood Seat and Back with Cutouts and Metal Frame Chair, Oak Wood</u>									
77A-571-S00 OAK	32-1/2"H Adult	18" x 20-1/4" x 17-1/2"	25		\$846				
77A-561-S00 OAK	28"H Youth	16" x 17-1/8" x 15"	25		\$846				
<u>Wood Seat and Back with Cutouts and Metal Frame Chair, Maple Wood</u>									
77A-571-S00 MAP	32-1/2"H Adult	18" x 20-1/4" x 17-1/2"	25		\$872				
77A-561-S00 MAP	28"H Youth	16" x 17-1/8" x 15"	25		\$872				

Wood Seat/Back Chair w/Cutouts



Upholstered and Wood Back with Cutouts and Metal Frame Chair, Oak Wood

77A-572-S00 OAK	32-1/2"H Adult	18" x 20-1/4" x 17-1/2"	25	\$954	\$947	\$1,079	\$1,108	\$1,383	\$1,463
77A-562-S00 OAK	28"H Youth	16" x 17-1/8" x 15"	25	\$902	\$897	\$1,010	\$1,045	\$1,309	\$1,384

Upholstered Seat Chair w/Cutouts

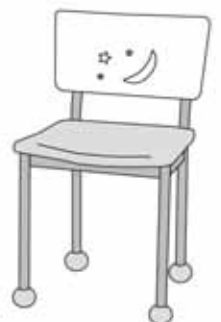

Upholstered and Wood Back with Cutouts and Metal Frame Chair, Maple Wood

77A-572-S00 MAP	32-1/2"H Adult	18" x 20-1/4" x 17-1/2"	25	\$983	\$976	\$1,112	\$1,142	\$1,425	\$1,506
77A-562-S00 MAP	28"H Youth	16" x 17-1/8" x 15"	25	\$929	\$924	\$1,041	\$1,076	\$1,348	\$1,427

Please specify Wood Finish (Table 1), Metal Color (Table 3) and Upholstery (Table 5). Details can be found on pages GEN 4 and GEN 5.

Note: Specify Cutout Design. Details can be found on page HOR 32.

General Specifications

CUTOUTS

The following standard cutouts are available at no charge. Cutouts must be specified for each product and each location on the furniture item. All cutouts are available in most positions on the furniture. Please contact Brodart for a cutout location page for each specific product you have interest in. Custom designs are available on a quote-per-design basis.

Note: The cutout size varies depending on location.

Dino's



Bird

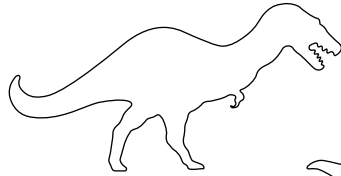

Tyranna

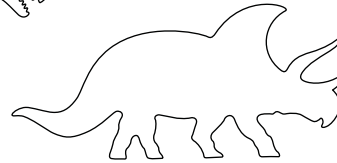

Tricera

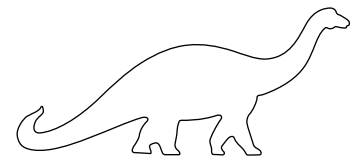

Bronto

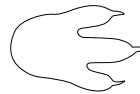

Dino Foot

Sports



Basketball

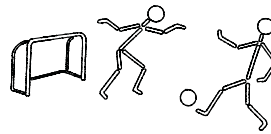

Soccer

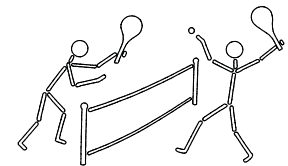

Tennis

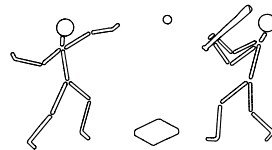

Baseball

Astronomy

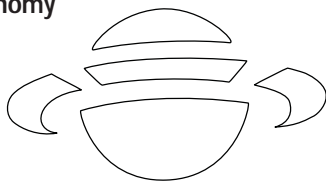

Saturn

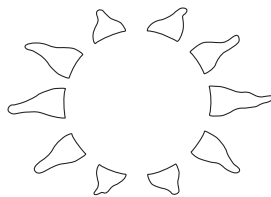

Sun



Shooting Star

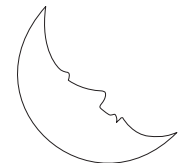

Moon



Stars



Moon and Stars

Note: Sizes shown are not to scale.

The Matrix Collection



2017 Price List and Specifications

Brodart Co. Contract Furniture - Made in USA

280 North Road, Clinton County Industrial Park • McElhattan, PA 17748

Toll-Free: 888-521-1884 • E-Mail: furniture@brodart.com • www.brodartfurniture.com

General Specifications

DESKTOP

Standard desktops are 1-3/16" thick, 45# density particleboard core, with a top surface of .050" thick, high-pressure laminate, with a backing sheet not less than .020" thick for balanced construction. High-pressure laminate has a lo-glare finish resistant to scratches, fading, and staining that meets or exceeds NEMA standards. Top receives a 5/8" thick, solid northern-grown white maple edge band on the patron side, and it is of a straight design with a 1/4" radius on the top and bottom edges. The remaining three edges receive a 1/4" solid white maple band with 1/8" radius. All four edges are externally banded being applied after the laminate and backing. The top sits flush with the unit's ends and back side and overhangs 2-1/2" at the front side. (See band variation on adjustable or set in work surfaces.)

END PANELS

Desk module end panels are 1" thick, 45# density particleboard core with grade A-A plain-sliced northern grown white maple veneers, slip-matched on both faces. The four edges are banded with matching maple wood banding. The end panels and front panel are joined together with 3/4" x 3/4" cleats and screws. The bottom of each end receives two adjustable leveling glides. Each end also has a 3" diameter grommet hole for power and data cord passage.

DETACHABLE END PANELS

Detachable end panels are 1" thick, 45# density particleboard core with grade A-A plain-sliced northern grown white maple veneers, slip-matched on both faces. The four edges are banded with matching maple wood banding. The decorative end panel has four bolting holes to attach at the end of a range of desk units. These detachable end panels are offered as a pair. The outside face on the panels receive a series of black 1/2" design squares, two rows of ten squares and one row of nine squares. The design pattern of squares is centered left to right and begins 3-3/4" down from the top edge of the panel.

FRONT PANELS

The front panel is 3/4" thick, 45# density particleboard core with Grade A-A plain-sliced, northern-grown white maple veneers, slip-matched on both faces. The edges are banded with matching white maple wood. Connected to the bottom area of the front is a 6"H x 3/4"D recessed, ebonized kick plate. The front panel is positioned over the front edges of the end panels of the desk module, flush with the outside edges of the desk unit. Double-wide units have two front panels to maintain the uniform look of 35"W units for aesthetic purposes. The front panels of all units receive a series of black 1/2" design squares to form a design pattern. Single-wide units receive two rows of 14 squares and one row of 13 squares. Double-wide units receive twice as many squares. The design pattern of squares is centered left to right and begins 3-3/4" down from the top edge of each front. All corner units receive a matching design pattern of 1/2" black squares.

ADJUSTABLE WORK SURFACE (Available on limited units)

Work surfaces are 1-3/16" thick, 45# density particleboard core, including a top surface of .050" thick, high-pressure laminate with a backing sheet not less than .020" thick for balanced construction. Plastic laminate has a lo-glare finish resistant to scratches, fading, and staining that meets or exceeds NEMA standards. The exposed edge at the rear of the desk receives a 1/4" thick, maple internal edge band in straight design with a 1/4" radius on the top and bottom edges. Available in standing height unit only and adjustable to 36", 32" and 27"H.

SHELVES

Shelves are constructed of plywood with matching wood veneers, the front edge receive a matching maple wood band.

DRAWERS

Drawers are constructed of solid hardwood with 1/4" thick plywood bottom panel. Fronts are 3/4" thick with matching maple veneer faces and banded edges. Box drawers have 3/4" full extension metal slides, and file drawers have full extension metal slides; each are 100 lb. load capacity.

ELECTRICAL

See Brodart optional electrical accessories for electrical power distribution and wire management components.

DESK DIMENSIONS

Standing-Height Desk, Overall:

Single Units: 39-3/16"H x 35"W x 30"D

Double Units: 39-3/16"H x 70"W x 30"D

Sitting-Height Desk, Overall:

Single Units: 32-3/16"H x 35"W x 30"D

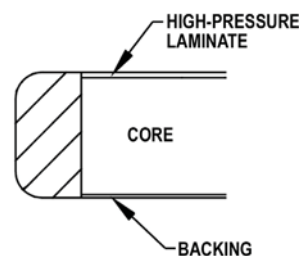

Double Units: 32-3/16"H x 70"W x 30"D



Matrix Series Flush Edge

Oak Catalog No.	Maple Catalog No.	Description	H x W x D	Wt. (lbs.)	Oak Price	Maple Price	Standing	Sitting
93-012-S00 OAK	93-012-S00 MAP	Standing Height Desk with Patron Service Ledge Inside dimensions: 33"W x 26-3/4"D. The 7-7/8" patron ledge is at a height of 39-3/16"H. Note: Adjustable-height work surface may be positioned at heights of 36", 32" or 27".	39-3/16" x 35" x 30"	140	\$2,868	\$3,126	Single-Wide Desk with Patron Service Ledge	
93-E12-S00 OAK	93-E12-S00 MAP	Sitting Height Desk with Patron Service Ledge Inside dimensions: 33"W x 26-3/4"D. The 7-7/8" patron ledge is at a height of 32-3/16"H. Note: Work surface is fixed at 27"H.	32-3/16" x 35" x 30"	125	\$2,730	\$2,976	Single-Wide Desk with Patron Service Ledge	
93-014-S00 OAK	93-014-S00 MAP	Standing Height Desk without Patron Service Ledge Inside dimensions: 33"W x 26-3/4"D. The work surface is at 39-3/16"H. Two 3" diameter grommets are located in the work surface.	39-3/16" x 35" x 30"	135	\$2,518	\$2,745	Single-Wide Desk without Patron Service Ledge	
93-E14-S00 OAK	93-E14-S00 MAP	Sitting Height Desk without Patron Service Ledge Inside dimensions: 33"W x 26-3/4"D. The work surface is at 32-3/16"H. Two 3" diameter grommets are located in the work surface.	32-3/16" x 35" x 30"	120	\$2,273	\$2,477	Single-Wide Desk without Patron Service Ledge	
93-015-S00 OAK	93-015-S00 MAP	Standing Height Book Return Unit Inside dimensions: 33"W x 26-3/4"D. The work surface is at 39-3/16"H. Unit has a 5"H x 12"W finished opening centered in the front panel for passage of books and a book chute to direct the books over a mobile depressible book truck. (Depressible book truck not included). Two 3" diameter grommets are located in the work surface.	39-3/16" x 35" x 30"	135	\$2,446	\$2,665	Book Return Unit	
93-E15-S00 OAK	93-E15-S00 MAP	Sitting Height Book Return Unit Inside dimensions: 33"W x 26-3/4"D. The work surface is at 32-3/16"H. Unit has a 5"H x 12"W finished opening centered in the front panel for passage of books and a book chute to direct the books over a mobile depressible book truck. (Depressible book truck not included). Two 3" diameter grommets are located in the work surface.	32-3/16" x 35" x 30"	120	\$2,309	\$2,516	Book Return Unit	

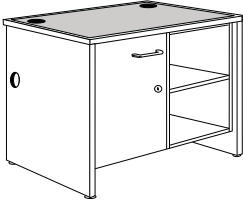
Please specify Wood Finish (Table 1) and High-Pressure Laminate (Table 2). Details can be found on page GEN 4.

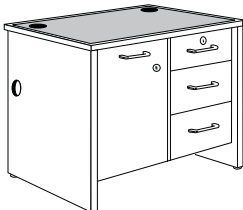
Standing	Sitting	Oak Catalog No.	Maple Catalog No.	Description	H x W x D	Wt. (lbs.)	Oak Price	Maple Price
Cupboard and Open Shelf		93-121-S00 OAK	93-121-S00 MAP	Standing Height Cupboard and Open Shelf This unit has one fixed and two adjustable shelves. A hidden drawer is positioned above the lockable storage compartment. Two 3" diameter grommets are located in the work surface.	39-3/16" x 35" x 30"	175	\$4,684	\$5,106
		93-E21-S00 OAK	93-E21-S00 MAP	Sitting Height Cupboard This unit has one fixed and one adjustable shelf. A hidden drawer is positioned above the lockable storage compartment. Two 3" diameter grommets are located in the work surface.	32-3/16" x 35" x 30"	160	\$4,389	\$4,784
								
Full Width Drawer, Cupboard and Drawers		93-122-S00 OAK	93-122-S00 MAP	Standing Height Full Width Drawer, Cupboard and Drawers This unit has one full-width drawer, two file drawers, and a lockable storage compartment. Two 3" diameter grommets are located in the work surface. Note: Available in 39"H only.	39-3/16" x 35" x 30"	225	\$6,371	\$6,944
								
Cupboard and Drawer Unit		93-123-S00 OAK	93-123-S00 MAP	Standing Height Cupboard and Drawer Unit This unit has one locking box drawer and two file drawers. Cupboard section has two adjustable shelves and locking door on hinges. Two 3" diameter grommets are located in the work surface.	39-3/16" x 35" x 30"	225	\$5,656	\$6,165
		93-E23-S00 OAK	93-E23-S00 MAP	Sitting Height Cupboard and Drawer Unit This unit has one locking file drawer and one file drawer. Cupboard section has one adjustable shelf and locking door on hinges. Two 3" diameter grommets are located in the work surface.	32-3/16" x 35" x 30"	205	\$5,161	\$5,625
								

Please specify Wood Finish (Table 1) and High-Pressure Laminate (Table 2). Details can be found on page GEN 4.

Oak Catalog No.	Maple Catalog No.	Description	H x W x D	Wt. (lbs.)	Oak Price	Maple Price	Standing	Sitting
93-124-S00 OAK	93-124-S00 MAP	<p>Standing Height Open Shelf and Drawer Unit</p> <p>This unit has one lockable box drawer and two file drawers. Shelf section has two adjustable shelves, and one fixed base shelf. Two 3" diameter grommets are located in the work surface.</p>	39-3/16" x 35" x 30"	200	\$5,231	\$5,702	Open Shelf and Drawer Unit	
93-E24-S00 OAK	93-E24-S00 MAP	<p>Sitting Height Open Shelf and Drawer Unit</p> <p>This unit has one lockable box drawer and one file drawer. Shelf section has one adjustable shelf, and one fixed base shelf. Two 3" diameter grommets are located in the work surface.</p>	32-3/16" x 35" x 30"	125	\$4,809	\$5,242	Open Shelf and Drawer Unit	
93-131-S00 OAK	93-131-S00 MAP	<p>Standing Height Cash Drawer Unit</p> <p>Inside dimensions: 33"W x 26-3/4"D. The work surface is at 39-3/16"H. Desk has locking drawer with a coin and currency tray. Two 3" diameter grommets are located in the work surface.</p>	39-3/16" x 35" x 30"	150	\$3,596	\$3,920	Cash Drawer Unit	
93-E31-S00 OAK	93-E31-S00 MAP	<p>Sitting Height Cash Drawer Unit</p> <p>Inside dimensions: 33"W x 26-3/4"D. The work surface is at 32-3/16"H. Desk has locking drawer with a coin and currency tray. Two 3" diameter grommets are located in the work surface.</p>	32-3/16" x 35" x 30"	135	\$3,447	\$3,758	Cash Drawer Unit	
93-E32-S00 OAK	93-E32-S00 MAP	<p>Sitting Height ADA Station</p> <p>The ADA transaction station is designed to provide wheelchair access on the patrons' side. The knee space depth on the patrons' side is 22-1/4" and on the staff side is 16". Two 3" diameter grommets are located in the work surface. One 3-1/2" diameter egress with sleeve is located in each end panel for wire passage.</p>	32-3/16" x 35" x 40-1/2"	185	\$2,730	\$2,976	ADA Station	

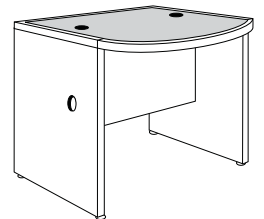
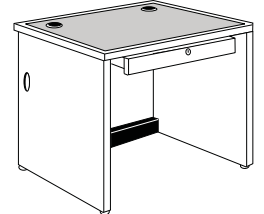
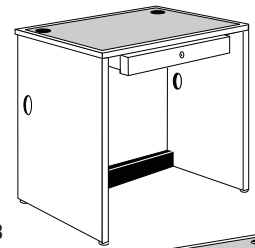
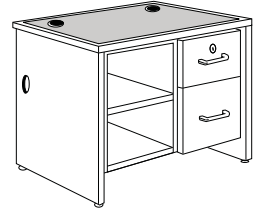

Please specify Wood Finish (Table 1) and High-Pressure Laminate (Table 2). Details can be found on page GEN 4.

Standing	Sitting	Oak Catalog No.	Maple Catalog No.	Description	H x W x D	Wt. (lbs.)	Oak Price	Maple Price
		93-133-S00 OAK	93-133-S00 MAP	Standing Height Full Width Drawer Unit	39-3/16" x 35" x 30"	160	\$3,693	\$4,025



This drawer unit has a full-width drawer 10"H x 33"W x 18-3/4"D. Two 3" diameter grommets are located in the work surface.
Note: Available in 39" H only.

		93-135-S00 OAK	93-135-S00 MAP	Standing Height Full Width Drawer and Cupboard Unit	39-3/16" x 35" x 30"	220	\$4,092	\$4,460
--	--	----------------	----------------	--	----------------------	-----	---------	---------



This unit has a full-width drawer 10"H x 33"W x 18-3/4"D. Also, one fixed and one adjustable, full-depth shelf. Hinged doors have a catch, lock and door pulls. Two 3" diameter grommets are located in the work surface.

		93-172-S00 OAK	93-172-S00 MAP	Standing Height Discharge Unit	39-3/16" x 35" x 30"	165	\$3,854	\$4,201
--	--	----------------	----------------	--------------------------------	----------------------	-----	---------	---------

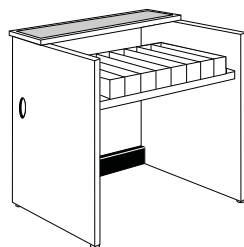

These units have a full-width well with seven removable wood trays for 5"H x 3"W cards. The 7-7/8" patron ledge is at a height of 39-3/16"H.
Note: Standing-height roll unders do not work with this unit.

		93-E72-S00 OAK	93-E72-S00 MAP	Sitting Height Discharge Unit	32-3/16" x 35" x 30"	145	\$3,655	\$3,984
--	--	----------------	----------------	-------------------------------	----------------------	-----	---------	---------

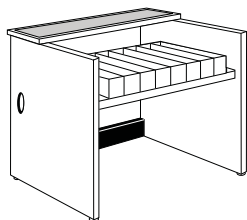

These units have a full-width well with seven removable wood trays for 5"H x 3"W cards. The 7-7/8" patron ledge is at a height of 32-3/16"H.

Please specify Wood Finish (Table 1) and High-Pressure Laminate (Table 2). Details can be found on page GEN 4.

Oak Catalog No.	Maple Catalog No.	Description	H x W x D	Wt. (lbs.)	Oak Price	Maple Price	Standing	Sitting
93-174-S00 OAK	93-174-S00 MAP	Standing Height Open Shelf Unit This unit has a full-depth fixed base shelf and two full-depth adjustable shelves. Two 3" diameter grommets are located in the work surface.	39-3/16" x 35" x 30"	175	\$2,904	\$3,165		Open Shelf Unit
93-E74-S00 OAK	93-E74-S00 MAP	Sitting Height Open Shelf Unit This unit has a full-depth fixed base shelf and two full-depth adjustable shelves. Two 3" diameter grommets are located in the work surface.	32-3/16" x 35" x 30"	155	\$2,605	\$2,839		
93-176-S00 OAK	93-176-S00 MAP	Standing Height Cupboard Unit This unit has a full-depth fixed base shelf and two full-depth adjustable shelves. Hinged doors have a catch, lock and door pulls. Two 3" diameter grommets are located in the work surface.	39-3/16" x 35" x 30"	200	\$3,575	\$3,896		Cupboard Unit
93-E76-S00 OAK	93-E76-S00 MAP	Sitting Height Cupboard Unit This unit has a full-depth fixed base shelf and one full-depth adjustable shelf. Hinged doors have a catch, lock and door pulls. Two 3" diameter grommets are located in the work surface.	32-3/16" x 35" x 30"	180	\$3,418	\$3,726		
93-234-S00 OAK	93-234-S00 MAP	Standing Height Full Width Drawer and Open Shelves This unit has a full-width drawer 10"H x 33"W x 18-3/4"D. Also, one fixed and one adjustable, full-depth shelf. Two 3" diameter grommets are located in the work surface.	39-3/16" x 35" x 30"	180	\$3,498	\$3,813		Full Width Drawer and Open Shelves
93-E34-S00 OAK	93-E34-S00 MAP	Sitting Height Full Width Drawer and Open Shelves This unit has a full-width drawer 10"H x 33"W x 18-3/4"D. Also, one fixed and one adjustable, full-depth shelf. Two 3" diameter grommets are located in the work surface.	32-3/16" x 35" x 30"	165	\$3,300	\$3,597		

Please specify Wood Finish (Table 1) and High-Pressure Laminate (Table 2). Details can be found on page GEN 4.

Standing	Sitting	Oak Catalog No.	Maple Catalog No.	Description	H x W x D	Wt. (lbs.)	Oak Price	Maple Price
		93-236-S00 OAK	93-236-S00 MAP	Standing Height Media Storage Unit This unit has four full-width drawers 8-1/2"H x 33"W x 24"D with each containing five compartments for media storage.	39-3/16" x 35" x 30"	225	\$4,984	\$5,433
		93-E36-S00 OAK	93-E36-S00 MAP	Sitting Height Media Storage Unit This unit has three full-width drawers 8-1/2"H x 33"W x 24"D with each containing five compartments for media storage.	32-3/16" x 35" x 30"	205	\$4,620	\$5,036

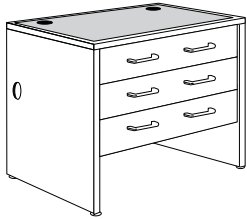
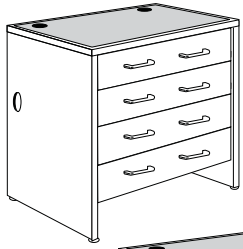

Please specify Wood Finish (Table 1) and High-Pressure Laminate (Table 2). Details can be found on page GEN 4.

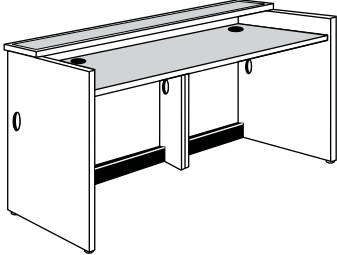
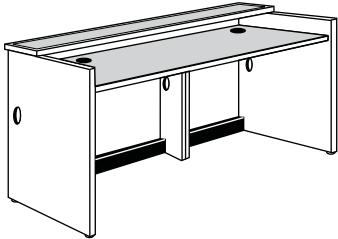
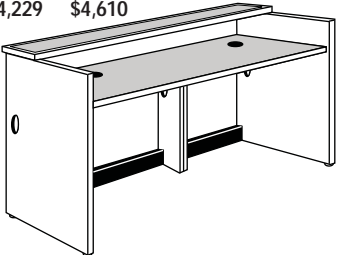
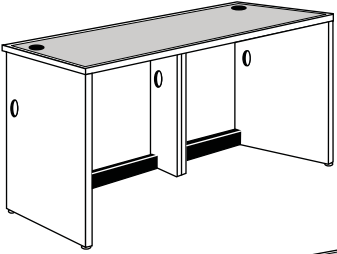
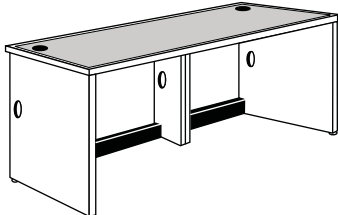
Oak Catalog No.	Maple Catalog No.	Description	H x W x D	Wt. (lbs.)	Oak Price	Maple Price	Standing	Sitting
93-011-S00 OAK	93-011-S00 MAP	Standing Height Double-Wide Desk with Patron Service Ledge Work Surface at 35"H Inside dimensions are 68"W x 26-3/4"D. The 7-7/8"D patron ledge is at a height of 39-3/16". Two 3" diameter grommets are located in the work surface. Note: Standing-height roll unders do not work with this unit.	39-3/16" x 70" x 30"	245	\$4,218	\$4,598		Double-Wide Desk with Patron Service Ledge,
								
93-E11-S00 OAK	93-E11-S00 MAP	Sitting Height Double-Wide Desk with Patron Service Ledge Work Surface at 28"H Inside dimensions are 68"W x 26-3/4"D. The 7-7/8"D patron ledge is at a height of 32-3/16". Two 3" diameter grommets are located in the work surface.	32-3/16" x 70" x 30"	210	\$3,992	\$4,351		
								
93-011-SEA OAK	93-011-SEA MAP	Standing Height Double-Wide Desk with Patron Service Ledge Work Surface at 28"H Inside dimensions are 68"W x 26-3/4"D. The 7-7/8"D patron ledge is at a height of 39-3/16". Two 3" diameter grommets are located in the work surface. Note: Standing-height roll unders do not work with this unit.	39-3/16" x 70" x 30"	245	\$4,229	\$4,610		
								
93-013-S00 OAK	93-013-S00 MAP	Standing Height Double-Wide Desk without Patron Service Ledge Inside dimensions are 68"W x 26-3/4"D. The work surface is at 39-3/16" H. Two 3" diameter grommets are located in the work surface.	39-3/16" x 70" x 30"	230	\$3,777	\$4,116		Double-Wide Desk without Patron Service Ledge
								
93-E13-S00 OAK	93-E13-S00 MAP	Sitting Height Double-Wide Desk without Patron Service Ledge Inside dimensions are 68"W x 26-3/4"D. The work surface is at 32-3/16" H. Two 3" diameter grommets are located in the work surface.	32-3/16" x 70" x 30"	195	\$3,601	\$3,925		
								

Please specify Wood Finish (Table 1) and High-Pressure Laminate (Table 2). Details can be found on page GEN 4.

Standing	Sitting	Oak Catalog No.	Maple Catalog No.	Description	H x W x D	Wt. (lbs.)	Oak Price	Maple Price
Double-Wide Work Desk	Double Pedestal	93-E37-S00 OAK	93-E37-S00 MAP	Sitting Height Double-Wide Double Pedestal Work Desk Inside dimensions are 68"W x 26-3/4"D. This unit has two drawer pedestals, one mounted on each side consisting of one locking drawer at top; one file drawer with hanging file rack at bottom. Two center drawers are mounted between the two pedestals. Two 3" diameter grommets are located in the work surface. Note: Available in 32-3/16" H only.	32-3/16" x 70" x 30"	260	\$8,380	\$9,134
Double-Wide Work Desk	Single Pedestal	93-238-S00 OAK	93-238-S00 MAP	Standing Height Double-Wide Single Pedestal Work Desk Inside dimensions are 68"W x 26-3/4"D. This unit has one drawer pedestal mounted on the left side consisting of one locking drawer at top; two file drawers with Pendaflex hangers at the bottom. Two 3" diameter grommets are located in the work surface.	39-3/16" x 70" x 30"	230	\$5,606	\$6,110
	Single Pedestal	93-E38-S00 OAK	93-E38-S00 MAP	Sitting Height Double-Wide Single Pedestal Work Desk Inside dimensions are 68"W x 26-3/4"D. This unit has one drawer pedestal mounted on the left side consisting of one locking file drawer at top; one file drawer at the bottom, both with hanging file racks. Two 3" diameter grommets are located in the work surface.	32-3/16" x 70" x 30"	195	\$5,310	\$5,788

Please specify Wood Finish (Table 1) and High-Pressure Laminate (Table 2). Details can be found on page GEN 4.

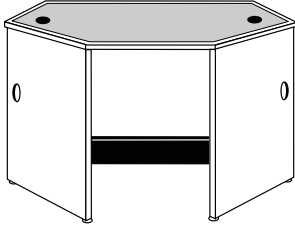
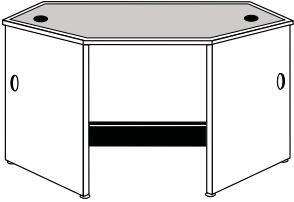
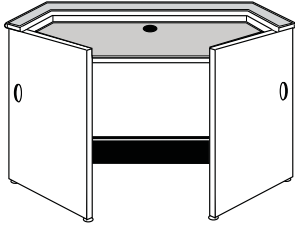
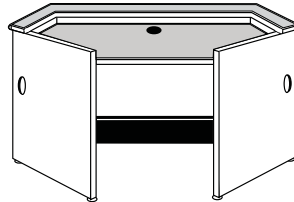
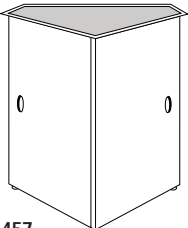
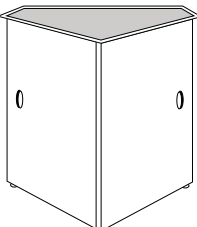
Oak Catalog No.	Maple Catalog No.	Description	H x W x D	Wt. (lbs.)	Oak Price	Maple Price	Standing	Sitting
93-010-S00 OAK	93-010-S00 MAP	Standing Height 90 Degree Multi-Purpose Corner Unit has 29-5/16" W port area. Storage shelves are located in the two angled areas to the left and right of the desk module. One 3" diameter grommet is located in the work-surface top. One 3-1/2" diameter egress with sleeve is located in each end panel for wire passage.	39-3/16" x 71-3/4" x 30"	250	\$7,143	\$7,786		90 Degree Multi-Purpose Corner
								
93-E10-S00 OAK	93-E10-S00 MAP	Sitting Height 90 Degree Multi-Purpose Corner Unit has 29-5/16" W port area. Storage shelves are located in the two angled areas to the left and right of the desk module. One 3" diameter grommet is located in the work-surface top. One 3-1/2" diameter egress with sleeve is located in each end panel for wire passage.	32-3/16" x 71-3/4" x 30"	215	\$6,801	\$7,413		
								
93-017-S00 OAK	93-017-S00 MAP	Standing Height 90 Degree Multi-Purpose with Patron Service Ledge Unit has 29-5/16" W port area. The 7-7/8" D patron ledge is at a height of 39-3/16". Work surface is at 35"H. Storage shelves are located in the two angled areas to the left and right of the module. One 3" diameter grommet is located in the work surface top. One 3-1/2" diameter egress with sleeve is located in each end panel for wire passage.	39-3/16" x 71-3/4" x 30"	245	\$9,461	\$10,312		90 Degree Multi-Purpose Corner with Patron Service Ledge
								
93-E17-S00 OAK	93-E17-S00 MAP	Sitting Height 90 Degree Multi-Purpose with Patron Service Ledge Unit has 29-5/16" W port area. The 7-7/8" D patron ledge is at a height of 32-3/16". Work surface is at 28"H. Storage shelves are located in the two angled areas to the left and right of the module. One 3" diameter grommet is located in the work surface top. One 3-1/2" diameter egress with sleeve is located in each end panel for wire passage.	32-3/16" x 71-3/4" x 30"	210	\$9,001	\$9,811		
								
93-016-S00 OAK	93-016-S00 MAP	Standing Height 90 Degree Closed Corner Unit This 90 degree unit is used to form a right angle turn in a desk arrangement. This is not available with patron ledge. One 3-1/2" diameter egress is located in each end panel for wire passage through a continuous ABS tube.	39-3/16" H	140	\$3,333	\$3,633		90 Degree Closed Corner Unit
								
93-E16-S00 OAK	93-E16-S00 MAP	Sitting Height 90 Degree Closed Corner Unit This 90 degree unit is used to form a right angle turn in a desk arrangement. This is not available with patron ledge. One 3-1/2" diameter egress is located in each end panel for wire passage through a continuous ABS tube.	32-3/16" H	120	\$3,172	\$3,457		
								

Please specify Wood Finish (Table 1) and High-Pressure Laminate (Table 2). Details can be found on page GEN 4.

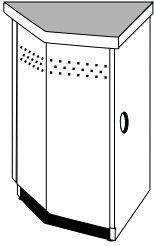
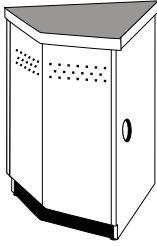
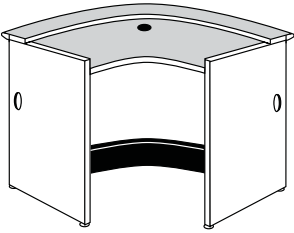
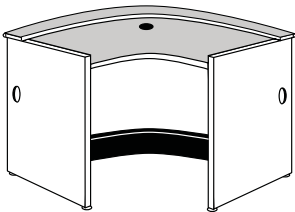
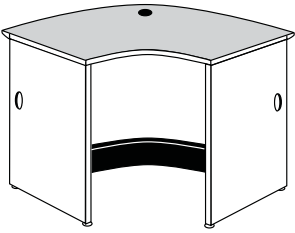
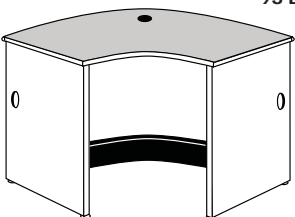
Standing	Sitting	Oak Catalog No.	Maple Catalog No.	Description	H x W x D	Wt. (lbs.)	Oak Price	Maple Price
45 Degree Closed Corner Unit		93-018-S00 OAK	93-018-S00 MAP	Standing Height 45 Degree Closed Corner Unit	39-3/16" x 22-7/8" x 30"	130	\$3,333	\$3,633
				This corner unit is used to create a 45 degree angle in the circulation desk. This unit is not available with a patron ledge.				
		93-E18-S00 OAK	93-E18-S00 MAP	Sitting Height 45 Degree Closed Corner Unit	32-3/16" x 22-7/8" x 30"	110	\$3,172	\$3,457
				This corner unit is used to create a 45 degree angle in the circulation desk. This unit is not available with a patron ledge.				
90 Degree Open Curved Corner with Patron Service Ledge		93-040-S00 OAK	93-040-S00 MAP	Standing Height 90 Degree Open Curved Corner with Patron Service Ledge	39-3/16" x 70-1/8" x 30"	245	\$10,560	\$11,510
				The 7-7/8" D patron ledge is at a height of 39-3/16". The work surface is at 35"H. Unit has 26-5/8"W port area. Storage shelves are located in the two angled areas to the left and right of the desk module. One 3" diameter grommet is located in the work surface top. One 3-12" diameter egress with sleeve is located in each end panel for wire passage.				
		93-E40-S00 OAK	93-E40-S00 MAP	Sitting Height 90 Degree Open Curved Corner with Patron Service Ledge	32-3/16" x 70-1/8" x 30"	210	\$10,045	\$10,949
				The 7-7/8" D patron ledge is at a height of 32-3/16". The work surface is at 35"H. Unit has 26-5/8"W port area. Storage shelves are located in the two angled areas to the left and right of the desk module. One 3" diameter grommet is located in the work surface top. One 3-12" diameter egress with sleeve is located in each end panel for wire passage.				
90 Degree Open Curved Corner		93-041-S00 OAK	93-041-S00 MAP	Standing Height 90 Degree Open Curved Corner	39-3/16" x 70-1/8" x 30"	245	\$9,160	\$9,984
				Work surface is at 39-3/16"H. Unit has 26-5/8"W port area. Storage shelves are located in the two angled areas to the left and right of the desk module. One 3" diameter grommet is located in the work-surface top. One 3-1/2" diameter egress with sleeve is located in each end panel for wire passage.				
		93-E41-S00 OAK	93-E41-S00 MAP	Sitting Height 90 Degree Open Curved Corner	32-3/16" x 70-1/8" x 30"	210	\$8,720	\$9,505
				Work surface is at 32-3/16"H. Unit has 26-5/8"W port area. Storage shelves are located in the two angled areas to the left and right of the desk module. One 3" diameter grommet is located in the work-surface top. One 3-1/2" diameter egress with sleeve is located in each end panel for wire passage.				

Please specify Wood Finish (Table 1) and High-Pressure Laminate (Table 2). Details can be found on page GEN 4.

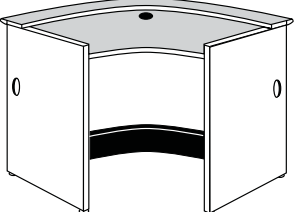
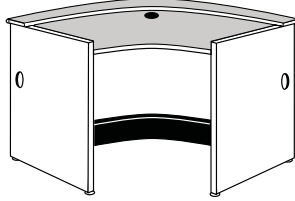
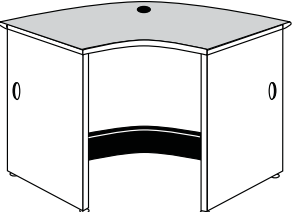
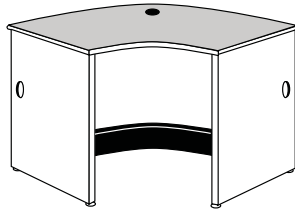
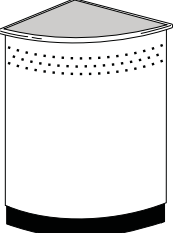
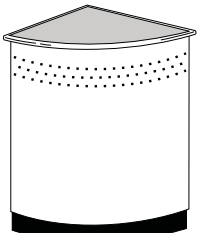
Oak Catalog No.	Maple Catalog No.	Description	H x W x D	Wt. (lbs.)	Oak Price	Maple Price	Standing	Sitting
93-047-S00 OAK	93-047-S00 MAP	Standing Height 60 Degree Curved Corner with Patron Service Ledge The 7-7/8"D patron ledge is at a height of 39-3/16". The work surface is at 35-7/16"H. Unit has 49-1/16" W port area. Storage shelves are located in the two angled areas to the left and right of the desk module. One 3" diameter grommet is located in the work surface top. One 3-1/2" diameter egress with sleeve is located in each end panel for wire passage.	39-3/16" x 80-3/4" x 30"	245	\$12,787	\$13,938	60 Degree Curved Corner with Patron Service Ledge	
								
93-E47-S00 OAK	93-E47-S00 MAP	Sitting Height 60 Degree Curved Corner with Patron Service Ledge The 7-7/8"D patron ledge is at a height of 32-3/16". The work surface is at 28"H. Unit has 49-1/16" W port area. Storage shelves are located in the two angled areas to the left and right of the desk module. One 3" diameter grommet is located in the work surface top. One 3-1/2" diameter egress with sleeve is located in each end panel for wire passage.	32-3/16" x 80-3/4" x 30"	210	\$12,161	\$13,255		
								
93-048-S00 OAK	93-048-S00 MAP	Standing Height 60 Degree Curved Corner Work surface is at 39-3/16"H. Unit has 49-1/16"W port area. Storage shelves are located in the two angled areas to the left and right of the desk module. One 3" diameter grommet is located in the work surface top. One 3-1/2" diameter egress with sleeve is located in each end panel for wire passage.	39-3/16" x 80-3/4" x 30"	245	\$11,391	\$12,416	60 Degree Curved Corner	
								
93-E48-S00 OAK	93-E48-S00 MAP	Sitting Height 60 Degree Curved Corner Work surface is at 32-3/16"H. Unit has 49-1/16"W port area. Storage shelves are located in the two angled areas to the left and right of the desk module. One 3" diameter grommet is located in the work surface top. One 3-1/2" diameter egress with sleeve is located in each end panel for wire passage.	32-3/16" x 80-3/4" x 30"	210	\$10,853	\$11,830		
								
93-055-S00 OAK	93-055-S00 MAP	Standing Height 90 Degree Closed Corner Unit This 90 degree unit is used to form a right-angle turn in a desk arrangement. This unit is provided with a curved front panel.	39-3/16"H x 30"D	140	\$3,985	\$4,344	90 Degree Curved Closed Corner Unit	
								
93-E55-S00 OAK	93-E55-S00 MAP	Sitting Height 90 Degree Closed Corner Unit This 90 degree unit is used to form a right-angle turn in a desk arrangement. This unit is provided with a curved front panel.	32-3/16"H x 30"D	120	\$3,614	\$3,940		
								

Please specify Wood Finish (Table 1) and High-Pressure Laminate (Table 2). Details can be found on page GEN 4.

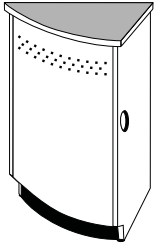
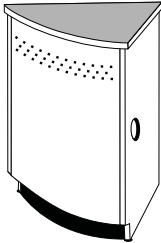
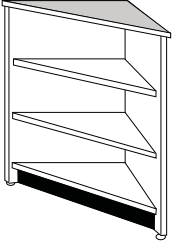
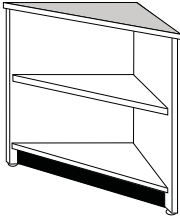
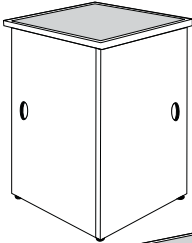
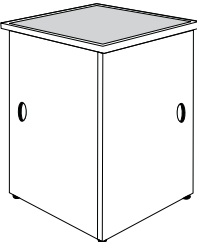
Standing	Sitting	Oak Catalog No.	Maple Catalog No.	Description	H x W x D	Wt. (lbs.)	Oak Price	Maple Price
45 Degree Curved Closed Corner Unit		93-058-S00 OAK	93-058-S00 MAP	Standing Height 45 Degree Curved Closed Corner Unit This unit is used to create a 45 degree angle in the circulation desk. It is not available with patron ledge.	39-3/16" x 22-3/8" x 30"	130	\$3,985	\$4,344
		93-E58-S00 OAK	93-E58-S00 MAP	Sitting Height 45 Degree Curved Closed Corner Unit This unit is used to create a 45 degree angle in the circulation desk. It is not available with patron ledge.	32-3/16" x 22-3/8" x 30"	110	\$3,614	\$3,940
90 Degree Open Corner Shelf		93-143-S00 OAK	93-143-S00 MAP	Standing Height 90 Degree Open Corner Shelf This 90 degree unit is used to form a right-angle turn in a desk arrangement. Has one fixed base shelf and two adjustable shelves. Note: Units must be modified on a project by project basis for electrical pass-through on open corner units.	39-3/16"H x 30"D	140	\$3,498	\$3,813
		93-E43-S00 OAK	93-E43-S00 MAP	Sitting Height 90 Degree Open Corner Shelf This 90 degree unit is used to form a right-angle turn in a desk arrangement. Has one base shelf and two adjustable shelves. Note: Units must be modified on a project by project basis for electrical pass-through on open corner units.	32-3/16"H x 30"D	120	\$3,348	\$3,650
90 Degree Square Corner Unit		93-150-S00 OAK	93-150-S00 MAP	Standing Height 90 Degree Square Corner Unit This square corner unit is used to form a right angle in a desk arrangement. One 3" diameter egress is located in each end panel for wire passage through a continuous ABS tube.	39-3/16" x 30" x 30"	160	\$3,820	\$4,164
		93-E50-S00 OAK	93-E50-S00 MAP	Sitting Height 90 Degree Square Corner Unit This square corner unit is used to form a right angle in a desk arrangement. One 3" diameter egress is located in each end panel for wire passage through a continuous ABS tube.	32-3/16" x 30" x 30"	140	\$3,477	\$3,789

Please specify Wood Finish (Table 1) and High-Pressure Laminate (Table 2). Details can be found on page GEN 4.

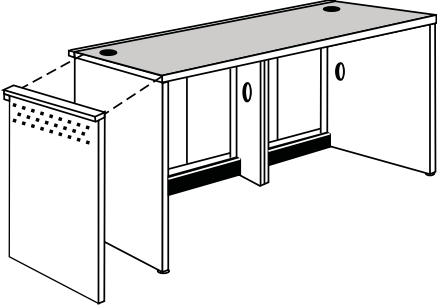
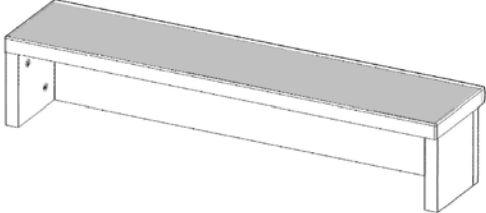
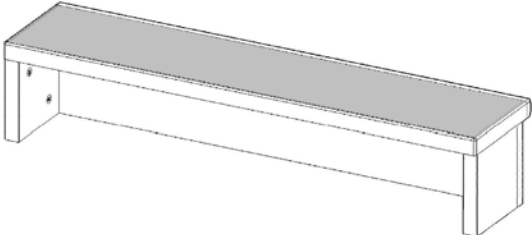
Oak Catalog No.	Maple Catalog No.	Description	H x W x D	Wt. (lbs.)	Oak Price	Maple Price	
93-178-S00 OAK	93-178-S00 MAP	Detachable End Panels (Pair) End panels are 1" thick, 3-ply, 45# density particleboard core with plain-sliced oak or maple veneers. Exposed edges are externally banded with 1.6mm thick, solid Northern-grown Oak or maple edge band.	37-1/2" x 1" x 26-3/4"	52	\$1,315	\$1,433	Detachable End Panels (Pair) 
93-E78-S00 OAK	93-E78-S00 MAP	Detachable End Panels (Pair) End panels are 1" thick, 3-ply, 45# density particleboard core with plain-sliced oak or maple veneers. Exposed edges are externally banded with 1.6mm thick, solid Northern-grown Oak or maple edge band.	30-1/2" x 1" x 26-3/4"	42	\$1,267	\$1,381	
93-196-S00 OAK	93-196-S00 MAP	Single-Wide Add On 7"H Patron Ledge Unit is designed to be added onto a single wide desk without a patron ledge. The Patron Ledge Assembly will attach to the desktop by means of #8 x 2-1/2" screws inserted through the work surface into the ledge assembly.	7" x 35" x 7-7/8"	10	\$526	\$574	Single-Wide Add On 7"H Patron Ledge 
93-197-S00 OAK	93-197-S00 MAP	Double-Wide Add On 7"H Patron Ledge Unit is designed to be added onto a double wide desk without a patron ledge. The Patron Ledge Assembly will attach to the desktop by means of #8 x 2-1/2" screws inserted through the work surface into the ledge assembly.	7" x 70" x 7-7/8"	20	\$665	\$725	Double-Wide Add On 7"H Patron Ledge 

Please specify Wood Finish (Table 1) and High-Pressure Laminate (Table 2). Details can be found on page GEN 4.

General Specifications

TABLETOP

Standard tabletops are 1-3/16" thick, a plywood core or 3-ply particleboard core, as specified, including a top surface of .050" thick, high-pressure laminate, with a backing sheet not less than .020" thick for balanced construction, unless the top is over 72" long in which case it is .050" thick to prevent warping. High-pressure laminate has a lo-glare finish resistant to scratches, fading, and staining that meets or exceeds NEMA standards. Edges are white hardrock maple. This edge band is 5/8" thick x 1-5/8"W and is applied to the core after the top and bottom laminate sheets are applied making it an external edge. This wood edge band is rectangular in design with a 1/4" radius on the top and bottom front edges. The four tabletop corners are eased.

LEGS

Legs are round with compound tapers. The leg is 3-1/2" diameter at the top and 2-1/2" diameter 8" down from the top. At the bottom of the leg the diameter is 1-7/8". 8" down from the top of the leg is a vein-line 1/8"D x 1/8"W. The leg is one piece solid maple. The bottom of the leg has an 1/8" chamfer and an adjustable, leveling floor glide. The legs attach to the underside of the tabletop by means of a 5" square x 5/16" thick steel plate. The plate is attached to the leg by a 5/16" x 2-1/2" long machine bolt engaging a 5/8" diameter barrel nut inserted into the leg. The steel plate is attached to the tabletop by five 5/16"-18 x 1" long machine screws engaging internally and externally threaded bushings in the underside of the tabletop. Leg plates are positioned behind, and hidden by, the extended table edge band.

TABLETOP SUPPORT

For maximum rigidity, rectangular tables, 60" or more wide, receive a hat-shaped, 1-7/16"H x 1-1/2"W, steel keel securely fastened to the underside of the center of the tabletop. Tables 48"D receive two steel keels. Tables 90" or wider also receive two extra legs located under the center of the table to provide added support. The additional legs are 2-1/4" square solid Maple with a 1/2" radius on vertical edges. Added legs are stained black.

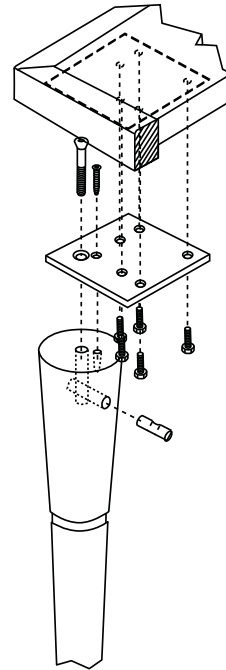

Matrix Series Wood Leg

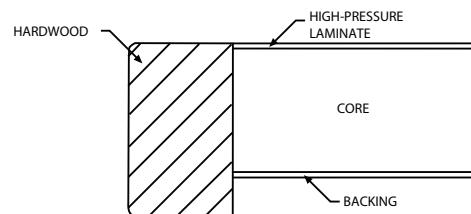

Matrix Series Drop Edge

Plywood Core Catalog No.	Particleboard Core Catalog No.	Description	H x W x D	Wt. (lbs.)	Plywood Core Price	Particleboard Core Price
Round Oak Table						
93-109-S00 OAK	93-109-S02 OAK	Adult Table	29"H x 36" Diameter	100	\$1,959	\$1,900
93-Y09-S00 OAK	93-Y09-S02 OAK	Youth Table	27-1/2"H x 36" Diameter	100	\$1,959	\$1,900
93-J09-S00 OAK	93-J09-S02 OAK	Juvenile Table	25"H x 36" Diameter	100	\$1,959	\$1,900
93-129-S00 OAK	93-129-S02 OAK	Adult Table	29"H x 42" Diameter	110	\$2,080	\$1,913
93-Y29-S00 OAK	93-Y29-S02 OAK	Youth Table	27-1/2"H x 42" Diameter	110	\$2,080	\$1,913
93-J29-S00 OAK	93-J29-S02 OAK	Juvenile Table	25"H x 42" Diameter	110	\$2,080	\$1,913
93-141-S00 OAK	93-141-S02 OAK	Adult Table	29"H x 48" Diameter	120	\$2,080	\$1,913
93-Y41-S00 OAK	93-Y41-S02 OAK	Youth Table	27-1/2"H x 48" Diameter	120	\$2,080	\$1,913
93-J41-S00 OAK	93-J41-S02 OAK	Juvenile Table	25"H x 48" Diameter	120	\$2,080	\$1,913
N/A	93-130-S02 OAK	Adult Table	29"H x 60" Diameter	140	N/A	\$2,698
N/A	93-Y30-S02 OAK	Youth Table	27-1/2"H x 60" Diameter	140	N/A	\$2,698
N/A	93-J30-S02 OAK	Juvenile Table	25"H x 60" Diameter	140	N/A	\$2,698

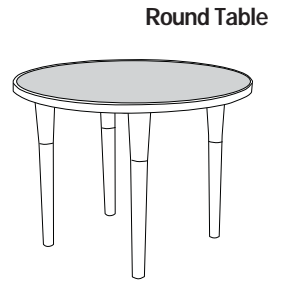

Round Maple Table						
93-109-S00 MAP	93-109-S02 MAP	Adult Table	29"H x 36" Diameter	100	\$2,136	\$2,071
93-Y09-S00 MAP	93-Y09-S02 MAP	Youth Table	27-1/2"H x 36" Diameter	100	\$2,136	\$2,071
93-J09-S00 MAP	93-J09-S02 MAP	Juvenile Table	25"H x 36" Diameter	100	\$2,136	\$2,071
93-129-S00 MAP	93-129-S02 MAP	Adult Table	29"H x 42" Diameter	110	\$2,268	\$2,085
93-Y29-S00 MAP	93-Y29-S02 MAP	Youth Table	27-1/2"H x 42" Diameter	110	\$2,268	\$2,085
93-J29-S00 MAP	93-J29-S02 MAP	Juvenile Table	25"H x 42" Diameter	110	\$2,268	\$2,085
93-141-S00 MAP	93-141-S02 MAP	Adult Table	29"H x 48" Diameter	120	\$2,268	\$2,085
93-Y41-S00 MAP	93-Y41-S02 MAP	Youth Table	27-1/2"H x 48" Diameter	120	\$2,268	\$2,085
93-J41-S00 MAP	93-J41-S02 MAP	Juvenile Table	25"H x 48" Diameter	120	\$2,268	\$2,085
N/A	93-130-S02 MAP	Adult Table	29"H x 60" Diameter	140	N/A	\$2,940
N/A	93-Y30-S02 MAP	Youth Table	27-1/2"H x 60" Diameter	140	N/A	\$2,940
N/A	93-J30-S02 MAP	Juvenile Table	25"H x 60" Diameter	140	N/A	\$2,940

Square Oak Table						
93-191-S00 OAK	93-191-S02 OAK	Adult Table	29" x 30" x 30"	110	\$1,717	\$1,605
93-Y91-S00 OAK	93-Y91-S02 OAK	Youth Table	27-1/2" x 30" x 30"	110	\$1,717	\$1,605
93-J91-S00 OAK	93-J91-S02 OAK	Juvenile Table	25" x 30" x 30"	110	\$1,717	\$1,605
93-137-S00 OAK	93-137-S02 OAK	Adult Table	29" x 42" x 42"	110	\$1,839	\$1,726
93-Y37-S00 OAK	93-Y37-S02 OAK	Youth Table	27-1/2" x 42" x 42"	110	\$1,839	\$1,726
93-J37-S00 OAK	93-J37-S02 OAK	Juvenile Table	25" x 42" x 42"	110	\$1,839	\$1,726
93-154-S00 OAK	93-154-S02 OAK	Adult Table	29" x 48" x 48"	110	\$1,973	\$1,859
93-Y54-S00 OAK	93-Y54-S02 OAK	Youth Table	27-1/2" x 48" x 48"	110	\$1,973	\$1,859
93-J54-S00 OAK	93-J54-S02 OAK	Juvenile Table	25" x 48" x 48"	110	\$1,973	\$1,859

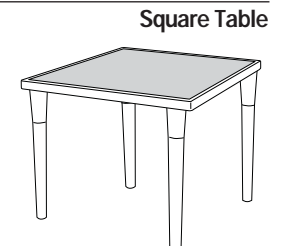

Square Maple Table						
93-191-S00 MAP	93-191-S02 MAP	Adult Table	29" x 30" x 30"	110	\$1,872	\$1,749
93-Y91-S00 MAP	93-Y91-S02 MAP	Youth Table	27-1/2" x 30" x 30"	110	\$1,872	\$1,749
93-J91-S00 MAP	93-J91-S02 MAP	Juvenile Table	25" x 30" x 30"	110	\$1,872	\$1,749
93-137-S00 MAP	93-137-S02 MAP	Adult Table	29" x 42" x 42"	110	\$2,004	\$1,881
93-Y37-S00 MAP	93-Y37-S02 MAP	Youth Table	27-1/2" x 42" x 42"	110	\$2,004	\$1,881
93-J37-S00 MAP	93-J37-S02 MAP	Juvenile Table	25" x 42" x 42"	110	\$2,004	\$1,881
93-154-S00 MAP	93-154-S02 MAP	Adult Table	29" x 48" x 48"	110	\$2,151	\$2,027
93-Y54-S00 MAP	93-Y54-S02 MAP	Youth Table	27-1/2" x 48" x 48"	110	\$2,151	\$2,027
93-J54-S00 MAP	93-J54-S02 MAP	Juvenile Table	25" x 48" x 48"	110	\$2,151	\$2,027

Please specify Wood Finish (Table 1) and High-Pressure Laminate (Table 2). Details can be found on page GEN 4.

Four-Reader Rectrangular Table

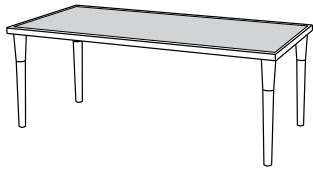

Plywood Core Catalog No.	Particleboard Core Catalog No.	Description	H x W x D	Wt. (lbs.)	Plywood Core Price	Particleboard Core Price
<u>Four-Reader Rectangular Oak Table</u>						
93-194-S00 OAK	93-194-S02 OAK	Adult Table	29" x 30" x 60"	120	\$1,872	\$1,695
93-Y94-S00 OAK	93-Y94-S02 OAK	Youth Table	27-1/2" x 30" x 60"	120	\$1,872	\$1,695
93-J94-S00 OAK	93-J94-S02 OAK	Juvenile Table	25" x 30" x 60"	120	\$1,872	\$1,695
93-195-S00 OAK	93-195-S02 OAK	Adult Table	29" x 30" x 72"	140	\$2,133	\$1,906
93-Y95-S00 OAK	93-Y95-S02 OAK	Youth Table	27-1/2" x 30" x 72"	140	\$2,133	\$1,906
93-J95-S00 OAK	93-J95-S02 OAK	Juvenile Table	25" x 30" x 72"	140	\$2,133	\$1,906
<u>Four-Reader Rectangular Maple Table</u>						
93-194-S00 MAP	93-194-S02 MAP	Adult Table	29" x 30" x 60"	120	\$2,041	\$1,848
93-Y94-S00 MAP	93-Y94-S02 MAP	Youth Table	27-1/2" x 30" x 60"	120	\$2,041	\$1,848
93-J94-S00 MAP	93-J94-S02 MAP	Juvenile Table	25" x 30" x 60"	120	\$2,041	\$1,848
93-195-S00 MAP	93-195-S02 MAP	Adult Table	29" x 30" x 72"	140	\$2,325	\$2,077
93-Y95-S00 MAP	93-Y95-S02 MAP	Youth Table	27-1/2" x 30" x 72"	140	\$2,325	\$2,077
93-J95-S00 MAP	93-J95-S02 MAP	Juvenile Table	25" x 30" x 72"	140	\$2,325	\$2,077

Six-Reader Rectrangular Table

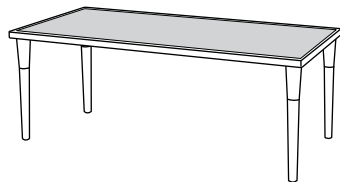

<u>Six-Reader Rectangular Oak Table</u>						
93-144-S00 OAK	93-144-S02 OAK	Adult Table	29" x 36" x 60"	120	\$1,953	\$1,776
93-Y44-S00 OAK	93-Y44-S02 OAK	Youth Table	27-1/2" x 36" x 60"	120	\$1,953	\$1,776
93-J44-S00 OAK	93-J44-S02 OAK	Juvenile Table	25" x 36" x 60"	120	\$1,953	\$1,776
93-138-S00 OAK	93-138-S02 OAK	Adult Table	29" x 36" x 72"	140	\$2,214	\$1,985
93-Y38-S00 OAK	93-Y38-S02 OAK	Youth Table	27-1/2" x 36" x 72"	140	\$2,214	\$1,985
93-J38-S00 OAK	93-J38-S02 OAK	Juvenile Table	25" x 36" x 72"	140	\$2,214	\$1,985
93-145-S00 OAK	93-145-S02 OAK	Adult Table	29" x 48" x 72"	170	\$2,348	\$2,161
93-Y45-S00 OAK	93-Y45-S02 OAK	Youth Table	27-1/2" x 48" x 72"	170	\$2,348	\$2,161
93-J45-S00 OAK	93-J45-S02 OAK	Juvenile Table	25" x 48" x 72"	170	\$2,348	\$2,161
<u>Six-Reader Rectangular Maple Table</u>						
93-144-S00 MAP	93-144-S02 MAP	Adult Table	29" x 36" x 60"	120	\$2,129	\$1,936
93-Y44-S00 MAP	93-Y44-S02 MAP	Youth Table	27-1/2" x 36" x 60"	120	\$2,129	\$1,936
93-J44-S00 MAP	93-J44-S02 MAP	Juvenile Table	25" x 36" x 60"	120	\$2,129	\$1,936
93-138-S00 MAP	93-138-S02 MAP	Adult Table	29" x 36" x 72"	140	\$2,413	\$2,165
93-Y38-S00 MAP	93-Y38-S02 MAP	Youth Table	27-1/2" x 36" x 72"	140	\$2,413	\$2,165
93-J38-S00 MAP	93-J38-S02 MAP	Juvenile Table	25" x 36" x 72"	140	\$2,413	\$2,165
93-145-S00 MAP	93-145-S02 MAP	Adult Table	29" x 48" x 72"	170	\$2,560	\$2,355
93-Y45-S00 MAP	93-Y45-S02 MAP	Youth Table	27-1/2" x 48" x 72"	170	\$2,560	\$2,355
93-J45-S00 MAP	93-J45-S02 MAP	Juvenile Table	25" x 48" x 72"	170	\$2,560	\$2,355

Please specify Wood Finish (Table 1) and High-Pressure Laminate (Table 2). Details can be found on page GEN 4.

Plywood Core Catalog No.	Particleboard Core Catalog No.	Description	H x W x D	Wt. (lbs.)	Plywood Core Price	Particleboard Core Price
<i>Rectangular Oak Table with Center Support Legs</i>						
93-198-S00 OAK	93-198-S02 OAK	Adult Table	29" x 30" x 90"	165	\$2,730	\$2,369
93-Y98-S00 OAK	93-Y98-S02 OAK	Youth Table	27-1/2" x 30" x 90"	165	\$2,730	\$2,369
93-J98-S00 OAK	93-J98-S02 OAK	Juvenile Table	25" x 30" x 90"	165	\$2,730	\$2,369
93-146-S00 OAK	93-146-S02 OAK	Adult Table	29" x 36" x 90"	165	\$2,811	\$2,449
93-Y46-S00 OAK	93-Y46-S02 OAK	Youth Table	27-1/2" x 36" x 90"	165	\$2,811	\$2,449
93-J46-S00 OAK	93-J46-S02 OAK	Juvenile Table	25" x 36" x 90"	165	\$2,811	\$2,449
93-134-S00 OAK	93-134-S02 OAK	Adult Table	29" x 48" x 90"	185	\$3,019	\$2,617
93-Y34-S00 OAK	93-Y34-S02 OAK	Youth Table	27-1/2" x 48" x 90"	185	\$3,019	\$2,617
93-J34-S00 OAK	93-J34-S02 OAK	Juvenile Table	25" x 48" x 90"	185	\$3,019	\$2,617
<i>Rectangular Maple Table with Center Support Legs</i>						
93-198-S00 MAP	93-198-S02 MAP	Adult Table	29" x 30" x 60"	165	\$2,976	\$2,582
93-Y98-S00 MAP	93-Y98-S02 MAP	Youth Table	27-1/2" x 30" x 60"	165	\$2,976	\$2,582
93-J98-S00 MAP	93-J98-S02 MAP	Juvenile Table	25" x 30" x 60"	165	\$2,976	\$2,582
93-146-S00 MAP	93-146-S02 MAP	Adult Table	29" x 36" x 90"	165	\$3,064	\$2,670
93-Y46-S00 MAP	93-Y46-S02 MAP	Youth Table	27-1/2" x 36" x 90"	165	\$3,064	\$2,670
93-J46-S00 MAP	93-J46-S02 MAP	Juvenile Table	25" x 36" x 90"	165	\$3,064	\$2,670
93-134-S00 MAP	93-134-S02 MAP	Adult Table	29" x 48" x 90"	185	\$3,291	\$2,853
93-Y34-S00 MAP	93-Y34-S02 MAP	Youth Table	27-1/2" x 48" x 90"	185	\$3,291	\$2,853
93-J34-S00 MAP	93-J34-S02 MAP	Juvenile Table	25" x 48" x 90"	185	\$3,291	\$2,853

Rectangular Table with Center Support Legs

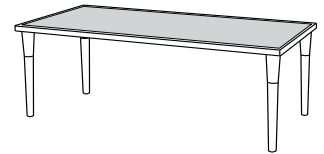

Please specify Wood Finish (Table 1) and High-Pressure Laminate (Table 2). Details can be found on page GEN 4.

General Specifications

TABLETOP

Standard tabletops are 1-3/16" thick, a plywood core or 3-ply particleboard core, as specified, including a top surface of .050" thick, high-pressure laminate, with a backing sheet not less than .020" thick for balanced construction, unless the top is over 72" long in which case it is .050" thick to prevent warping. High-pressure laminate has a lo-glare finish resistant to scratches, fading, and staining that meets or exceeds NEMA standards. Edges are white hardrock maple. This edge band is 5/8" thick x 1-5/8"W and is applied to the core after the top and bottom laminate sheets are applied making it an external edge. This wood edge band is rectangular in design with a 1/4" radius on the top and bottom front edges. The four tabletop corners are eased.

LEGS

Legs are 11-gauge steel angle measuring 4" x 4" at the top of the leg and 1-5/8" x 1-5/8" at the bottom of the leg. The leg has two compound tapers, one goes from the inside corners down 8" at a 12° angle. One goes from the outside corner down 8" at a 12° angle, the other one picks up there and continues down to the bottom of the leg at a 2° angle. The leg attaches to the underside of the tabletop using a 5" square x 5/16" thick steel plate. The plate is fillet welded to the inside top of the leg on two edges. The steel plate is attached to the underside of the tabletop with five 5/16"-18 x 1" long machine screws engaging internally and externally threaded metal bushings embedded into the underside of the tabletop. The leg plates are positioned behind, and hidden by, the extended table edge band. Each leg has an adjustable leveling floor glide. The metal legs are finished with an electrostatically applied epoxy-powder paint.

TABLETOP SUPPORT

For maximum rigidity, rectangular tables 60" or more long receive a 1-7/16"H x 1-1/2"W hat-shaped steel keel securely fastened to the underside of the center of the tabletop. Tables 48"D receive two steel keels. Tables 90" and longer also receive two extra legs located down the center of the table to provide added support. The additional legs are 2-1/4" square solid Maple with a 1/2" radius on vertical edges. Added legs are stained black.

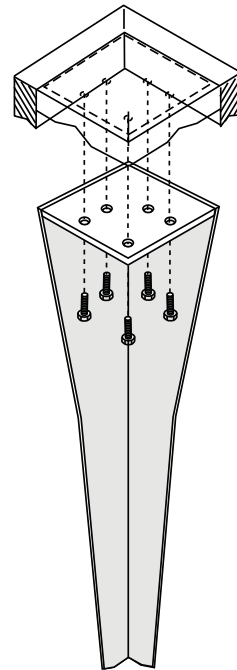

Matrix Series Metal Leg

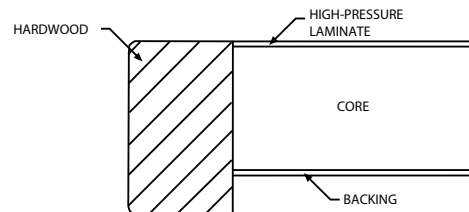

Matrix Series Drop Edge

Plywood Core Catalog No.	Particleboard Core Catalog No.	Description	H x W x D	Wt. (lbs.)	Plywood Core Price	Particleboard Core Price
Round Oak Table						
93M-109-S00 OAK	93M-109-S02 OAK	Adult Table	29"H x 36" Diameter	100	\$2,061	\$1,858
93M-Y09-S00 OAK	93M-Y09-S02 OAK	Youth Table	27-1/2"H x 36" Diameter	100	\$2,061	\$1,858
93M-J09-S00 OAK	93M-J09-S02 OAK	Juvenile Table	25"H x 36" Diameter	100	\$2,061	\$1,858
93M-129-S00 OAK	93M-129-S02 OAK	Adult Table	29"H x 42" Diameter	110	\$2,181	\$1,980
93M-Y29-S00 OAK	93M-Y29-S02 OAK	Youth Table	27-1/2"H x 42" Diameter	110	\$2,181	\$1,980
93M-J29-S00 OAK	93M-J29-S02 OAK	Juvenile Table	25"H x 42" Diameter	110	\$2,181	\$1,980
93M-141-S00 OAK	93M-141-S02 OAK	Adult Table	29"H x 48" Diameter	120	\$2,181	\$1,980
93M-Y41-S00 OAK	93M-Y41-S02 OAK	Youth Table	27-1/2"H x 48" Diameter	120	\$2,181	\$1,980
93M-J41-S00 OAK	93M-J41-S02 OAK	Juvenile Table	25"H x 48" Diameter	120	\$2,181	\$1,980
N/A	93M-130-S02 OAK	Adult Table	29"H x 60" Diameter	140	N/A	\$2,758
N/A	93M-Y30-S02 OAK	Youth Table	27-1/2"H x 60" Diameter	140	N/A	\$2,758
N/A	93M-J30-S02 OAK	Juvenile Table	25"H x 60" Diameter	140	N/A	\$2,758



Round Maple Table						
93M-109-S00 MAP	93M-109-S02 MAP	Adult Table	29"H x 36" Diameter	100	\$2,246	\$2,026
93M-Y09-S00 MAP	93M-Y09-S02 MAP	Youth Table	27-1/2"H x 36" Diameter	100	\$2,246	\$2,026
93M-J09-S00 MAP	93M-J09-S02 MAP	Juvenile Table	25"H x 36" Diameter	100	\$2,246	\$2,026
93M-129-S00 MAP	93M-129-S02 MAP	Adult Table	29"H x 42" Diameter	110	\$2,377	\$2,158
93M-Y29-S00 MAP	93M-Y29-S02 MAP	Youth Table	27-1/2"H x 42" Diameter	110	\$2,377	\$2,158
93M-J29-S00 MAP	93M-J29-S02 MAP	Juvenile Table	25"H x 42" Diameter	110	\$2,377	\$2,158
93M-141-S00 MAP	93M-141-S02 MAP	Adult Table	29"H x 48" Diameter	120	\$2,377	\$2,158
93M-Y41-S00 MAP	93M-Y41-S02 MAP	Youth Table	27-1/2"H x 48" Diameter	120	\$2,377	\$2,158
93M-J41-S00 MAP	93M-J41-S02 MAP	Juvenile Table	25"H x 48" Diameter	120	\$2,377	\$2,158
N/A	93M-130-S02 MAP	Adult Table	29"H x 60" Diameter	140	N/A	\$3,006
N/A	93M-Y30-S02 MAP	Youth Table	27-1/2"H x 60" Diameter	140	N/A	\$3,006
N/A	93M-J30-S02 MAP	Juvenile Table	25"H x 60" Diameter	140	N/A	\$3,006

Square Oak Table						
93M-191-S00 OAK	93M-191-S02 OAK	Adult Table	29" x 30" x 30"	110	\$1,789	\$1,657
93M-Y91-S00 OAK	93M-Y91-S02 OAK	Youth Table	27-1/2" x 30" x 30"	110	\$1,789	\$1,657
93M-J91-S00 OAK	93M-J91-S02 OAK	Juvenile Table	25" x 30" x 30"	110	\$1,789	\$1,657
93M-137-S00 OAK	93M-137-S02 OAK	Adult Table	29" x 42" x 42"	110	\$1,909	\$1,778
93M-Y37-S00 OAK	93M-Y37-S02 OAK	Youth Table	27-1/2" x 42" x 42"	110	\$1,909	\$1,778
93M-J37-S00 OAK	93M-J37-S02 OAK	Juvenile Table	25" x 42" x 42"	110	\$1,909	\$1,778
93M-154-S00 OAK	93M-154-S02 OAK	Adult Table	29" x 48" x 48"	110	\$2,044	\$1,913
93M-Y54-S00 OAK	93M-Y54-S02 OAK	Youth Table	27-1/2" x 48" x 48"	110	\$2,044	\$1,913
93M-J54-S00 OAK	93M-J54-S02 OAK	Juvenile Table	25" x 48" x 48"	110	\$2,044	\$1,913

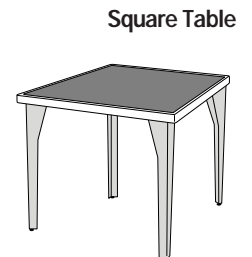

Square Maple Table						
93M-191-S00 MAP	93M-191-S02 MAP	Adult Table	29" x 30" x 30"	110	\$1,950	\$1,806
93M-Y91-S00 MAP	93M-Y91-S02 MAP	Youth Table	27-1/2" x 30" x 30"	110	\$1,950	\$1,806
93M-J91-S00 MAP	93M-J91-S02 MAP	Juvenile Table	25" x 30" x 30"	110	\$1,950	\$1,806
93M-137-S00 MAP	93M-137-S02 MAP	Adult Table	29" x 42" x 42"	110	\$2,081	\$1,938
93M-Y37-S00 MAP	93M-Y37-S02 MAP	Youth Table	27-1/2" x 42" x 42"	110	\$2,081	\$1,938
93M-J37-S00 MAP	93M-J37-S02 MAP	Juvenile Table	25" x 42" x 42"	110	\$2,081	\$1,938
93M-154-S00 MAP	93M-154-S02 MAP	Adult Table	29" x 48" x 48"	110	\$2,228	\$2,085
93M-Y54-S00 MAP	93M-Y54-S02 MAP	Youth Table	27-1/2" x 48" x 48"	110	\$2,228	\$2,085
93M-J54-S00 MAP	93M-J54-S02 MAP	Juvenile Table	25" x 48" x 48"	110	\$2,228	\$2,085

Please specify Wood Finish (Table 1), High-Pressure Laminate (Table 2) and Metal Color (Table 3). Details can be found on page GEN 4 and GEN 5.

Four-Reader Rectrangular Table

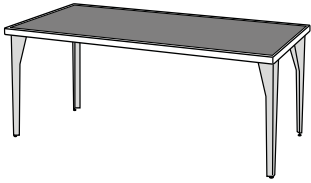

Plywood Core Catalog No.	Particleboard Core Catalog No.	Description	H x W x D	Wt. (lbs.)	Plywood Core Price	Particleboard Core Price
<u>Four-Reader Rectangular Oak Table</u>						
93M-194-S00 OAK	93M-194-S02 OAK	Adult Table	29" x 30" x 60"	120	\$1,920	\$1,754
93M-Y94-S00 OAK	93M-Y94-S02 OAK	Youth Table	27-1/2" x 30" x 60"	120	\$1,920	\$1,754
93M-J94-S00 OAK	93M-J94-S02 OAK	Juvenile Table	25" x 30" x 60"	120	\$1,920	\$1,754
93M-195-S00 OAK	93M-195-S02 OAK	Adult Table	29" x 30" x 72"	140	\$2,262	\$1,906
93M-Y95-S00 OAK	93M-Y95-S02 OAK	Youth Table	27-1/2" x 30" x 72"	140	\$2,262	\$1,906
93M-J95-S00 OAK	93M-J95-S02 OAK	Juvenile Table	25" x 30" x 72"	140	\$2,262	\$1,906
<u>Four-Reader Rectangular Maple Table</u>						
93M-194-S00 MAP	93M-194-S02 MAP	Adult Table	29" x 30" x 60"	120	\$2,092	\$1,911
93M-Y94-S00 MAP	93M-Y94-S02 MAP	Youth Table	27-1/2" x 30" x 60"	120	\$2,092	\$1,911
93M-J94-S00 MAP	93M-J94-S02 MAP	Juvenile Table	25" x 30" x 60"	120	\$2,092	\$1,911
93M-195-S00 MAP	93M-195-S02 MAP	Adult Table	29" x 30" x 72"	140	\$2,465	\$2,077
93M-Y95-S00 MAP	93M-Y95-S02 MAP	Youth Table	27-1/2" x 30" x 72"	140	\$2,465	\$2,077
93M-J95-S00 MAP	93M-J95-S02 MAP	Juvenile Table	25" x 30" x 72"	140	\$2,465	\$2,077

Six-Reader Rectrangular Table

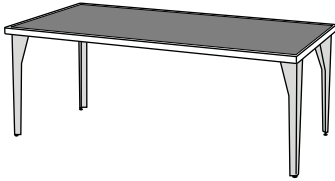

<u>Six-Reader Rectangular Oak Table</u>						
93M-144-S00 OAK	93M-144-S02 OAK	Adult Table	29" x 36" x 60"	120	\$1,999	\$1,834
93M-Y44-S00 OAK	93M-Y44-S02 OAK	Youth Table	27-1/2" x 36" x 60"	120	\$1,999	\$1,834
93M-J44-S00 OAK	93M-J44-S02 OAK	Juvenile Table	25" x 36" x 60"	120	\$1,999	\$1,834
93M-138-S00 OAK	93M-138-S02 OAK	Adult Table	29" x 36" x 72"	140	\$2,342	\$2,114
93M-Y38-S00 OAK	93M-Y38-S02 OAK	Youth Table	27-1/2" x 36" x 72"	140	\$2,342	\$2,114
93M-J38-S00 OAK	93M-J38-S02 OAK	Juvenile Table	25" x 36" x 72"	140	\$2,342	\$2,114
93M-145-S00 OAK	93M-145-S02 OAK	Adult Table	29" x 48" x 72"	170	\$2,629	\$2,274
93M-Y45-S00 OAK	93M-Y45-S02 OAK	Youth Table	27-1/2" x 48" x 72"	170	\$2,629	\$2,274
93M-J45-S00 OAK	93M-J45-S02 OAK	Juvenile Table	25" x 48" x 72"	170	\$2,629	\$2,274
<u>Six-Reader Rectangular Maple Table</u>						
93M-144-S00 MAP	93M-144-S02 MAP	Adult Table	29" x 36" x 60"	120	\$2,180	\$1,999
93M-Y44-S00 MAP	93M-Y44-S02 MAP	Youth Table	27-1/2" x 36" x 60"	120	\$2,180	\$1,999
93M-J44-S00 MAP	93M-J44-S02 MAP	Juvenile Table	25" x 36" x 60"	120	\$2,180	\$1,999
93M-138-S00 MAP	93M-138-S02 MAP	Adult Table	29" x 36" x 72"	140	\$2,552	\$2,303
93M-Y38-S00 MAP	93M-Y38-S02 MAP	Youth Table	27-1/2" x 36" x 72"	140	\$2,552	\$2,303
93M-J38-S00 MAP	93M-J38-S02 MAP	Juvenile Table	25" x 36" x 72"	140	\$2,552	\$2,303
93M-145-S00 MAP	93M-145-S02 MAP	Adult Table	29" x 48" x 72"	170	\$2,866	\$2,479
93M-Y45-S00 MAP	93M-Y45-S02 MAP	Youth Table	27-1/2" x 48" x 72"	170	\$2,866	\$2,479
93M-J45-S00 MAP	93M-J45-S02 MAP	Juvenile Table	25" x 48" x 72"	170	\$2,866	\$2,479

Please specify Wood Finish (Table 1), High-Pressure Laminate (Table 2) and Metal Color (Table 3). Details can be found on page GEN 4 and GEN 5.

Plywood Core Catalog No.	Particleboard Core Catalog No.	Description	H x W x D	Wt. (lbs.)	Plywood Core Price	Particleboard Core Price
<i>Rectangular Oak Table with Center Support Legs</i>						
93M-198-S00 OAK	93M-198-S02 OAK	Adult Table	29" x 30" x 90"	165	\$2,730	\$2,369
93M-Y98-S00 OAK	93M-Y98-S02 OAK	Youth Table	27-1/2" x 30" x 90"	165	\$2,730	\$2,369
93M-J98-S00 OAK	93M-J98-S02 OAK	Juvenile Table	25" x 30" x 90"	165	\$2,730	\$2,369
93M-146-S00 OAK	93M-146-S02 OAK	Adult Table	29" x 36" x 90"	165	\$2,885	\$2,583
93M-Y46-S00 OAK	93M-Y46-S02 OAK	Youth Table	27-1/2" x 36" x 90"	165	\$2,885	\$2,583
93M-J46-S00 OAK	93M-J46-S02 OAK	Juvenile Table	25" x 36" x 90"	165	\$2,885	\$2,583
93M-134-S00 OAK	93M-134-S02 OAK	Adult Table	29" x 48" x 90"	185	\$3,215	\$2,865
93M-Y34S00 OAK	93M-Y34-S02 OAK	Youth Table	27-1/2" x 48" x 90"	185	\$3,215	\$2,865
93M-J34-S00 OAK	93M-J34-S02 OAK	Juvenile Table	25" x 48" x 90"	185	\$3,215	\$2,865
<i>Rectangular Maple Table with Center Support Legs</i>						
93M-198-S00 MAP	93M-198-S02 MAP	Adult Table	29" x 30" x 60"	165	\$2,976	\$2,582
93M-Y98-S00 MAP	93M-Y98-S02 MAP	Youth Table	27-1/2" x 30" x 60"	165	\$2,976	\$2,582
93M-J98-S00 MAP	93M-J98-S02 MAP	Juvenile Table	25" x 30" x 60"	165	\$2,976	\$2,582
93M-146-S00 MAP	93M-146-S02 MAP	Adult Table	29" x 36" x 90"	165	\$3,145	\$2,816
93M-Y46-S00 MAP	93M-Y46-S02 MAP	Youth Table	27-1/2" x 36" x 90"	165	\$3,145	\$2,816
93M-J46-S00 MAP	93M-J46-S02 MAP	Juvenile Table	25" x 36" x 90"	165	\$3,145	\$2,816
93M-134-S00 MAP	93M-134-S02 MAP	Adult Table	29" x 48" x 90"	185	\$3,504	\$3,123
93M-Y34-S00 MAP	93M-Y34-S02 MAP	Youth Table	27-1/2" x 48" x 90"	185	\$3,504	\$3,123
93M-J34-S00 MAP	93M-J34-S02 MAP	Juvenile Table	25" x 48" x 90"	185	\$3,504	\$3,123

Rectangular Table with Center Support Legs

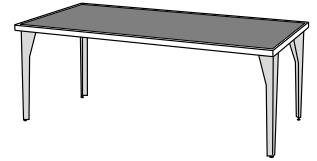

Please specify Wood Finish (Table 1), High-Pressure Laminate (Table 2) and Metal Color (Table 3). Details can be found on page GEN 4 and GEN 5.

General Specifications

TABLETOP

Standard tabletops are 1-3/16" thick, a plywood core or 3-ply particleboard core, as specified, including a top surface of .050" thick, high-pressure laminate, with a backing sheet not less than .020" thick for balanced construction, unless the top is over 72" long in which case it is .050" thick to prevent warping. High-pressure laminate has a lo-glare finish resistant to scratches, fading, and staining that meets or exceeds NEMA standards. Edges are white hardrock maple. This edge band is 5/8" thick x 1-5/8"W and is applied to the core after the top and bottom laminate sheets are applied making it an external edge. This wood edge band is rectangular in design with a 1/4" radius on the top and bottom front edges. The four tabletop corners are eased.

LEGS

Each leg is 2-1/2" diameter, 16-gauge steel tubing. Each leg has a 2-1/2" diameter x 1"H adjustable glide mounted into a recessed treaded insert. Legs attach to tabletops by means of a 5" square x 5/16" thick cold-rolled steel plate. The plate is fillet-welded to the leg. The steel plate is attached to the tabletop by five 5/16" x 1" machine bolts engaging internally and externally threaded bushings in the underside of the tabletop. Leg plates are positioned behind, and are hidden by, the extended table edge band.

TABLETOP SUPPORT

For maximum rigidity, rectangular tables, 60" or more wide, receive a V-shaped, 14-gauge steel keel securely fastened to the underside of the tabletop. Tables 48"D and more than 60"W, receive two steel keels parallel to the length of the table. Tables 90" or wider receive two extra matching legs located under the center of the table to provide added support.

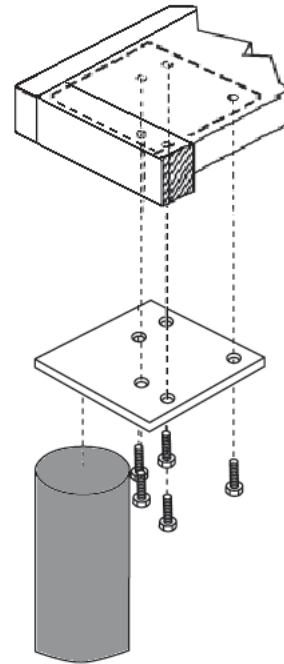

Matrix Series Round Metal Leg

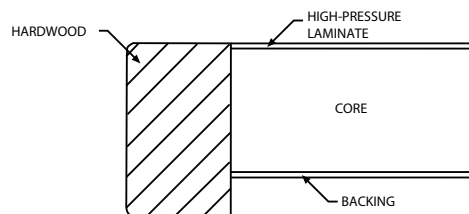

Matrix Series Drop Edge

Plywood Core Catalog No.	Particleboard Core Catalog No.	Description	H x W x D	Wt. (lbs.)	Plywood Core Price	Particleboard Core Price
Round Oak Table						
930-T-36RD-29B-RDM-S	930-T-36RD-29A-RDM-S	Adult Table	29"H x 36" Diameter	100	\$1,847	\$1,647
930-T-36RD-27B-RDM-S	930-T-36RD-27A-RDM-S	Youth Table	27-1/2"H x 36" Diameter	100	\$1,847	\$1,647
930-T-36RD-25B-RDM-S	930-T-36RD-25A-RDM-S	Juvenile Table	25"H x 36" Diameter	100	\$1,847	\$1,647
930-T-42RD-29B-RDM-S	930-T-42RD-29A-RDM-S	Adult Table	29"H x 42" Diameter	110	\$1,969	\$1,767
930-T-42RD-27B-RDM-S	930-T-42RD-27A-RDM-S	Youth Table	27-1/2"H x 42" Diameter	110	\$1,969	\$1,767
930-T-42RD-25B-RDM-S	930-T-42RD-25A-RDM-S	Juvenile Table	25"H x 42" Diameter	110	\$1,969	\$1,767
930-T-48RD-29B-RDM-S	930-T-48RD-29A-RDM-S	Adult Table	29"H x 48" Diameter	120	\$1,969	\$1,767
930-T-48RD-27B-RDM-S	930-T-48RD-27A-RDM-S	Youth Table	27-1/2"H x 48" Diameter	120	\$1,969	\$1,767
930-T-48RD-25B-RDM-S	930-T-48RD-25A-RDM-S	Juvenile Table	25"H x 48" Diameter	120	\$1,969	\$1,767
N/A	930-T-60RD-29A-RDM-S	Adult Table	29"H x 60" Diameter	140	N/A	\$2,546
N/A	930-T-60RD-27A-RDM-S	Youth Table	27-1/2"H x 60" Diameter	140	N/A	\$2,546
N/A	930-T-60RD-25A-RDM-S	Juvenile Table	25"H x 60" Diameter	140	N/A	\$2,546
Round Maple Table						
93M-T-36RD-29B-RDM-S	93M-T-36RD-29A-RDM-S	Adult Table	29"H x 36" Diameter	100	\$2,014	\$1,795
93M-T-36RD-27B-RDM-S	93M-T-36RD-27A-RDM-S	Youth Table	27-1/2"H x 36" Diameter	100	\$2,014	\$1,795
93M-T-36RD-25B-RDM-S	93M-T-36RD-25A-RDM-S	Juvenile Table	25"H x 36" Diameter	100	\$2,014	\$1,795
93M-T-42RD-29B-RDM-S	93M-T-42RD-29A-RDM-S	Adult Table	29"H x 42" Diameter	110	\$2,146	\$1,926
93M-T-42RD-27B-RDM-S	93M-T-42RD-27A-RDM-S	Youth Table	27-1/2"H x 42" Diameter	110	\$2,146	\$1,926
93M-T-42RD-25B-RDM-S	93M-T-42RD-25A-RDM-S	Juvenile Table	25"H x 42" Diameter	110	\$2,146	\$1,926
93M-T-48RD-29B-RDM-S	93M-T-48RD-29A-RDM-S	Adult Table	29"H x 48" Diameter	120	\$2,146	\$1,926
93M-T-48RD-27B-RDM-S	93M-T-48RD-27A-RDM-S	Youth Table	27-1/2"H x 48" Diameter	120	\$2,146	\$1,926
93M-T-48RD-25B-RDM-S	93M-T-48RD-25A-RDM-S	Juvenile Table	25"H x 48" Diameter	120	\$2,146	\$1,926
N/A	93M-T-60RD-29A-RDM-S	Adult Table	29"H x 60" Diameter	140	N/A	\$2,775
N/A	93M-T-60RD-27A-RDM-S	Youth Table	27-1/2"H x 60" Diameter	140	N/A	\$2,775
N/A	93M-T-60RD-25A-RDM-S	Juvenile Table	25"H x 60" Diameter	140	N/A	\$2,775
Square Oak Table						
930-T-3030-29B-RDM-S	930-T-3030-29A-RDM-S	Adult Table	29" x 30" x 30"	110	\$1,577	\$1,445
930-T-3030-27B-RDM-S	930-T-3030-27A-RDM-S	Youth Table	27-1/2" x 30" x 30"	110	\$1,577	\$1,445
930-T-3030-25B-RDM-S	930-T-3030-25A-RDM-S	Juvenile Table	25" x 30" x 30"	110	\$1,577	\$1,445
930-T-3636-29B-RDM-S	930-T-3636-29A-RDM-S	Adult Table	29" x 36" x 36"	110	\$1,640	\$1,504
930-T-3636-27B-RDM-S	930-T-3636-27A-RDM-S	Youth Table	27-1/2" x 36" x 36"	110	\$1,640	\$1,504
930-T-3636-25B-RDM-S	930-T-3636-25A-RDM-S	Juvenile Table	25" x 36" x 36"	110	\$1,640	\$1,504
930-T-4242-29B-RDM-S	930-T-4242-29A-RDM-S	Adult Table	29" x 42" x 42"	110	\$1,697	\$1,566
930-T-4242-27B-RDM-S	930-T-4242-27A-RDM-S	Youth Table	27-1/2" x 42" x 42"	110	\$1,697	\$1,566
930-T-4242-25B-RDM-S	930-T-4242-25A-RDM-S	Juvenile Table	25" x 42" x 42"	110	\$1,697	\$1,566
930-T-4848-29B-RDM-S	930-T-4848-29A-RDM-S	Adult Table	29" x 48" x 48"	110	\$1,832	\$1,701
930-T-4848-27B-RDM-S	930-T-4848-27A-RDM-S	Youth Table	27-1/2" x 48" x 48"	110	\$1,832	\$1,701
930-T-4848-25B-RDM-S	930-T-4848-25A-RDM-S	Juvenile Table	25" x 48" x 48"	110	\$1,832	\$1,701
Square Maple Table						
93M-T-3030-29B-RDM-S	93M-T-3030-29A-RDM-S	Adult Table	29" x 30" x 30"	110	\$1,719	\$1,575
93M-T-3030-27B-RDM-S	93M-T-3030-27A-RDM-S	Youth Table	27-1/2" x 30" x 30"	110	\$1,719	\$1,575
93M-T-3030-25B-RDM-S	93M-T-3030-25A-RDM-S	Juvenile Table	25" x 30" x 30"	110	\$1,719	\$1,575
93M-T-3636-29B-RDM-S	93M-T-3636-29A-RDM-S	Adult Table	29" x 36" x 36"	110	\$1,787	\$1,639
93M-T-3636-27B-RDM-S	93M-T-3636-27A-RDM-S	Youth Table	27-1/2" x 36" x 36"	110	\$1,787	\$1,639
93M-T-3636-25B-RDM-S	93M-T-3636-25A-RDM-S	Juvenile Table	25" x 36" x 36"	110	\$1,787	\$1,639
93M-T-4242-29B-RDM-S	93M-T-4242-29A-RDM-S	Adult Table	29" x 42" x 42"	110	\$1,850	\$1,707
93M-T-4242-27B-RDM-S	93M-T-4242-27A-RDM-S	Youth Table	27-1/2" x 42" x 42"	110	\$1,850	\$1,707
93M-T-4242-25B-RDM-S	93M-T-4242-25A-RDM-S	Juvenile Table	25" x 42" x 42"	110	\$1,850	\$1,707
93M-T-4848-29B-RDM-S	93M-T-4848-29A-RDM-S	Adult Table	29" x 48" x 48"	110	\$1,997	\$1,854
93M-T-4848-27B-RDM-S	93M-T-4848-27A-RDM-S	Youth Table	27-1/2" x 48" x 48"	110	\$1,997	\$1,854
93M-T-4848-25B-RDM-S	93M-T-4848-25A-RDM-S	Juvenile Table	25" x 48" x 48"	110	\$1,997	\$1,854

Round Table





Square Table



Please specify Wood Finish (Table 1), High-Pressure Laminate (Table 2) and Metal Color (Table 3). Details can be found on page GEN 4 and GEN 5.

The Matrix Collection

Tables with Round Metal Legs

	Plywood Core Catalog No.	Particleboard Core Catalog No.	Description	HxWxD	Wt. (lbs.)	Plywood Core Price	Particleboard Core Price
 <p>Four-Reader Rectrangular Table</p>	<i>Four-Reader Rectangular Oak Table</i>						
	930-T-3060-29B-RDM-S	930-T-3060-29A-RDM-S	Adult Table	29" x 30" x 60"	120	\$1,707	\$1,542
	930-T-3060-27B-RDM-S	930-T-3060-27A-RDM-S	Youth Table	27-1/2" x 30" x 60"	120	\$1,707	\$1,542
	930-T-3060-25B-RDM-S	930-T-3060-25A-RDM-S	Juvenile Table	25" x 30" x 60"	120	\$1,707	\$1,542
	930-T-3072-29B-RDM-S	930-T-3072-29A-RDM-S	Adult Table	29" x 30" x 72"	140	\$2,050	\$1,693
	930-T-3072-27B-RDM-S	930-T-3072-27A-RDM-S	Youth Table	27-1/2" x 30" x 72"	140	\$2,050	\$1,693
	930-T-3072-25B-RDM-S	930-T-3072-25A-RDM-S	Juvenile Table	25" x 30" x 72"	140	\$2,050	\$1,693
	<i>Four-Reader Rectangular Maple Table</i>						
	93M-T-3060-29B-RDM-S	93M-T-3060-29A-RDM-S	Adult Table	29" x 30" x 60"	120	\$1,860	\$1,680
	93M-T-3060-27B-RDM-S	93M-T-3060-27A-RDM-S	Youth Table	27-1/2" x 30" x 60"	120	\$1,860	\$1,680
	93M-T-3060-25B-RDM-S	93M-T-3060-25A-RDM-S	Juvenile Table	25" x 30" x 60"	120	\$1,860	\$1,680
	93M-T-3072-29B-RDM-S	93M-T-3072-29A-RDM-S	Adult Table	29" x 30" x 72"	140	\$2,235	\$1,846
93M-T-3072-27B-RDM-S	93M-T-3072-27A-RDM-S	Youth Table	27-1/2" x 30" x 72"	140	\$2,235	\$1,846	
93M-T-3072-25B-RDM-S	93M-T-3072-25A-RDM-S	Juvenile Table	25" x 30" x 72"	140	\$2,235	\$1,846	
 <p>Six-Reader Rectrangular Table</p>	<i>Six-Reader Rectangular Oak Table</i>						
	930-T-3660-29B-RDM-S	930-T-3660-29A-RDM-S	Adult Table	29" x 36" x 60"	120	\$1,788	\$1,622
	930-T-3660-27B-RDM-S	930-T-3660-27A-RDM-S	Youth Table	27-1/2" x 36" x 60"	120	\$1,788	\$1,622
	930-T-3660-25B-RDM-S	930-T-3660-25A-RDM-S	Juvenile Table	25" x 36" x 60"	120	\$1,788	\$1,622
	930-T-3672-29B-RDM-S	930-T-3672-29A-RDM-S	Adult Table	29" x 36" x 72"	140	\$2,129	\$1,901
	930-T-3672-27B-RDM-S	930-T-3672-27A-RDM-S	Youth Table	27-1/2" x 36" x 72"	140	\$2,129	\$1,901
	930-T-3672-25B-RDM-S	930-T-3672-25A-RDM-S	Juvenile Table	25" x 36" x 72"	140	\$2,129	\$1,901
	930-T-4872-29B-RDM-S	930-T-4872-29A-RDM-S	Adult Table	29" x 48" x 72"	170	\$2,417	\$2,062
	930-T-4872-27B-RDM-S	930-T-4872-27A-RDM-S	Youth Table	27-1/2" x 48" x 72"	170	\$2,417	\$2,062
	930-T-4872-25B-RDM-S	930-T-4872-25A-RDM-S	Juvenile Table	25" x 48" x 72"	170	\$2,417	\$2,062
	<i>Six-Reader Rectangular Maple Table</i>						
	93M-T-3660-29B-RDM-S	93M-T-3660-29A-RDM-S	Adult Table	29" x 36" x 60"	120	\$1,949	\$1,768
93M-T-3660-27B-RDM-S	93M-T-3660-27A-RDM-S	Youth Table	27-1/2" x 36" x 60"	120	\$1,949	\$1,768	
93M-T-3660-25B-RDM-S	93M-T-3660-25A-RDM-S	Juvenile Table	25" x 36" x 60"	120	\$1,949	\$1,768	
93M-T-3672-29B-RDM-S	93M-T-3672-29A-RDM-S	Adult Table	29" x 36" x 72"	140	\$2,321	\$2,072	
93M-T-3672-27B-RDM-S	93M-T-3672-27A-RDM-S	Youth Table	27-1/2" x 36" x 72"	140	\$2,321	\$2,072	
93M-T-3672-25B-RDM-S	93M-T-3672-25A-RDM-S	Juvenile Table	25" x 36" x 72"	140	\$2,321	\$2,072	
93M-T-4872-29B-RDM-S	93M-T-4872-29A-RDM-S	Adult Table	29" x 48" x 72"	170	\$2,635	\$2,248	
93M-T-4872-27B-RDM-S	93M-T-4872-27A-RDM-S	Youth Table	27-1/2" x 48" x 72"	170	\$2,635	\$2,248	
93M-T-4872-25B-RDM-S	93M-T-4872-25A-RDM-S	Juvenile Table	25" x 48" x 72"	170	\$2,635	\$2,248	

Please specify Wood Finish (Table 1), High-Pressure Laminate (Table 2) and Metal Color (Table 3). Details can be found on page GEN 4 and GEN 5.

Plywood Core Catalog No.	Particleboard Core Catalog No.	Description	HxWxD	Wt. (lbs.)	Plywood Core Price	Particleboard Core Price
<i>Rectangular Oak Table with Center Support Legs</i>						
930-T-3090-29B-RDM-S	930-T-3090-29A-RDM-S	Adult Table	29" x 30" x 90"	165	\$2,518	\$2,157
930-T-3090-27B-RDM-S	930-T-3090-27A-RDM-S	Youth Table	27-1/2" x 30" x 90"	165	\$2,518	\$2,157
930-T-3090-25B-RDM-S	930-T-3090-25A-RDM-S	Juvenile Table	25" x 30" x 90"	165	\$2,518	\$2,157
930-T-3690-29B-RDM-S	930-T-3690-29A-RDM-S	Adult Table	29" x 36" x 90"	165	\$2,674	\$2,371
930-T-3690-27B-RDM-S	930-T-3690-27A-RDM-S	Youth Table	27-1/2" x 36" x 90"	165	\$2,674	\$2,371
930-T-3690-25B-RDM-S	930-T-3690-25A-RDM-S	Juvenile Table	25" x 36" x 90"	165	\$2,674	\$2,371
930-T-4890-29B-RDM-S	930-T-4890-29A-RDM-S	Adult Table	29" x 48" x 90"	185	\$3,002	\$2,653
930-T-4890-27B-RDM-S	930-T-4890-27A-RDM-S	Youth Table	27-1/2" x 48" x 90"	185	\$3,002	\$2,653
930-T-4890-25B-RDM-S	930-T-4890-25A-RDM-S	Juvenile Table	25" x 48" x 90"	185	\$3,002	\$2,653
<i>Rectangular Maple Table with Center Support Legs</i>						
93M-T-3090-29B-RDM-S	93M-T-3090-29A-RDM-S	Adult Table	29" x 30" x 90"	165	\$2,745	\$2,351
93M-T-3090-27B-RDM-S	93M-T-3090-27A-RDM-S	Youth Table	27-1/2" x 30" x 90"	165	\$2,745	\$2,351
93M-T-3090-25B-RDM-S	93M-T-3090-25A-RDM-S	Juvenile Table	25" x 30" x 90"	165	\$2,745	\$2,351
93M-T-3690-29B-RDM-S	93M-T-3690-29A-RDM-S	Adult Table	29" x 36" x 90"	165	\$2,914	\$2,584
93M-T-3690-27B-RDM-S	93M-T-3690-27A-RDM-S	Youth Table	27-1/2" x 36" x 90"	165	\$2,914	\$2,584
93M-T-3690-25B-RDM-S	93M-T-3690-25A-RDM-S	Juvenile Table	25" x 36" x 90"	165	\$2,914	\$2,584
93M-T-4890-29B-RDM-S	93M-T-4890-29A-RDM-S	Adult Table	29" x 48" x 90"	185	\$2,272	\$2,892
93M-T-4890-27B-RDM-S	93M-T-4890-27A-RDM-S	Youth Table	27-1/2" x 48" x 90"	185	\$2,272	\$2,892
93M-T-4890-25B-RDM-S	93M-T-4890-25A-RDM-S	Juvenile Table	25" x 48" x 90"	185	\$2,272	\$2,892
<i>Trapezoid Oak Table</i>						
930-T-60TR-29B-RDM-S	930-T-60TR-29A-RDM-S	Adult Table	29" x 60" x 30"	120	\$1,969	\$1,778
930-T-60TR-27B-RDM-S	930-T-60TR-27A-RDM-S	Youth Table	27-1/2" x 60" x 30"	120	\$1,969	\$1,778
930-T-60TR-25B-RDM-S	930-T-60TR-25A-RDM-S	Juvenile Table	25" x 60" x 30"	120	\$1,969	\$1,778
<i>Trapezoid Maple Table</i>						
93M-T-60TR-29B-RDM-S	93M-T-60TR-29A-RDM-S	Adult Table	29" x 60" x 30"	120	\$2,146	\$1,938
93M-T-60TR-27B-RDM-S	93M-T-60TR-27A-RDM-S	Youth Table	27-1/2" x 60" x 30"	120	\$2,146	\$1,938
93M-T-60TR-25B-RDM-S	93M-T-60TR-25A-RDM-S	Juvenile Table	25" x 60" x 30"	120	\$2,146	\$1,938

Rectangular Table with Center Support Legs



Trapezoid Table



Please specify Wood Finish (Table 1), High-Pressure Laminate (Table 2) and Metal Color (Table 3). Details can be found on page GEN 4 and GEN 5.

General Specifications

TABLETOP

Standard tabletops are 1-3/16" thick 3-ply particleboard core, including a top surface of .050" thick, high-pressure laminate, with a backing sheet not less than .020" thick for balanced construction, unless the top is over 72" long in which case it is .050" thick to prevent warping. High-pressure laminate has a lo-glare finish resistant to scratches, fading, and staining that meets or exceeds NEMA standards. Edges are white hardrock maple. This edge band is 5/8" thick x 1-5/8"W and is applied to the core after the top and bottom laminate sheets are applied making it an external edge. This wood edge band is rectangular in design with a 1/4" radius on the top and bottom front edges. The four tabletop corners are eased.

Note: All standing height tables are apron leg type tables and all sitting height tables are apronless leg type tables.

LEGS (Wood without Apron)

Legs are round with compound tapers. The leg is 3-1/2" diameter at the top and 2-1/2" diameter 8" down from the top. At the bottom of the leg the diameter is 1-7/8". 8" down from the top of the leg is a vein-line 1/8"D x 1/8"W. The leg is one piece solid maple. The bottom of the leg has an 1/8" chamfer and an adjustable, leveling floor glide. The legs attach to the underside of the tabletop by means of a 5" square x 5/16" thick steel plate. The plate is attached to the leg by a 5/16" x 2-1/2" long machine bolt engaging a 5/8" diameter barrel nut inserted horizontally into the leg. The steel plate is attached to the underside of the tabletop by five 5/16"-18 x 1" long machine screws engaging internally and externally threaded metal bushings embedded into the underside of the tabletop. Leg plates are positioned behind, and hidden by, the extended table edge band. A 2-1/4" x 2-1/4" center leg, painted black, is used to help support the weight of computer equipment used on these types of tables.

LEGS (Wood with Apron on 39"H Tables)

Legs are round with compound tapers. The leg is 3-1/2" diameter at the top and 2-1/2" diameter 8" down from the top. At the bottom of the leg the diameter is 1-7/8". 8" down from the top of the leg is a vein-line 1/8" D x 1/8" W. The leg is one piece solid maple. The bottom of the leg has an 1/8" chamfer and an adjustable, leveling floor glide. The legs are secured by means of a 3-1/2"W x 1" thick apron that is secured to the tabletop by attaching hardwood cleats to the inside of the apron and screwing through the cleats into the underside of the top. The bottom front edge of the apron is radiused 1/4". The legs attach to the aprons by means of formed 14-gauge steel corner brackets. Each leg is bolted to the corner bracket with two 5/16"-18 hex head bolts that pass through the bracket and engage threaded metal bushings embedded into the leg.

LEGS (Metal)

Legs are 11-gauge steel angle measuring 4" x 4" at the top of the leg and 1-5/8" x 1-5/8" at the bottom of the leg. The leg has two compound tapers, one goes from the inside corners down 8" at a 12° angle. One goes from the outside corner down 8" at a 12° angle, the other one picks up there and continues down to the bottom of the leg at a 2° angle. The leg attaches to the underside of the tabletop using a 5" square x 5/16" thick steel plate. The plate is fillet welded to the inside

top of the leg on two edges. The steel plate is attached to the underside of the tabletop with five 5/16"-18 x 1" long machine screws engaging internally and externally threaded metal bushings embedded into the underside of the tabletop. The leg plates are positioned behind, and hidden by, the extended table edge band. Each leg has an adjustable leveling floor glide. The metal legs are finished with an electrostatically applied epoxy-powder paint.

LEGS (ROUND METAL)

Each leg is 2-1/2" diameter, 16-gauge steel tubing and has a 3-1/2" diameter x 2-5/8"H glued-up maple bun-foot as a design feature. Each bun-foot has a 2" diameter, adjustable glide mounted in a recessed tee-nut. The glide is further recessed into the bun-foot by means of a counter-sunk boring which accepts the upper two-thirds of the glide. Legs attach to tabletops by means of a 5" square x 5/16" thick cold-rolled steel plate. The plate is fillet-welded to the leg. The steel plate is attached to the tabletop by five 5/16" x 1" machine bolts engaging internally and externally threaded bushings in the underside of the tabletop. Leg plates are positioned behind, and be hidden by, the extended table edge band.

LEGS (Center)

Additional legs added to the center of the table for extra support are 2-1/4" square, solid maple with a 1/2" radius on vertical edges. Added legs are stained black.

PRIVACY PANEL

Privacy panels are 10"H x 10-3/8"D x 1" thick, these panels and the back panel are white maple plain-sliced, slip-matched tight side out A-A veneer plywood. Exposed edges are banded with 1.6mm matching maple wood. The privacy panel attaches securely to the tabletop by screws passing through the tabletop and into the bottom edges of the privacy panel. The privacy panel is assembled with metal keyways and shoulder screws. The end panels receive a series of black 1/2" design squares, two rows of four squares, and one row of three squares on the outside face. The squares are centered left to right and begin 1-1/2" down from the top edge of the panel.

ELECTRICAL WIRE MANAGEMENT

Each position receives a 3" diameter grommeted hole for power and data passage. J-channel wire managers are mounted under tabletop to hold these cords. The grommets are ABS black plastic and the J-channel is 18-gauge black powder-coated steel.

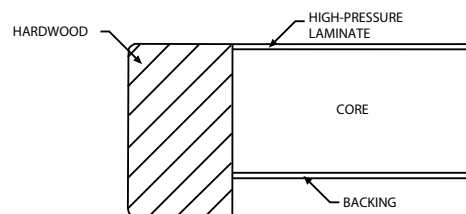

Matrix Series Drop Edge

Oak Catalog No.	Maple Catalog No.	Description	H x W x D	Wt. (lbs.)	Oak Price	Maple Price	Standing with Apron	Sitting without Apron
93-645-S00 OAK	93-645-S00 MAP	Sitting Height	27-1/2" x 30" x 24"	80	\$1,681	\$1,833	One Position Computer Tables	
93-665-S00 OAK	93-665-S00 MAP	Sitting Height	27-1/2" x 30" x 30"	80	\$1,762	\$1,921		

Note: Available in 27-1/2"H Sitting Height Only.



93-649-S00 OAK	93-649-S00 MAP	Sitting Height	27-1/2" x 60" x 24"	110	\$2,244	\$2,446	Two Position Computer Tables
93-669-S00 OAK	93-669-S00 MAP	Sitting Height	27-1/2" x 60" x 30"	110	\$2,379	\$2,593	

Note: Available in 27-1/2"H Sitting Height Only.

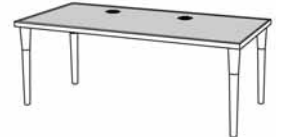

93-643-S00 OAK	93-643-S00 MAP	Sitting Height	27-1/2" x 36" x 24"	70	\$2,004	\$2,184	One Position Computer Table with 10"H Privacy Panel
93-663-S00 OAK	93-663-S00 MAP	Sitting Height	27-1/2" x 36" x 36"	80	\$2,137	\$2,329	
93-663-S05 OAK	93-663-S05 MAP	Standing Height	39" x 36" x 36"	85	\$2,194	\$2,392	

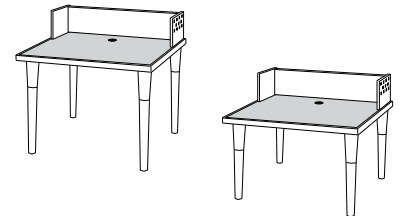

93-642-S00 OAK	93-642-S00 MAP	Sitting Height	27-1/2" x 72" x 24"	150	\$2,582	\$2,815	Two Position Computer Table with 10"H Privacy Panel
93-662-S00 OAK	93-662-S00 MAP	Sitting Height	27-1/2" x 72" x 36"	150	\$2,718	\$2,963	
93-662-S05 OAK	93-662-S05 MAP	Standing Height	39" x 72" x 36"	150	\$2,785	\$3,036	

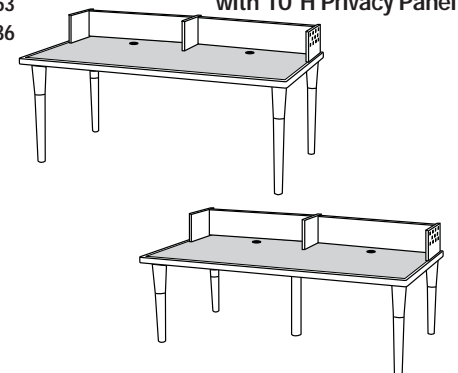

93-644-S00 OAK	93-644-S00 MAP	Sitting Height	27-1/2" x 90" x 24"	180	\$3,364	\$3,667	Three Position Computer Table with 10"H Privacy Panel
93-664-S00 OAK	93-664-S00 MAP	Sitting Height	27-1/2" x 90" x 36"	170	\$3,499	\$3,814	
93-664-S05 OAK	93-664-S05 MAP	Standing Height	39" x 90" x 36"	180	\$3,566	\$3,887	

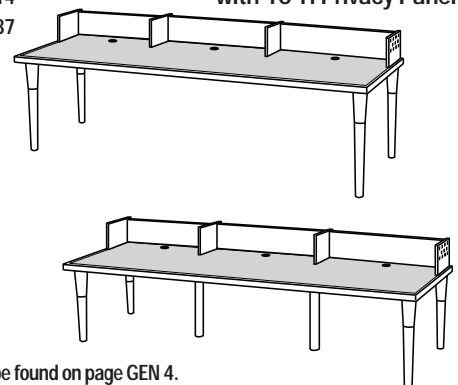

Please specify Wood Finish (Table 1) and High-Pressure Laminate (Table 2). Details can be found on page GEN 4.

The Matrix Collection

Computer Tables with Metal Legs

	Oak Catalog No.	Maple Catalog No.	Description	H x W x D	Wt. (lbs.)	Oak Price	Maple Price
One Position Computer Tables	93M-645-S00 OAK	93M-645-S00 MAP	Sitting Height	27-1/2" x 30" x 24"	80	\$1,745	\$1,902
	93M-665-S00 OAK	93M-665-S00 MAP	Sitting Height	27-1/2" x 30" x 30"	80	\$1,825	\$1,989



Two Position Computer Tables	93M-649-S00 OAK	93M-649-S00 MAP	Sitting Height	27-1/2" x 60" x 24"	110	\$2,308	\$2,515
	93M-669-S00 OAK	93M-669-S00 MAP	Sitting Height	27-1/2" x 60" x 30"	110	\$2,442	\$2,661

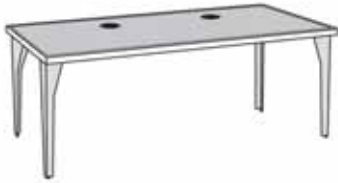

One Position Computer Table with 10"H Privacy Panel	93M-643-S00 OAK	93M-643-S00 MAP	Sitting Height	27-1/2" x 36" x 24"	70	\$2,066	\$2,252
	93M-663-S00 OAK	93M-663-S00 MAP	Sitting Height	27-1/2" x 36" x 36"	80	\$2,201	\$2,399



Two Position Computer Table with 10"H Privacy Panel	93M-642-S00 OAK	93M-642-S00 MAP	Sitting Height	27-1/2" x 72" x 24"	150	\$2,646	\$2,885
	93M-662-S00 OAK	93M-662-S00 MAP	Sitting Height	27-1/2" x 72" x 36"	150	\$2,780	\$3,031

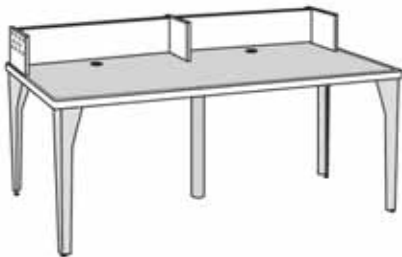

Three Position Computer Table with 10"H Privacy Panel	93M-644-S00 OAK	93M-644-S00 MAP	Sitting Height	27-1/2" x 90" x 24"	180	\$3,428	\$3,737
	93M-664-S00 OAK	93M-664-S00 MAP	Sitting Height	27-1/2" x 90" x 36"	170	\$3,562	\$3,883

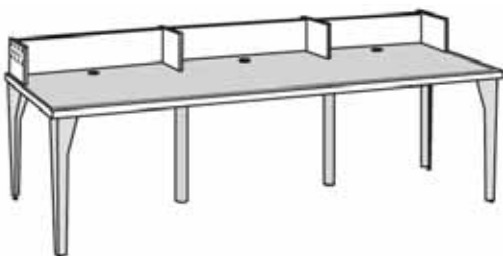

Note: Computer Tables with Metal Legs are available in 27-1/2"H Sitting Height Only.

Please specify Wood Finish (Table 1), High-Pressure Laminate (Table 2) and Metal Color (Table 3). Details can be found on page GEN 4 and GEN 5.

Oak Catalog No.	Maple Catalog No.	Description	H x W x D	Wt. (lbs.)	Oak Price	Maple Price	
930-ITGO-243027-RDM-S	93M-ITGO-243027-RDM-S	Sitting Height	27-1/2" x 30" x 24"	80	\$1,533	\$1,671	One Position Computer Tables
930-ITGO-303027-RDM-S	93M-ITGO-303027-RDM-S	Sitting Height	27-1/2" x 30" x 30"	80	\$1,613	\$1,758	



930-ITGO-246027-RDM-S	93M-ITGO-246027-RDM-S	Sitting Height	27-1/2" x 60" x 24"	110	\$2,096	\$2,285	Two Position Computer Tables
930-ITGO-306027-RDM-S	93M-ITGO-306027-RDM-S	Sitting Height	27-1/2" x 60" x 30"	110	\$2,230	\$2,431	



930-ITGS-243627-RDM-S	93M-ITGS-243627-RDM-S	Sitting Height	27-1/2" x 36" x 24"	70	\$1,854	\$2,021	One Position Computer Table with 10"H Privacy Panel
930-ITGS-363627-RDM-S	93M-ITGS-363627-RDM-S	Sitting Height	27-1/2" x 36" x 36"	80	\$1,989	\$2,168	



930-ITGS-247227-RDM-S	93M-ITGS-247227-RDM-S	Sitting Height	27-1/2" x 72" x 24"	150	\$2,435	\$2,654	Two Position Computer Table with 10"H Privacy Panel
930-ITGS-367227-RDM-S	93M-ITGS-367227-RDM-S	Sitting Height	27-1/2" x 72" x 36"	150	\$2,569	\$2,800	



930-ITGS-249027-RDM-S	93M-ITGS-249027-RDM-S	Sitting Height	27-1/2" x 90" x 24"	180	\$3,215	\$3,505	Three Position Computer Table with 10"H Privacy Panel
930-ITGS-369027-RDM-S	93M-ITGS-369027-RDM-S	Sitting Height	27-1/2" x 90" x 36"	170	\$3,350	\$3,652	

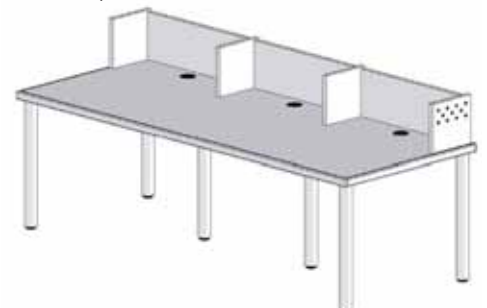

Note: Computer Tables with Metal Legs are available in 27-1/2"H Sitting Height Only.

Please specify Wood Finish (Table 1), High-Pressure Laminate (Table 2) and Metal Color (Table 3). Details can be found on page GEN 4 and GEN 5.

General Specifications

CARRELS AND ACCESS STATIONS

Carrels and access stations are of a modular starter and adder concept, an overall height of 48" and a work surface width of 36" for the carrel and 36" or 48" for the access station. The work surface depth is 27-1/2" with an additional 1-1/2"W space between the work surface and the back panel to allow passage of electrical and data cords. The work surface is attached to the end and intermediate panels by means of 22-1/2" long steel Z-brackets and 5/16"-18 hex head bolts. Intermediates and ends have 5/16"-18 internally and externally threaded bushings to accept the bolts.

WORK SURFACE

Standard work surfaces are 1-3/16" thick, 3-ply 45# density particleboard, including a top surface of .050" thick, high-pressure laminate, with a backing sheet no less than .020" thick for balanced construction. High-pressure laminate has a lo-glare finish resistant to scratches, fading, and staining that meets or exceeds NEMA standards. Front edge is white hardrock maple, this edge band is 5/8" thick x 1-5/8"W and is applied to the core after the top and bottom laminate sheets are applied making it an external edge. This wood edge band is rectangular in design with a 1/4" radius on the top and bottom front edges. The back edge of the work surface has a black plastic strip 1-1/2"W which projects above the work surface 1/4" to act as a paper and pencil retainer.

END AND INTERMEDIATE PANELS

Panels are 1-3/16" thick comprised of white northern grade A-A maple veneers, slip-matched tight side out over a particleboard core. The panels are externally banded on all four edges with 1.6mm matching wood. The bottom of each panel receives two flush mounted tee-nuts and two 2-5/16"L x 3/4"W x 1/8" T steel straps and two 1-1/4" diameter adjustable chrome floor glides. The end panels on starter units receive a series of black 1/2" design squares, two rows of 12 squares and one row of 11 squares, on the outside face. The squares are centered left to right and begin 3-3/4" down from the top edge of the panel.

BACK PANELS

Back panels are 3/4" thick comprised of white northern grade A-A maple veneers, slip-matched tight side out over a 45# density particleboard core. The panel is externally banded on the top and bottom with 1.6mm matching wood band.

SHELF

The shelf is 3/4" thick x 10"D white northern grade A-A maple veneers, slip-matched tight side out over a 45# density particleboard core. The front edge of the shelf has a 1-3/4"H x 5/8" thick solid white hardrock maple drop edge with a 1/4" radius on the top and bottom edges. The shelf attaches to the ends and intermediates by means of a pair of metal angle brackets. The back corners of the shelf on the access stations have a cutout in them to allow passage of power and data cords. The shelf is located above the work surface on carrels and below the work surface on access stations.

WORKING SPACE HEIGHTS

Working space height is adjustable. The carrel work surface may be set at 29"H or 32"H. The information access stations work surface may be set at 27"H, 32"H or 39"H.

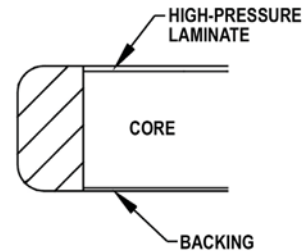

Matrix Series Flush Edge

Oak Catalog No.	Maple Catalog No.	Description	H x W x D	Wt. (lbs.)	Oak Price	Maple Price
-----------------	-------------------	-------------	-----------	------------	-----------	-------------

36" Wide Working Space

93-673-S00 OAK	93-673-S00 MAP	S/F Starter	48-1/4" x 38-3/8" x 30-11/16"	170	\$2,579	\$2,811
93-672-S00 OAK	93-672-S00 MAP	S/F Adder	48-1/4" x 37-3/16" x 30-11/16"	120	\$2,130	\$2,322

48" Wide Working Space

93-460-S00 OAK	93-460-S00 MAP	S/F Starter	48-1/4" x 50" x 30-11/16"	200	\$2,765	\$3,014
93-459-S00 OAK	93-459-S00 MAP	S/F Adder	48-1/4" x 48-13/16" x 30-11/16"	150	\$2,290	\$2,496

Single-Faced Information Access Workstations/Carrels

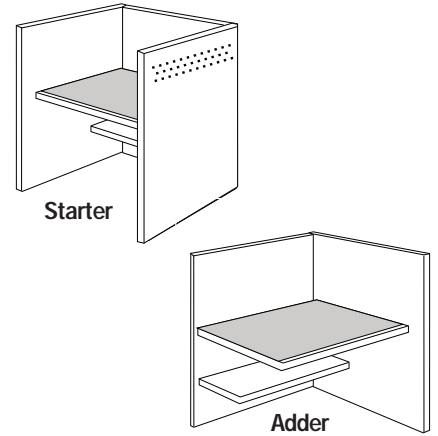

36" Wide Working Space

93-674-S00 OAK	93-674-S00 MAP	D/F Starter	48-1/4" x 38-3/8" x 59-5/8"	320	\$4,658	\$5,077
93-675-S00 OAK	93-675-S00 MAP	D/F Adder	48-1/4" x 37-3/16" x 59-5/8"	220	\$3,812	\$4,156

48" Wide Working Space

93-461-S00 OAK	93-461-S00 MAP	D/F Starter	48-1/4" x 50" x 59-5/8"	380	\$5,058	\$5,513
93-462-S00 OAK	93-462-S00 MAP	D/F Adder	48-1/4" x 48-13/16" x 59-5/8"	280	\$4,132	\$4,504

Double-Faced Information Access Workstations/Carrels

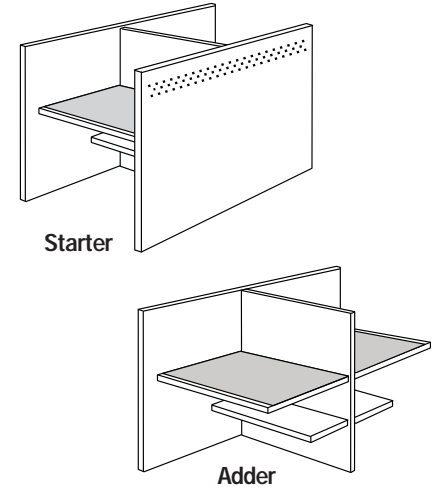

Please specify Wood Finish (Table 1) and High-Pressure Laminate (Table 2). Details can be found on page GEN 4.

General Specifications

WORKSTATIONS

Workstations are of modular starter and adder design, with an overall height of 34". Workstations are available in 36", 48", 72", 96", and 108" widths. A knee-space panel located below the work surface supports all work surfaces greater than 48"W. Work surface height is at 27-1/2". Work surface depth is 27-1/2" with an additional 1-1/2"W cord drop between the work surface and back panel to allow passage of electrical cords. Work surface is attached to end and intermediate panels by means of two metal 22-1/2" long "Z" brackets with 5/16"-18 hex-head bolts engaging internally and externally threaded bushings embedded into panels. The back panel is attached to end and intermediate panels using hidden metal keyways and shoulder screws. The shelf is attached to end and intermediate panels and back panels with 3/4" x 3/4" steel black painted angle brackets and black #8 screws.

WORK SURFACE

Standard work surface is 1-3/16" thick, 3-ply, 45# density particleboard, including a top surface of .050" thick, high-pressure laminate, with a backing sheet not less than .020" thick for balanced construction. High-pressure laminate has a lo-glare finish resistant to scratches, fading, and staining that meets or exceeds NEMA standards. Front edge is white hardrock maple. This edge band is 5/8" x 1-3/16"W and is applied to the core after the top and bottom laminate sheets are applied making it an external edge. This wood edge band is rectangular in design with a 1/4" radius on the top and bottom front edges. The back edge of the work surface has a black metal strip 1-1/2"W which projects above the work surface a 1/4" to act as a paper and pencil retainer.

END AND INTERMEDIATE PANELS

End and intermediate panels are 1-3/16" thick comprised of white northern-grown grade A-A plain-sliced maple veneers, slip-matched on both faces. The four edges are banded with matching maple wood banding. The core is 45# density particleboard. Each panel has two adjustable leveling floor glides. Intermediate panels have a 3" diameter grommet below the work surface to allow passage of power and data cords. The outside faces of the end panels receive a series of black 1/2" design squares, two rows of 12 squares and one row of 11 squares. The squares are centered left and right and begin 3-3/4" down from the top edge.

BACK PANEL

Back panel is 3/4" thick with the same veneer spec as the end panels. Back panels on double-faced units have a 3" diameter grommet below the work surface.

SHELF/WIRE MANAGEMENT COMPARTMENT

Shelf is maple, 3/4" thick and attaches to the uprights by means of a pair of metal angle brackets. The shelf is positioned 10" below the bottom of the work surface. The compartment has sliding front doors to access the electrical items behind the doors. The doors slide in aluminum tracks at the top and bottom of the doors.

WORKING SPACE HEIGHT

The working space is fixed at 27"H.

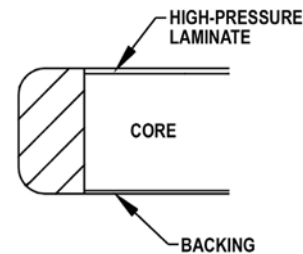

Matrix Series Flush Edge

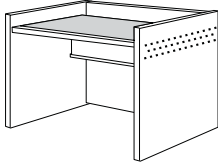
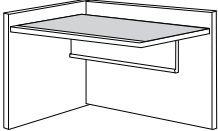
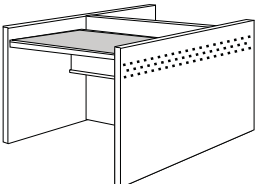
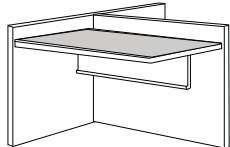
Oak Catalog No.	Maple Catalog No.	Description	H x W x D	Wt. (lbs.)	Oak Price	Maple Price	
<u>36" Wide Working Space</u>							Single-Faced One-Position Starter 
93-S31-SS0 OAK	93-S31-SS0 MAP	One-Position S/F Starter	33-1/2" x 37-1/2" x 31"	130	\$2,151	\$2,345	
93-S41-SS0 OAK	93-S41-SS0 MAP	One-Position S/F Starter	33-1/2" x 49-1/4" x 31"	155	\$2,296	\$2,503	
<u>48" Wide Working Space</u>							Adder 
93-S31-SAO OAK	93-S31-SAO MAP	One-Position S/F Adder	33-1/2" x 36-1/2" x 31"	100	\$1,752	\$1,910	
93-S41-SAO OAK	93-S41-SAO MAP	One-Position S/F Adder	33-1/2" x 48" x 31"	125	\$1,862	\$2,030	
<u>36" Wide Working Space</u>							Double-Faced One-Position Starter 
93-D31-SS0 OAK	93-D31-SS0 MAP	One-Position D/F Starter	33-1/2" x 37-1/2" x 59-1/2"	215	\$3,884	\$4,234	
93-D41-SS0 OAK	93-D41-SS0 MAP	One-Position D/F Starter	33-1/2" x 49-1/4" x 59-1/2"	255	\$4,141	\$4,513	
<u>48" Wide Working Space</u>							Adder 
93-D31-SAO OAK	93-D31-SAO MAP	One-Position D/F Adder	33-1/2" x 36-1/2" x 59-1/2"	155	\$3,123	\$3,404	
93-D41-SAO OAK	93-D41-SAO MAP	One-Position D/F Adder	33-1/2" x 48" x 59-1/2"	195	\$3,358	\$3,660	

Please specify Wood Finish (Table 1) and High-Pressure Laminate (Table 2). Details can be found on page GEN 4.

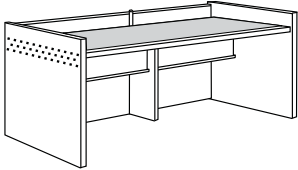
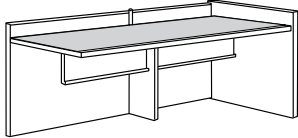
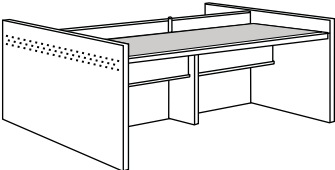
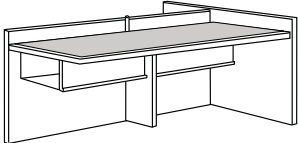
	Oak Catalog No.	Maple Catalog No.	Description	H x W x D	Wt. (lbs.)	Oak Price	Maple Price
Single-Faced Two-Position							
<i>36" Wide Working Space</i>							
Starter 	93-S32-SS0 OAK	93-S32-SS0 MAP	Two-Position S/F Starter	33-1/2" x 74" x 31"	195	\$2,962	\$3,229
	93-S42-SS0 OAK	93-S42-SS0 MAP	Two-Position S/F Starter	33-1/2" x 97-1/4" x 31"	235	\$3,202	\$3,490
<i>48" Wide Working Space</i>							
Adder 	93-S32-SAO OAK	93-S32-SAO MAP	Two-Position S/F Adder	33-1/2" x 73" x 31"	165	\$2,527	\$2,755
	93-S42-SAO OAK	93-S42-SAO MAP	Two-Position S/F Adder	33-1/2" x 96" x 31"	205	\$2,754	\$3,002
Double-Faced Two-Position							
<i>36" Wide Working Space</i>							
Starter 	93-D32-SS0 OAK	93-D32-SS0 MAP	Two-Position D/F Starter	33-1/2" x 74" x 59-1/2"	330	\$5,303	\$5,780
	93-D42-SS0 OAK	93-D42-SS0 MAP	Two-Position D/F Starter	33-1/2" x 97-1/4" x 59-1/2"	410	\$5,720	\$6,235
<i>48" Wide Working Space</i>							
Adder 	93-D32-SAO OAK	93-D32-SAO MAP	Two-Position D/F Adder	33-1/2" x 73" x 59-1/2"	270	\$4,571	\$4,982
	93-D42-SAO OAK	93-D42-SAO MAP	Two-Position D/F Adder	33-1/2" x 96" x 59-1/2"	155	\$4,981	\$5,430

Please specify Wood Finish (Table 1) and High-Pressure Laminate (Table 2). Details can be found on page GEN 4.

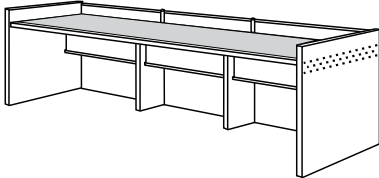
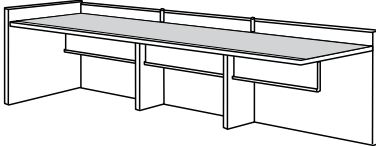
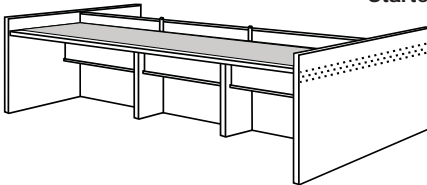
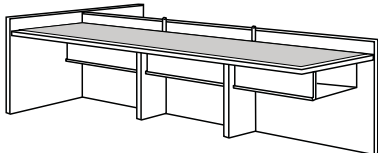
Oak Catalog No.	Maple Catalog No.	Description	H x W x D	Wt. (lbs.)	Oak Price	Maple Price	
<i>36" Wide Working Space</i>							Single-Faced Three-Position Starter
93-S33-SS0 OAK	93-S33-SS0 MAP	Three-Position S/F Starter	33-1/2" x 110-1/2" x 31"	260	\$3,926	\$4,279	
							Adder
93-S33-SA0 OAK	93-S33-SA0 MAP	Three-Position S/F Adder	33-1/2" x 109-1/4" x 31"	230	\$3,324	\$3,623	
<i>36" Wide Working Space</i>							Double-Faced Three-Position Starter
93-D33-SS0 OAK	93-D33-SS0 MAP	Three-Position D/F Starter	33-1/2" x 110-1/2" x 59-1/2"	445	\$7,060	\$7,695	
							Adder
93-D33-SA0 OAK	93-D33-SA0 MAP	Three Position D/F Adder	33-1/2" x 109-1/4" x 59-1/2"	385	\$6,269	\$6,833	

Please specify Wood Finish (Table 1) and High-Pressure Laminate (Table 2). Details can be found on page GEN 4.

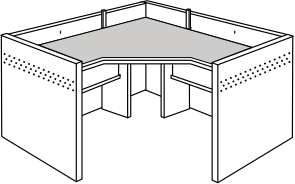
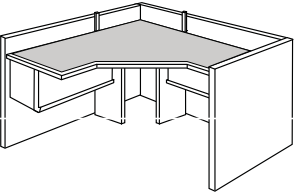
	Oak Catalog No.	Maple Catalog No.	Description	H x W x D	Wt. (lbs.)	Oak Price	Maple Price
90° Functional Corner Unit Starter 	93-SCR-SS0 OAK	93-SCR-SS0 MAP	90-Degree Functional Corner Starter	33-1/2" x 62" x 31"	225	\$4,739	\$5,165
Adder 	93-SCR-SA0 OAK	93-SCR-SA0 MAP	90-Degree Functional Corner Adder	33-1/2" x 62" x 31"	195	\$4,435	\$4,834

Please specify Wood Finish (Table 1) and High-Pressure Laminate (Table 2). Details can be found on page GEN 4.

General Specifications

WORK SURFACE

Work surface is 1-3/16" thick, 3-ply 45# density particleboard, including a top surface of .050" thick, high-pressure laminate, with a backing sheet not less than .020" thick for balanced construction. High-pressure laminate has a lo-glare finish resistant to scratches, fading, and staining that meets or exceeds NEMA standards. The front edges are white hardrock maple. This edge band is 5/8" thick x 1-5/8"W and is applied to the core after the top and bottom laminate sheets are applied making it an external edge. This wood edge band is rectangular in design with a 1/4" radius on the top and bottom front edges. There is a 1-1/2" space between the back of the work surface and the back panel to allow passage of power and data cords. The back edge of the work surface has a black plastic strip 1-1/2"W which projects above the work surface 1/4" to act as a paper and pencil retainer. The work surface is attached to the end and intermediate panels by means of 22-1/2" long steel "Z"-brackets and 5/16"-18 hex head bolts. Intermediates and ends have 5/16"-18 internally and externally threaded bushings embedded in them to accept the bolts.

END AND INTERMEDIATE PANELS

Panels are 1-3/16" thick comprised of white northern grade A-A maple veneers, slip-matched tight side out over a particleboard core. The panels are externally banded on all four edges with 1.6mm matching wood. The bottom of each panel receive two flush mounted tee-nuts and two 2-5/16"L x 3/4"W x 1/8" T steel straps and two 1-1/4" diameter adjustable chrome floor glides. The end and intermediate panels receive a series of 1/2" design squares, two rows of two squares and one row of one square, on each face. The squares begin 1-1/2" down from the top edge of each panel and 1-1/2" in from the front edge of each panel.

BACK PANELS

Back panels are 3/4" thick, comprised of white northern grade A-A maple veneers, slip-matched tight side out over a 45# density particleboard core. The panel is externally banded on the top and bottom with 1.6mm matching wood band. The back panels attach to the ends and/or intermediates by means of triangular maple wood posts and hidden keyways and shoulder screws. One of the back panels have an electrical access door, all of the back panels have a 3" diameter grommet hole for power and data cord passage.

SHELF

The shelf is 3/4" thick x 10"D, with matching maple veneers over a 45# density particleboard core. The front edge of the shelf has matching wood edge. The shelf attaches to the ends and intermediates by means of a pair of metal angle brackets.

WORKING SPACE HEIGHTS

Working space is adjustable to:

Standing Height: 39"

ADA Height: 32"

Sitting Height: 27"

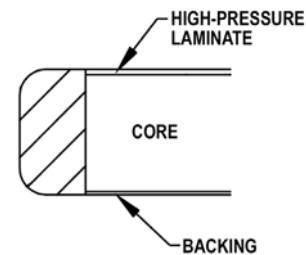

Matrix Series Flush Edge

Oak Catalog No.	Maple Catalog No.	Description	H x W x D	Wt. (lbs.)	Oak Price	Maple Price	
93-682-S00 OAK	93-682-S00 MAP	Six position with angular tops.	42-1/4" x 99-1/4" x 99-1/4"	629	\$13,910	\$15,162	<p>Six Position PAC Station</p>
93-685-S00 OAK	93-685-S00 MAP	Three position with angular tops. Composed of one starter unit and two adder units.	42-1/4" x 99-1/2" x 47-1/2"	401	\$7,319	\$7,978	<p>Three Position PAC Station</p>

Please specify Wood Finish (Table 1) and High-Pressure Laminate (Table 2). Details can be found on page GEN 4.

	Oak Catalog No.	Maple Catalog No.	Description	H x W x D	Wt. (lbs.)	Oak Price	Maple Price
Dictionary Stand	93-869-S00 OAK	93-869-S00 MAP	Adult Height	45" x 25-7/8" x 15-3/4"	80	\$2,234	\$2,435
	93-469-S00 OAK	93-469-S00 MAP	Children's Height	38" x 26-3/8" x 15-3/4"	67	\$2,234	\$2,435

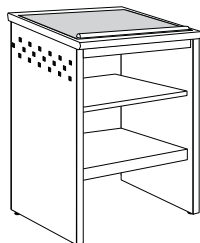

The top of the dictionary stand slopes down toward the front of the unit at a 10° angle. The top is 1-3/16" thick, consisting of a 45# density particleboard core, a top surface of .050" thick high-pressure laminate, with a backing sheet not less than .020" thick. A 5/8" x 5/8" book retainer at the front of the top keeps books from sliding off. The top edges receive maple bands. The unit has a full back panel which matches the end panels. The end panels are 1-3/16" thick with A-A plain-sliced white maple veneer, slip-matched, edges receive matching wood edge bands. The bottom edge of each end receives two adjustable floor glides. There is one adjustable shelf and one bottom fixed maple shelf. The end panels receive a series of black 1/2" design squares, two rows of six squares and one row of five squares, on the outside face. The squares are centered left to right and begin 1-1/2" down from the top front edge of the panel.

Atlas Stand	93-871-S00 OAK	93-871-S00 MAP	Adult Height	45" x 30" x 28-1/4"	200	\$4,019	\$4,381
	93-471-S00 OAK	93-471-S00 MAP	Children's Height	38" x 30" x 28-1/4"	180	\$4,019	\$4,381

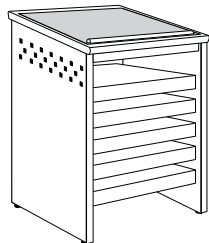

The top of the atlas stand slopes down toward the front of the unit at a 10° angle. The top is 1-3/16" thick, consisting of a 45# density particleboard core, a top surface of .050" thick high-pressure laminate, with a backing sheet not less than .020" thick. A 5/8" x 5/8" book retainer at the front of the top keeps books from sliding off. The top edges receive maple bands. The unit has a full back panel which matches the end panels. The end panels are 1-3/16" thick with A-A plain-sliced white maple veneer, slip-matched edges receive matching wood edge bands. The bottom edge of each end receives two adjustable floor glides. There are five pull-out maple shelves on metal slides with a positive stop to prevent accidental removal. The shelves are 25-7/8"W x 23-7/8"D, with 3-1/2" space between them. The children's height atlas stand has four pull-out shelves, with 3-1/2" usable space between the shelves. The end panels receive a series of black 1/2" design squares, two rows of ten squares and one row of nine squares, on the outside face. The squares are centered left to right and begin 1-1/2" down from the top front edge of the panel.

OPAC Station	93-039-S00 OAK	93-039-S00 MAP	End-of-Range Computer Station	38-3/16" x 24-1/8" x 20"	110	\$1,889	\$2,059
---------------------	----------------	----------------	-------------------------------	--------------------------	-----	---------	---------

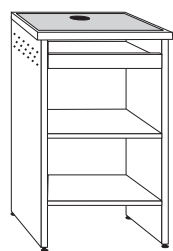

Designed to fit at end of doublefaced shelving range. Standard tabletop is 1-3/16" thick with high-pressure laminate on the top surface, with one 3" diameter grommet, and with 5/8" thick external solid wood edge bands. End panels are 1-3/16" thick wood veneered and edge banded. Unit has two full-depth fixed shelves with 3" diameter grommets and one pullout shelf for the keyboard. Space above the fixed shelves is 11". Adjustable glides are provided for leveling the unit.

Please specify Wood Finish (Table 1) and High-Pressure Laminate (Table 2). Details can be found on page GEN 4.

Oak Catalog No.	Maple Catalog No.	Description	Wt. (lbs.)	Oak Price	Maple Price
<i>To Cover ONE UNIT</i>					
93-W10-S01 OAK	93-W10-S01 MAP	10"D, Single-Faced	11	\$287	\$301
93-W12-S01 OAK	93-W12-S01 MAP	12"D, Single-Faced	14	\$289	\$303
93-W20-S01 OAK	93-W20-S01 MAP	20"D, Double-Faced	23	\$406	\$426
93-W24-S01 OAK	93-W24-S01 MAP	24"D, Double-Faced	27	\$452	\$475
<i>To Cover TWO UNITS</i>					
93-W10-S02 OAK	93-W10-S02 MAP	10"D, Single-Faced	22	\$379	\$398
93-W12-S02 OAK	93-W12-S02 MAP	12"D, Single-Faced	28	\$402	\$422
93-W20-S02 OAK	93-W20-S02 MAP	20"D, Double-Faced	46	\$569	\$598
93-W24-S02 OAK	93-W24-S02 MAP	24"D, Double-Faced	54	\$714	\$750
<i>To Cover THREE UNITS</i>					
93-W10-S03 OAK	93-W10-S03 MAP	10"D, Single-Faced	33	\$495	\$520
93-W12-S03 OAK	93-W12-S03 MAP	12"D, Single-Faced	42	\$525	\$551
93-W20-S03 OAK	93-W20-S03 MAP	20"D, Double-Faced	69	\$718	\$754
93-W24-S03 OAK	93-W24-S03 MAP	24"D, Double-Faced	81	\$757	\$795
<i>To Cover FOUR UNITS</i>					
93-W10-S04 OAK	93-W10-S04 MAP	10"D, Single-Faced	44	\$755	\$793
93-W12-S04 OAK	93-W12-S04 MAP	12"D, Single-Faced	56	\$801	\$840
93-W20-S04 OAK	93-W20-S04 MAP	20"D, Double-Faced	92	\$1,124	\$1,180
93-W24-S04 OAK	93-W24-S04 MAP	24"D, Double-Faced	108	\$1,211	\$1,272
<i>To Cover FIVE UNITS</i>					
93-W10-S05 OAK	93-W10-S05 MAP	10"D, Single-Faced	55	\$872	\$916
93-W12-S05 OAK	93-W12-S05 MAP	12"D, Single-Faced	70	\$928	\$974
93-W20-S05 OAK	93-W20-S05 MAP	20"D, Double-Faced	115	\$1,289	\$1,353
93-W24-S05 OAK	93-W24-S05 MAP	24"D, Double-Faced	135	\$1,473	\$1,547
<i>To Cover SIX UNITS</i>					
93-W10-S06 OAK	93-W10-S06 MAP	10"D, Single-Faced	66	\$986	\$1,035
93-W12-S06 OAK	93-W12-S06 MAP	12"D, Single-Faced	84	\$1,056	\$1,108
93-W20-S06 OAK	93-W20-S06 MAP	20"D, Double-Faced	138	\$1,435	\$1,506
93-W24-S06 OAK	93-W24-S06 MAP	24"D, Double-Faced	162	\$1,513	\$1,589
<i>To Cover SEVEN UNITS</i>					
93-W10-S07 OAK	93-W10-S07 MAP	10"D, Single-Faced	77	\$1,271	\$1,334
93-W12-S07 OAK	93-W12-S07 MAP	12"D, Single-Faced	98	\$1,347	\$1,415
93-W20-S07 OAK	93-W20-S07 MAP	20"D, Double-Faced	161	\$1,838	\$1,930
93-W24-S07 OAK	93-W24-S07 MAP	24"D, Double-Faced	189	\$1,965	\$2,064
<i>To Cover EIGHT UNITS</i>					
93-W10-S08 OAK	93-W10-S08 MAP	10"D, Single-Faced	88	\$1,363	\$1,431
93-W12-S08 OAK	93-W12-S08 MAP	12"D, Single-Faced	112	\$1,454	\$1,527
93-W20-S08 OAK	93-W20-S08 MAP	20"D, Double-Faced	184	\$2,005	\$2,105
93-W24-S08 OAK	93-W24-S08 MAP	24"D, Double-Faced	216	\$2,228	\$2,340
<i>To Cover NINE UNITS</i>					
93-W10-S09 OAK	93-W10-S09 MAP	10"D, Single-Faced	99	\$1,479	\$1,553
93-W12-S09 OAK	93-W12-S09 MAP	12"D, Single-Faced	126	\$1,580	\$1,659
93-W20-S09 OAK	93-W20-S09 MAP	20"D, Double-Faced	207	\$2,155	\$2,263
93-W24-S09 OAK	93-W24-S09 MAP	24"D, Double-Faced	243	\$2,268	\$2,381

Note: Single-Faced Tops are banded on both ends and on the front edge only. Back edge is not banded.
Double-Faced Tops are banded on both ends and on the front and back edges.

Please specify Wood Finish (Table 1) and High-Pressure Laminate (Table 2). Details can be found on page GEN 4.

Oak Catalog No.	Maple Catalog No.	Description	Wt. (lbs.)	Oak Price	Maple Price
<u>To Cover ONE UNIT</u>					
93-S10-S01 OAK	93-S10-S01 MAP	10"D, Single-Faced	11	\$312	\$327
93-S12-S01 OAK	93-S12-S01 MAP	12"D, Single-Faced	14	\$313	\$329
93-S20-S01 OAK	93-S20-S01 MAP	20"D, Double-Faced	23	\$438	\$459
93-S24-S01 OAK	93-S24-S01 MAP	24"D, Double-Faced	27	\$495	\$520
<u>To Cover TWO UNITS</u>					
93-S10-S02 OAK	93-S10-S02 MAP	10"D, Single-Faced	22	\$409	\$429
93-S12-S02 OAK	93-S12-S02 MAP	12"D, Single-Faced	28	\$435	\$456
93-S20-S02 OAK	93-S20-S02 MAP	20"D, Double-Faced	46	\$619	\$650
93-S24-S02 OAK	93-S24-S02 MAP	24"D, Double-Faced	54	\$776	\$815
<u>To Cover THREE UNITS</u>					
93-S10-S03 OAK	93-S10-S03 MAP	10"D, Single-Faced	33	\$535	\$561
93-S12-S03 OAK	93-S12-S03 MAP	12"D, Single-Faced	42	\$571	\$601
93-S20-S03 OAK	93-S20-S03 MAP	20"D, Double-Faced	69	\$780	\$819
93-S24-S03 OAK	93-S24-S03 MAP	24"D, Double-Faced	81	\$818	\$859
<u>To Cover FOUR UNITS</u>					
93-S10-S04 OAK	93-S10-S04 MAP	10"D, Single-Faced	44	\$822	\$864
93-S12-S04 OAK	93-S12-S04 MAP	12"D, Single-Faced	56	\$872	\$916
93-S20-S04 OAK	93-S20-S04 MAP	20"D, Double-Faced	92	\$1,164	\$1,222
93-S24-S04 OAK	93-S24-S04 MAP	24"D, Double-Faced	108	\$1,314	\$1,380
<u>To Cover FIVE UNITS</u>					
93-S10-S05 OAK	93-S10-S05 MAP	10"D, Single-Faced	55	\$942	\$890
93-S12-S05 OAK	93-S12-S05 MAP	12"D, Single-Faced	70	\$1,008	\$1,058
93-S20-S05 OAK	93-S20-S05 MAP	20"D, Double-Faced	115	\$1,398	\$1,468
93-S24-S05 OAK	93-S24-S05 MAP	24"D, Double-Faced	135	\$1,601	\$1,680
<u>To Cover SIX UNITS</u>					
93-S10-S06 OAK	93-S10-S06 MAP	10"D, Single-Faced	66	\$1,066	\$1,120
93-S12-S06 OAK	93-S12-S06 MAP	12"D, Single-Faced	84	\$1,149	\$1,206
93-S20-S06 OAK	93-S20-S06 MAP	20"D, Double-Faced	138	\$1,558	\$1,635
93-S24-S06 OAK	93-S24-S06 MAP	24"D, Double-Faced	162	\$1,642	\$1,724
<u>To Cover SEVEN UNITS</u>					
93-S10-S07 OAK	93-S10-S07 MAP	10"D, Single-Faced	77	\$1,355	\$1,423
93-S12-S07 OAK	93-S12-S07 MAP	12"D, Single-Faced	98	\$1,445	\$1,518
93-S20-S07 OAK	93-S20-S07 MAP	20"D, Double-Faced	161	\$2,014	\$2,115
93-S24-S07 OAK	93-S24-S07 MAP	24"D, Double-Faced	189	\$2,137	\$2,244
<u>To Cover EIGHT UNITS</u>					
93-S10-S08 OAK	93-S10-S08 MAP	10"D, Single-Faced	88	\$1,479	\$1,553
93-S12-S08 OAK	93-S12-S08 MAP	12"D, Single-Faced	112	\$1,580	\$1,659
93-S20-S08 OAK	93-S20-S08 MAP	20"D, Double-Faced	184	\$2,177	\$2,285
93-S24-S08 OAK	93-S24-S08 MAP	24"D, Double-Faced	216	\$2,419	\$2,540
<u>To Cover NINE UNITS</u>					
93-S10-S09 OAK	93-S10-S09 MAP	10"D, Single-Faced	99	\$1,604	\$1,684
93-S12-S09 OAK	93-S12-S09 MAP	12"D, Single-Faced	126	\$1,722	\$1,808
93-S20-S09 OAK	93-S20-S09 MAP	20"D, Double-Faced	207	\$2,338	\$2,455
93-S24-S09 OAK	93-S24-S09 MAP	24"D, Double-Faced	243	\$2,465	\$2,589

Note: Edge Band on long side only. Tops are designed to be inset between end panels. If edge bands are desired on short edges, please enter the part as a modification and specify which bands to be included.

To ensure that tops for steel shelving work with each manufacturer and top method, please specify the exact width and depth of tops. Add 15% for HPL on top and bottom (Steel Shelving ONLY).

Please specify Wood Finish (Table 1) and High-Pressure Laminate (Table 2). Details can be found on page GEN 4.

General Specifications

END PANELS: STEEL SHELVING

The end panels are 1-3/16" thick. The core is 45# density particleboard with grade A-A plain-sliced white maple veneer on both faces. The type matching of the veneers is slip-matched, tight side out. All four edges are externally banded with 1.6mm white maple. The end panels are supplied without machining or hardware for attachment. The outside face of the end panels receives three rows of black 1/2" design squares.

The number of design squares in each row are determined by the depth

of the panel. The squares are centered left to right and begin 3-3/4" down from the top edge of the panel.

End panels for steel shelving with continuous tops or canopy top inset are designed to have the canopy top "inset" between the end panels.

Note: Exact height and depth of panel must be specified when ordering.

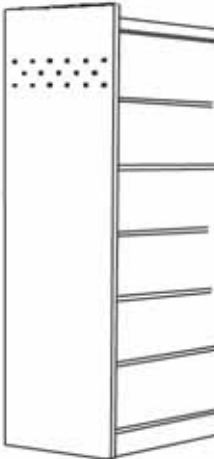
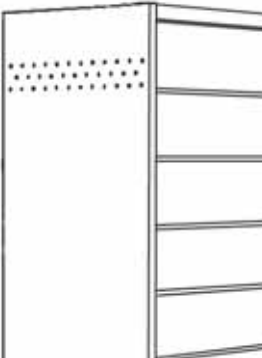
Oak Catalog No.	Maple Catalog No.	Description	Wt. (lbs.)	Oak Price	Maple Price	
93-702-MOD OAK	93-702-MOD MAP	43-3/4" x 13-7/8"	10	\$454	\$477	 <p>Single-Faced End Panels</p>
93-703-MOD OAK	93-703-MOD MAP	43-3/4" x 15-7/8"	12	\$470	\$493	
93-705-MOD OAK	93-705-MOD MAP	67-3/4" x 13-7/8"	16	\$553	\$580	
93-706-MOD OAK	93-706-MOD MAP	67-3/4" x 15-7/8"	19	\$560	\$588	
93-708-MOD OAK	93-708-MOD MAP	79-3/4" x 13-7/8"	15	\$575	\$604	
93-709-MOD OAK	93-709-MOD MAP	79-3/4" x 15-7/8"	24	\$582	\$611	
93-711-MOD OAK	93-711-MOD MAP	85-3/4" x 13-7/8"	18	\$582	\$611	
93-712-MOD OAK	93-712-MOD MAP	85-3/4" x 15-7/8"	27	\$592	\$622	
93-714-MOD OAK	93-714-MOD MAP	91-3/4" x 13-7/8"	20	\$592	\$622	
93-715-MOD OAK	93-715-MOD MAP	91-3/4" x 15-7/8"	29	\$599	\$629	
<hr/>						 <p>Double-Faced End Panels</p>
93-722-MOD OAK	93-722-MOD MAP	43-3/4" x 24-3/8"	20	\$565	\$593	
93-723-MOD OAK	93-723-MOD MAP	43-3/4" x 28-3/8"	24	\$574	\$602	
93-725-MOD OAK	93-725-MOD MAP	67-3/4" x 24-3/8"	32	\$709	\$744	
93-726-MOD OAK	93-726-MOD MAP	67-3/4" x 28-3/8"	38	\$724	\$760	
93-728-MOD OAK	93-728-MOD MAP	79-3/4" x 24-3/8"	30	\$731	\$768	
93-729-MOD OAK	93-729-MOD MAP	79-3/4" x 28-3/8"	48	\$792	\$831	
93-731-MOD OAK	93-731-MOD MAP	85-3/4" x 24-3/8"	36	\$736	\$773	
93-732-MOD OAK	93-732-MOD MAP	85-3/4" x 28-3/8"	54	\$750	\$788	
93-734-MOD OAK	93-734-MOD MAP	91-3/4" x 24-3/8"	40	\$750	\$788	
93-735-MOD OAK	93-735-MOD MAP	91-3/4" x 28-3/8"	58	\$761	\$799	

Please specify Wood Finish (Table 1). Details can be found on page GEN 4.

The Maxim Collection



2017 Price List and Specifications

Brodart Co. Contract Furniture - Made in USA

280 North Road, Clinton County Industrial Park • McElhattan, PA 17748

Toll-Free: 888-521-1884 • E-Mail: furniture@brodart.com • www.brodartfurniture.com

General Specifications

DESKTOP

Standard desktop is 1-3/16" thick, 3-ply, 45# density particleboard core, with a high-pressure laminate top surface .050" thick and a backing sheet .020" thick for balanced construction. The desk top receives a solid Northern-grown Red Oak or maple flush edge band 5/8" x 1-3/16" thick, radiused 7/8" to form a bullnose shape on the patron side. A 1/4", solid Northern-grown Red Oak or maple edge band is applied to the remaining three sides of the desk top, with top and bottom edges have a 1/8" radius. All edges are applied to the desktop after the laminate and backer sheets are applied, constituting an external edge band. Desktop is positioned over the end panels of the desk module, flush with the outside edges of the end panels.

END PANELS

Desk module end panel is 1" thick, 3-ply, 45# density particleboard core with select plain-sliced slip matched Northern-grown Red Oak or maple veneer on both sides. Exposed edges are externally banded with a 1" x 1.6mm thick solid, Northern-grown Red Oak or maple veneer edge band. The end panel and front panel are joined with 3/4" x 3/4" thick solid hardwood cleats screwed to the inside surface of the panel. Each end panel receives a 3" diameter egress grommet to provide for wire passage and two adjustable glides to allow leveling of the individual units.

FRONT PANEL

The front panel is 3/4" thick, 45# density particleboard core comprised of select rift cut Northern-grown Red Oak veneers or maple plain sliced slip matched veneers. Exposed edges are externally banded with a solid 3/4" x 1.6mm thick, veneer edge band. A 6"H x 3/4"D recessed, ebonized toe space is incorporated at the bottom of the panel. The front panel is positioned over the end panels of the desk module, flush with the outside edges of the end panels. Double wide units have two front panels to give the appearance of two individual units.

WORK SURFACE

Work surface is 1-3/16" thick, 3-ply, 45# density particleboard core, with a high-pressure laminate top surface .050" thick and a backing sheet .020" thick for balanced construction. The exposed edge receives a 1/4" thick, Northern-grown Red Oak or maple solid internal edge band in straight design. The back edge of the work surface has a plastic black strip, 1-1/2"W, which projects above the work surface 1/4" to act as a retainer. The work surface is 24-1/2"D and is positioned 1-1/2" away from the front panel, creating a cord drop space. Adjustable work surfaces positioned at heights of 36", 32" or 27" are available in single wide standing height desks.

Note: See Brodart optional electrical accessories for electrical power-distribution system for desk modules.

SHELVES

Shelves are constructed of 7-ply, furniture-grade veneer-core hardwood plywood, with Northern-grown Red Oak plain sliced face veneer or maple plain sliced face veneer. Exposed edges receive a 1.6mm thick, solid-oak or maple edge band.

DRAWERS

Drawers are constructed of solid Northern-grown Red Oak or maple with 1/4" thick wood bottom panel. Drawer has 3-ply particleboard fronts with select oak-face veneer or maple veneer. Box drawer has extension slides with 100# load capacity. File drawer has full-extension slides with 100# load capacity.

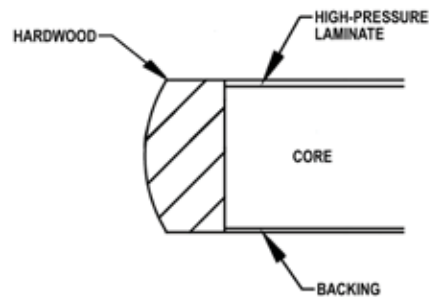

Maxim Series Flush Edge Band

DESK DIMENSIONS

Standing-Height Desk, overall:

39-3/16"H x 35"W x 30"D or 39-3/16"H x 70"W x 30"D.

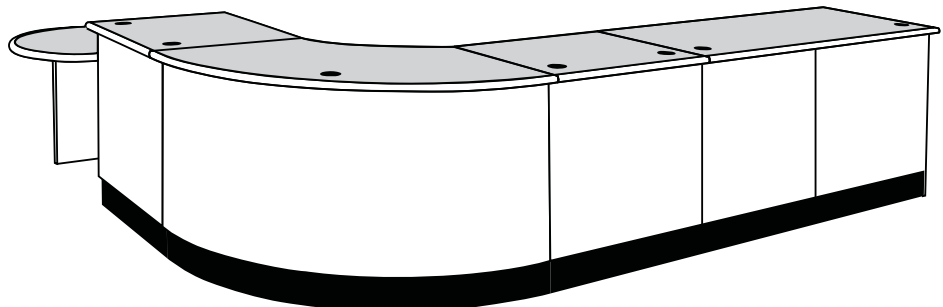

Sitting-Height Desk, overall:

32-3/16"H x 35"W x 30"D or 32-3/16"H x 70"W x 30"D.



Oak Catalog No.	Maple Catalog No.	Description	H x W x D	Wt. (lbs.)	Oak Price	Maple Price	Standing	Sitting
73-012-S00 OAK	73-012-S00 MAP	Standing Height Desk with Patron Service Ledge Inside dimensions: 33"W x 26-3/4"D. The 7-7/8" patron ledge is at a height of 39-3/16"H. Note: Adjustable-height work surface may be positioned at heights of 36", 32" or 27".	39-3/16" x 35" x 30"	140	\$2,654	\$2,893	Single-Wide Desk with Patron Service Ledge	
73-E12-S00 OAK	73-E12-S00 MAP	Sitting Height Desk with Patron Service Ledge Inside dimensions: 33"W x 26-3/4"D. The 7-7/8" patron ledge is at a height of 32-3/16"H. Note: Work surface is fixed at 27"H.	32-3/16" x 35" x 30"	125	\$2,522	\$2,748	Single-Wide Desk with Patron Service Ledge	
73-014-S00 OAK	73-014-S00 MAP	Standing Height Desk without Patron Service Ledge Inside dimensions: 33"W x 26-3/4"D. The work surface is at 39-3/16"H. Two 3" diameter grommets are located in the work surface.	39-3/16" x 35" x 30"	135	\$2,317	\$2,525	Single-Wide Desk without Patron Service Ledge	
73-E14-S00 OAK	73-E14-S00 MAP	Sitting Height Desk without Patron Service Ledge Inside dimensions: 33"W x 26-3/4"D. The work surface is at 32-3/16"H. Two 3" diameter grommets are located in the work surface.	32-3/16" x 35" x 30"	120	\$2,122	\$2,313	Single-Wide Desk without Patron Service Ledge	
73-015-S00 OAK	73-015-S00 MAP	Standing Height Book Return Unit Inside dimensions: 33"W x 26-3/4"D. The work surface is at 39-3/16"H. Unit has a 5"H x 12"W finished opening centered in the front panel for passage of books and a book chute to direct the books over a mobile depressible book truck. (Depressible book truck not included). Two 3" diameter grommets are located in the work surface.	39-3/16" x 35" x 30"	135	\$2,246	\$2,448	Book Return Unit	
73-E15-S00 OAK	73-E15-S00 MAP	Sitting Height Book Return Unit Inside dimensions: 33"W x 26-3/4"D. The work surface is at 32-3/16"H. Unit has a 5"H x 12"W finished opening centered in the front panel for passage of books and a book chute to direct the books over a mobile depressible book truck. (Depressible book truck not included). Two 3" diameter grommets are located in the work surface.	32-3/16" x 35" x 30"	120	\$2,114	\$2,305	Book Return Unit	

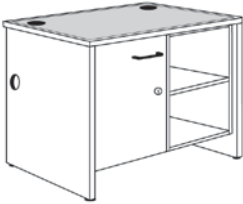
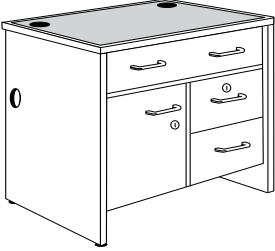

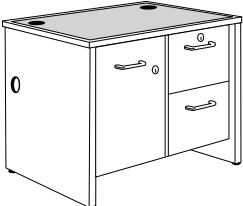
Please specify Wood Finish (Table 1) and High-Pressure Laminate (Table 2). Details can be found on page GEN 4.

Standing	Sitting	Oak Catalog No.	Maple Catalog No.	Description	H x W x D	Wt. (lbs.)	Oak Price	Maple Price
Cupboard and Open Shelf		73-121-S00 OAK	73-121-S00 MAP	Standing Height Cupboard and Open Shelf This unit has one fixed and two adjustable shelves. A hidden drawer is positioned above the lockable storage compartment. Two 3" diameter grommets are located in the work surface.	39-3/16" x 35" x 30"	175	\$4,415	\$4,813
		73-E21-S00 OAK	73-E21-S00 MAP	Sitting Height Cupboard This unit has one fixed and one adjustable shelf. A hidden drawer is positioned above the lockable storage compartment. Two 3" diameter grommets are located in the work surface.	32-3/16" x 35" x 30"	160	\$4,127	\$4,498
								
Full Width Drawer, Cupboard and Drawers		73-122-S00 OAK	73-122-S00 MAP	Standing Height Full Width Drawer, Cupboard and Drawers This unit has one full-width drawer, two file drawers, and a lockable storage compartment. Two 3" diameter grommets are located in the work surface. Note: Available in 39"H only.	39-3/16" x 35" x 30"	225	\$6,048	\$6,593
								
Cupboard and Drawer Unit		73-123-S00 OAK	73-123-S00 MAP	Standing Height Cupboard and Drawer Unit This unit has one locking box drawer and two file drawers. Cupboard section has two adjustable shelves and locking door on hinges. Two 3" diameter grommets are located in the work surface.	39-3/16" x 35" x 30"	225	\$5,355	\$5,837
		73-E23-S00 OAK	73-E23-S00 MAP	Sitting Height Cupboard and Drawer Unit This unit has one locking file drawer and one file drawer. Cupboard section has one adjustable shelf and locking door on hinges. Two 3" diameter grommets are located in the work surface.	32-3/16" x 35" x 30"	205	\$4,878	\$5,316
								

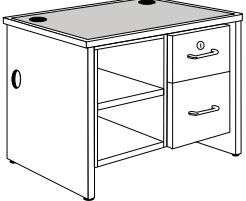
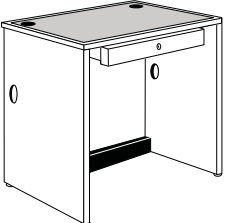
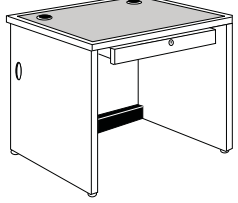
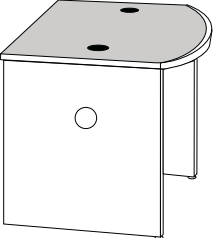
Please specify Wood Finish (Table 1) and High-Pressure Laminate (Table 2). Details can be found on page GEN 4.

Oak Catalog No.	Maple Catalog No.	Description	H x W x D	Wt. (lbs.)	Oak Price	Maple Price	Standing	Sitting
73-124-S00 OAK	73-124-S00 MAP	<p>Standing Height Open Shelf and Drawer Unit</p> <p>This unit has one lockable box drawer and two file drawers. Shelf section has two adjustable shelves, and one fixed base shelf. Two 3" diameter grommets are located in the work surface.</p>	39-3/16" x 35" x 30"	200	\$4,942	\$5,387	Open Shelf and Drawer Unit	
								
73-E24-S00 OAK	73-E24-S00 MAP	<p>Sitting Height Open Shelf and Drawer Unit</p> <p>This unit has one lockable box drawer and one file drawer. Shelf section has one adjustable shelf, and one fixed base shelf. Two 3" diameter grommets are located in the work surface.</p>	32-3/16" x 35" x 30"	125	\$4,510	\$4,916		
								
73-131-S00 OAK	73-131-S00 MAP	<p>Standing Height Cash Drawer Unit</p> <p>Inside dimensions: 33"W x 26-3/4"D. The work surface is at 39-3/16"H. Desk has locking drawer with a coin and currency tray. Two 3" diameter grommets are located in the work surface.</p>	39-3/16" x 35" x 30"	150	\$3,359	\$3,662		Cash Drawer Unit
								
73-E31-S00 OAK	73-E31-S00 MAP	<p>Sitting Height Cash Drawer Unit</p> <p>Inside dimensions: 33"W x 26-3/4"D. The work surface is at 32-3/16"H. Desk has locking drawer with a coin and currency tray. Two 3" diameter grommets are located in the work surface.</p>	32-3/16" x 35" x 30"	135	\$3,216	\$3,505		
								
73-E32-S00 OAK	73-E32-S00 MAP	<p>Sitting Height ADA Station</p> <p>The ADA transaction station is designed to provide wheelchair access on the patrons' side. The knee space depth on the patrons' side is 22-1/4" and on the staff side is 16". Two 3" diameter grommets are located in the work surface. One 3-1/2" diameter egress with sleeve is located in each end panel for wire passage.</p>	32-3/16" x 35" x 40-1/2"	185	\$2,522	\$2,748		ADA Station
								

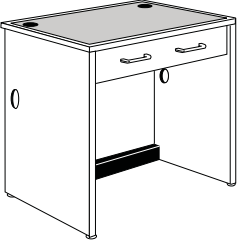
Please specify Wood Finish (Table 1) and High-Pressure Laminate (Table 2). Details can be found on page GEN 4.

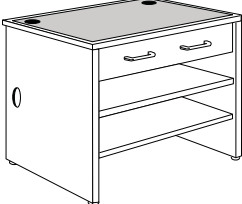
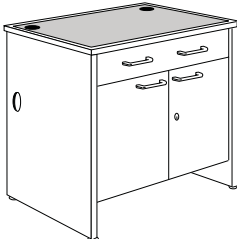
Standing	Sitting	Oak Catalog No.	Maple Catalog No.	Description	H x W x D	Wt. (lbs.)	Oak Price	Maple Price
		73-133-S00 OAK	73-133-S00 MAP	Standing Height Full Width Drawer Unit This drawer unit has a full-width drawer 10"H x 33"W x 18-3/4"D. Two 3" diameter grommets are located in the work surface. Note: Available in 39" H only.	39-3/16" x 35" x 30"	160	\$3,455	\$3,765
								
		73-134-S00 OAK	73-134-S00 MAP	Standing Height Full Width Drawer and Open Shelves This unit has a full-width drawer 10"H x 33"W x 18-3/4"D. Also, one fixed and one adjustable, full-depth shelf. Two 3" diameter grommets are located in the work surface.	39-3/16" x 35" x 30"	180	\$3,264	\$3,558
								
		73-E34-S00 OAK	73-E34-S00 MAP	Sitting Height Full Width Drawer and Open Shelves This unit has a full-width drawer 10"H x 33"W x 18-3/4"D. Also, one fixed and one adjustable, full-depth shelf. Two 3" diameter grommets are located in the work surface.	32-3/16" x 35" x 30"	165	\$3,072	\$3,349
								
		73-135-S00 OAK	73-135-S00 MAP	Standing Height Full Width Drawer and Cupboard Unit This unit has a full-width drawer 10"H x 33"W x 18-3/4"D. Also, one fixed and one adjustable, full-depth shelf. Hinged doors have a catch, lock and door pulls. Two 3" diameter grommets are located in the work surface.	39-3/16" x 35" x 30"	220	\$3,841	\$4,187
								

Please specify Wood Finish (Table 1) and High-Pressure Laminate (Table 2). Details can be found on page GEN 4.

Oak Catalog No.	Maple Catalog No.	Description	H x W x D	Wt. (lbs.)	Oak Price	Maple Price	Standing	Sitting
73-172-S00 OAK	73-172-S00 MAP	<p>Standing Height Discharge Unit</p> <p>These units have a full-width well with seven removable wood trays for 5"H x 3"W cards. The 7-7/8" patron ledge is at a height of 39-3/16"H.</p> <p>Note: Standing-height roll unders do not work with this unit.</p>	39-3/16" x 35" x 30"	165	\$3,612	\$3,937		Discharge Unit
73-E72-S00 OAK	73-E72-S00 MAP	<p>Sitting Height Discharge Unit</p> <p>These units have a full-width well with seven removable wood trays for 5"H x 3"W cards. The 7-7/8" patron ledge is at a height of 32-3/16"H.</p>	32-3/16" x 35" x 30"	145	\$3,418	\$3,725		
73-174-S00 OAK	73-174-S00 MAP	<p>Standing Height Open Shelf Unit</p> <p>This unit has a full-depth fixed base shelf and two full-depth adjustable shelves. Two 3" diameter grommets are located in the work surface.</p>	39-3/16" x 35" x 30"	175	\$2,689	\$2,931		Open Shelf Unit
73-E74-S00 OAK	73-E74-S00 MAP	<p>Sitting Height Open Shelf Unit</p> <p>This unit has a full-depth fixed base shelf and two full-depth adjustable shelves. Two 3" diameter grommets are located in the work surface.</p>	32-3/16" x 35" x 30"	155	\$2,401	\$2,616		
73-176-S00 OAK	73-176-S00 MAP	<p>Standing Height Cupboard Unit</p> <p>This unit has a full-depth fixed base shelf and two full-depth adjustable shelves. Hinged doors have a catch, lock and door pulls. Two 3" diameter grommets are located in the work surface.</p>	39-3/16" x 35" x 30"	200	\$3,340	\$3,640		Cupboard Unit
73-E76-S00 OAK	73-E76-S00 MAP	<p>Sitting Height Cupboard Unit</p> <p>This unit has a full-depth fixed base shelf and one full-depth adjustable shelf. Hinged doors have a catch, lock and door pulls. Two 3" diameter grommets are located in the work surface.</p>	32-3/16" x 35" x 30"	180	\$3,187	\$3,474		

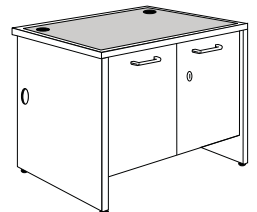
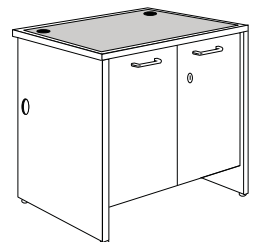
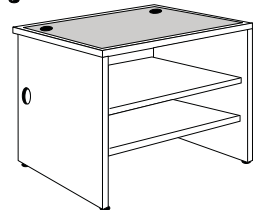
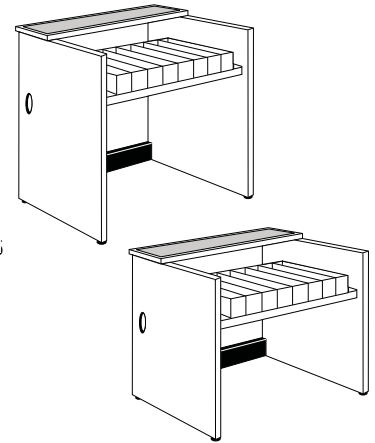



Please specify Wood Finish (Table 1) and High-Pressure Laminate (Table 2). Details can be found on page GEN 4.

Standing	Sitting	Oak Catalog No.	Maple Catalog No.	Description	H x W x D	Wt. (lbs.)	Oak Price	Maple Price
		73-236-S00 OAK	73-236-S00 MAP	Standing Height Media Storage Unit This unit has four full-width drawers 8-1/2"H x 33"W x 24"D with each containing five compartments for media storage.	39-3/16" x 35" x 30"	225	\$4,613	\$5,028
		73-E36-S00 OAK	73-E36-S00 MAP	Sitting Height Media Storage Unit This unit has three full-width drawers 8-1/2"H x 33"W x 24"D with each containing five compartments for media storage.	32-3/16" x 35" x 30"	205	\$4,240	\$4,621

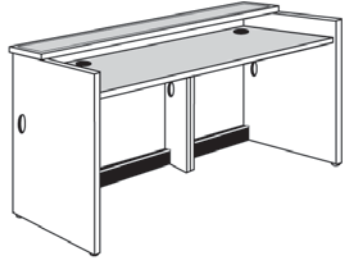

Please specify Wood Finish (Table 1) and High-Pressure Laminate (Table 2). Details can be found on page GEN 4.

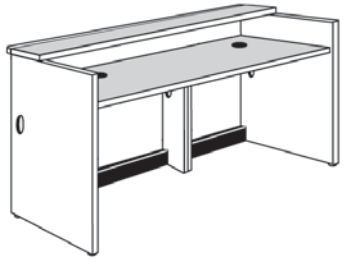
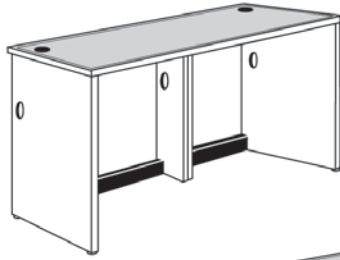
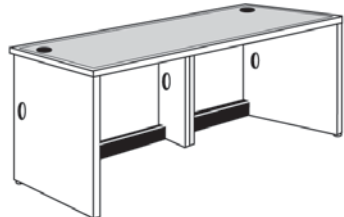
Oak Catalog No.	Maple Catalog No.	Description	H x W x D	Wt. (lbs.)	Oak Price	Maple Price	Standing	Sitting
73-011-S00 OAK	73-011-S00 MAP	Standing Height Double-Wide Desk with Patron Service Ledge Work Surface at 35"H Inside dimensions are 68"W x 26-3/4"D. The 7-7/8"D patron ledge is at a height of 39-3/16". Two 3" diameter grommets are located in the work surface. Note: Standing-height roll unders do not work with this unit.	39-3/16" x 70" x 30"	245	\$3,839	\$4,185		Double-Wide Desk with Patron Service Ledge,
								
73-E11-S00 OAK	73-E11-S00 MAP	Sitting Height Double-Wide Desk with Patron Service Ledge Work Surface at 28"H Inside dimensions are 68"W x 26-3/4"D. The 7-7/8"D patron ledge is at a height of 32-3/16". Two 3" diameter grommets are located in the work surface.	32-3/16" x 70" x 30"	210	\$3,621	\$3,947		
								
73-011-SEA OAK	73-011-SEA MAP	Standing Height Double-Wide Desk with Patron Service Ledge Work Surface at 28"H Inside dimensions are 68"W x 26-3/4"D. The 7-7/8"D patron ledge is at a height of 39-3/16". Two 3" diameter grommets are located in the work surface. Note: Standing-height roll unders do not work with this unit.	39-3/16" x 70" x 30"	245	\$3,742	\$4,079		
								
73-013-S00 OAK	73-013-S00 MAP	Standing Height Double-Wide Desk without Patron Service Ledge Inside dimensions are 68"W x 26-3/4"D. The work surface is at 39-3/16" H. Two 3" diameter grommets are located in the work surface.	39-3/16" x 70" x 30"	230	\$3,411	\$3,717		Double-Wide Desk without Patron Service Ledge
								
73-E13-S00 OAK	73-E13-S00 MAP	Sitting Height Double-Wide Desk without Patron Service Ledge Inside dimensions are 68"W x 26-3/4"D. The work surface is at 32-3/16" H. Two 3" diameter grommets are located in the work surface.	32-3/16" x 70" x 30"	195	\$3,240	\$3,532		
								

Please specify Wood Finish (Table 1) and High-Pressure Laminate (Table 2). Details can be found on page GEN 4.

Standing	Sitting	Oak Catalog No.	Maple Catalog No.	Description	H x W x D	Wt. (lbs.)	Oak Price	Maple Price
Double-Wide Work Desk	Double Pedestal	73-E37-S00 OAK	73-E37-S00 MAP	Sitting Height Double-Wide Double Pedestal Work Desk	32-3/16" x 70" x 30"	260	\$7,872	\$8,580

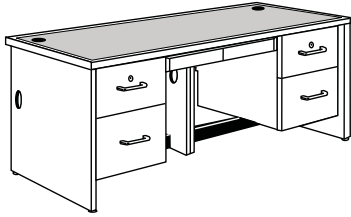

Inside dimensions are 68"W x 26-3/4"D.
 This unit has two drawer pedestals, one mounted on each side consisting of one locking drawer at top; one file drawer with hanging file rack at bottom. Two center drawers are mounted between the two pedestals. Two 3" diameter grommets are located in the work surface.
Note: Available in 32-3/16" H only.

Double-Wide Work Desk	Single Pedestal	73-138-S00 OAK	73-138-S00 MAP	Standing Height Double-Wide Single Pedestal Work Desk	39-3/16" x 70" x 30"	230	\$5,183	\$5,650
--------------------------	-----------------	----------------	----------------	--	----------------------	-----	---------	---------



Inside dimensions are 68"W x 26-3/4"D.
 This unit has one drawer pedestal mounted on the left side consisting of one locking drawer at top; two file drawers with Pendaflex hangers at the bottom. Two 3" diameter grommets are located in the work surface.



73-E38-S00 OAK 73-E38-S00 MAP



Sitting Height Double-Wide Single Pedestal Work Desk		73-E38-S00 OAK	73-E38-S00 MAP		32-3/16" x 70" x 30"	195	\$4,896	\$5,337
---	--	----------------	----------------	--	----------------------	-----	---------	---------

Inside dimensions are 68"W x 26-3/4"D.
 This unit has one drawer pedestal mounted on the left side consisting of one locking file drawer at top; one file drawer at the bottom, both with hanging file racks. Two 3" diameter grommets are located in the work surface.

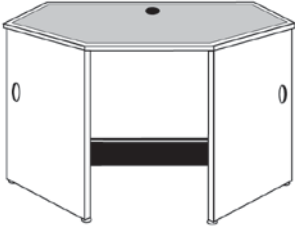

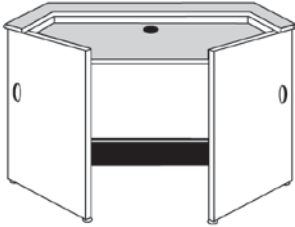
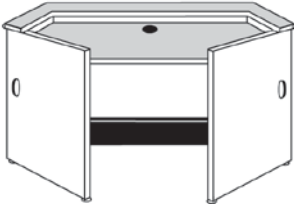
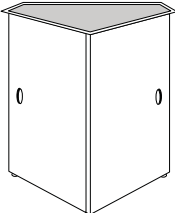
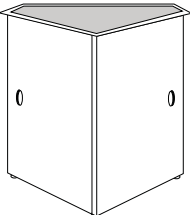
Please specify Wood Finish (Table 1) and High-Pressure Laminate (Table 2). Details can be found on page GEN 4.

Oak Catalog No.	Maple Catalog No.	Description	H x W x D	Wt. (lbs.)	Oak Price	Maple Price	Standing	Sitting
73-010-S00 OAK	73-010-S00 MAP	Standing Height 90 Degree Multi-Purpose Corner Unit has 29-5/16" W port area. Storage shelves are located in the two angled areas to the left and right of the desk module. One 3" diameter grommet is located in the work-surface top. One 3-1/2" diameter egress with sleeve is located in each end panel for wire passage.	39-3/16" x 71-3/4" x 30"	250	\$5,013	\$5,464		90 Degree Multi-Purpose Corner
								
73-E10-S00 OAK	73-E10-S00 MAP	Sitting Height 90 Degree Multi-Purpose Corner Unit has 29-5/16" W port area. Storage shelves are located in the two angled areas to the left and right of the desk module. One 3" diameter grommet is located in the work-surface top. One 3-1/2" diameter egress with sleeve is located in each end panel for wire passage.	32-3/16" x 71-3/4" x 30"	215	\$4,797	\$5,228		
								
73-017-S00 OAK	73-017-S00 MAP	Standing Height 90 Degree Multi-Purpose with Patron Service Ledge Unit has 29-5/16" W port area. The 7-7/8" D patron ledge is at a height of 39-3/16". Work surface is at 35" H. Storage shelves are located in the two angled areas to the left and right of the module. One 3" diameter grommet is located in the work surface top. One 3-1/2" diameter egress with sleeve is located in each end panel for wire passage.	39-3/16" x 71-3/4" x 30"	245	\$6,513	\$7,099		90 Degree Multi-Purpose Corner with Patron Service Ledge
								
73-E17-S00 OAK	73-E17-S00 MAP	Sitting Height 90 Degree Multi-Purpose with Patron Service Ledge Unit has 29-5/16" W port area. The 7-7/8" D patron ledge is at a height of 32-3/16". Work surface is at 28" H. Storage shelves are located in the two angled areas to the left and right of the module. One 3" diameter grommet is located in the work surface top. One 3-1/2" diameter egress with sleeve is located in each end panel for wire passage.	32-3/16" x 71-3/4" x 30"	210	\$6,239	\$6,801		
								
73-016-S00 OAK	73-016-S00 MAP	Standing Height 90 Degree Closed Corner Unit This 90 degree unit is used to form a right angle turn in a desk arrangement. This is not available with patron ledge. One 3-1/2" diameter egress is located in each end panel for wire passage through a continuous ABS tube.	39-3/16" H	140	\$2,680	\$2,921		90 Degree Closed Corner Unit
								
73-E16-S00 OAK	73-E16-S00 MAP	Sitting Height 90 Degree Closed Corner Unit This 90 degree unit is used to form a right angle turn in a desk arrangement. This is not available with patron ledge. One 3-1/2" diameter egress is located in each end panel for wire passage through a continuous ABS tube.	32-3/16" H	120	\$2,550	\$2,779		
								

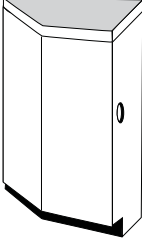
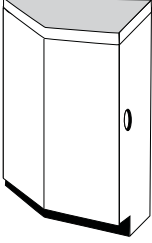
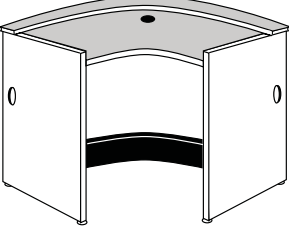
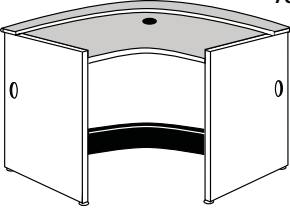
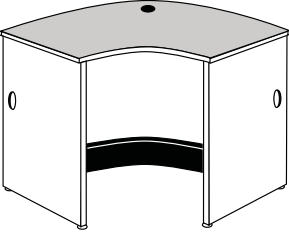
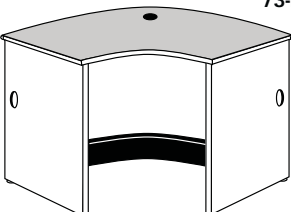
Please specify Wood Finish (Table 1) and High-Pressure Laminate (Table 2). Details can be found on page GEN 4.

Standing	Sitting	Oak Catalog No.	Maple Catalog No.	Description	H x W x D	Wt. (lbs.)	Oak Price	Maple Price
		73-018-S00 OAK	73-018-S00 MAP	Standing Height 45 Degree Closed Corner Unit This corner unit is used to create a 45 degree angle in the circulation desk. This unit is not available with a patron ledge.	39-3/16" x 22-7/8" x 30"	130	\$2,490	\$2,715
		73-E18-S00 OAK	73-E18-S00 MAP	Sitting Height 45 Degree Closed Corner Unit This corner unit is used to create a 45 degree angle in the circulation desk. This unit is not available with a patron ledge.	32-3/16" x 22-7/8" x 30"	110	\$2,358	\$2,570
90 Degree Open Curved Corner with Patron Service Ledge		73-040-S00 OAK	73-040-S00 MAP	Standing Height 90 Degree Open Curved Corner with Patron Service Ledge The 7-7/8"D patron ledge is at a height of 39-3/16". The work surface is at 35"H. Unit has 26-5/8"W port area. Storage shelves are located in the two angled areas to the left and right of the desk module. One 3" diameter grommet is located in the work surface top. One 3-12" diameter egress with sleeve is located in each end panel for wire passage.	39-3/16" x 70-1/8" x 30"	245	\$8,125	\$8,856
		73-E40-S00 OAK	73-E40-S00 MAP	Sitting Height 90 Degree Open Curved Corner with Patron Service Ledge The 7-7/8"D patron ledge is at a height of 32-3/16". The work surface is at 35"H. Unit has 26-5/8"W port area. Storage shelves are located in the two angled areas to the left and right of the desk module. One 3" diameter grommet is located in the work surface top. One 3-12" diameter egress with sleeve is located in each end panel for wire passage.	32-3/16" x 70-1/8" x 30"	210	\$7,826	\$8,530
90 Degree Open Curved Corner		73-041-S00 OAK	73-041-S00 MAP	Standing Height 90 Degree Open Curved Corner Work surface is at 39-3/16"H. Unit has 26-5/8"W port area. Storage shelves are located in the two angled areas to the left and right of the desk module. One 3" diameter grommet is located in the work-surface top. One 3-1/2" diameter egress with sleeve is located in each end panel for wire passage.	39-3/16" x 70-1/8" x 30"	245	\$7,165	\$7,809
		73-E41-S00 OAK	73-E41-S00 MAP	Sitting Height 90 Degree Open Curved Corner Work surface is at 32-3/16"H. Unit has 26-5/8"W port area. Storage shelves are located in the two angled areas to the left and right of the desk module. One 3" diameter grommet is located in the work-surface top. One 3-1/2" diameter egress with sleeve is located in each end panel for wire passage.	32-3/16" x 70-1/8" x 30"	210	\$6,899	\$7,520

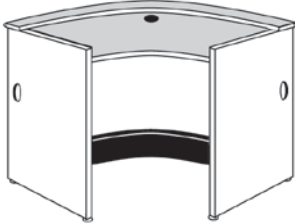
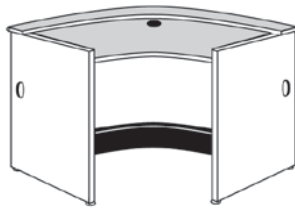
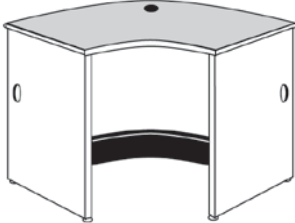
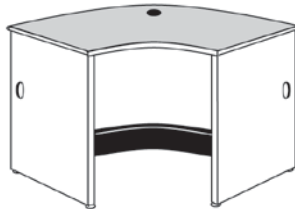
Please specify Wood Finish (Table 1) and High-Pressure Laminate (Table 2). Details can be found on page GEN 4.

Oak Catalog No.	Maple Catalog No.	Description	H x W x D	Wt. (lbs.)	Oak Price	Maple Price	Standing	Sitting
73-047-S00 OAK	73-047-S00 MAP	Standing Height 60 Degree Curved Corner with Patron Service Ledge The 7-7/8"D patron ledge is at a height of 39-3/16". The work surface is at 35-7/16"H. Unit has 49-1/16" W port area. Storage shelves are located in the two angled areas to the left and right of the desk module. One 3" diameter grommet is located in the work surface top. One 3-1/2" diameter egress with sleeve is located in each end panel for wire passage.	39-3/16" x 80-3/4" x 30"	245	\$9,785	\$10,665	60 Degree Curved Corner with Patron Service Ledge	
								
73-E47-S00 OAK	73-E47-S00 MAP	Sitting Height 60 Degree Curved Corner with Patron Service Ledge The 7-7/8"D patron ledge is at a height of 32-3/16". The work surface is at 28"H. Unit has 49-1/16" W port area. Storage shelves are located in the two angled areas to the left and right of the desk module. One 3" diameter grommet is located in the work surface top. One 3-1/2" diameter egress with sleeve is located in each end panel for wire passage.	32-3/16" x 80-3/4" x 30"	210	\$9,434	\$10,283		
								
73-048-S00 OAK	73-048-S00 MAP	Standing Height 60 Degree Curved Corner Work surface is at 39-3/16"H. Unit has 49-1/16"W port area. Storage shelves are located in the two angled areas to the left and right of the desk module. One 3" diameter grommet is located in the work surface top. One 3-1/2" diameter egress with sleeve is located in each end panel for wire passage.	39-3/16" x 80-3/4" x 30"	245	\$8,843	\$9,638	60 Degree Curved Corner	
								
73-E48-S00 OAK	73-E48-S00 MAP	Sitting Height 60 Degree Curved Corner Work surface is at 32-3/16"H. Unit has 49-1/16"W port area. Storage shelves are located in the two angled areas to the left and right of the desk module. One 3" diameter grommet is located in the work surface top. One 3-1/2" diameter egress with sleeve is located in each end panel for wire passage.	32-3/16" x 80-3/4" x 30"	210	\$8,533	\$9,301		
								
73-055-S00 OAK	73-055-S00 MAP	Standing Height 90 Degree Closed Corner Unit This 90 degree unit is used to form a right-angle turn in a desk arrangement. This unit is provided with a curved front panel.	39-3/16"H x 30"D	140	\$3,464	\$3,776	90 Degree Curved Closed Corner Unit	
								
73-E55-S00 OAK	73-E55-S00 MAP	Sitting Height 90 Degree Closed Corner Unit This 90 degree unit is used to form a right-angle turn in a desk arrangement. This unit is provided with a curved front panel.	32-3/16"H x 30"D	120	\$3,236	\$3,527		
								

Please specify Wood Finish (Table 1) and High-Pressure Laminate (Table 2). Details can be found on page GEN 4.

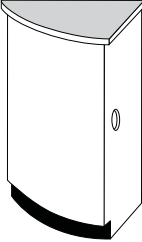
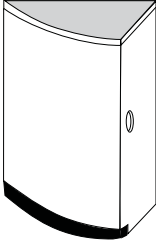
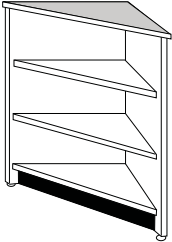
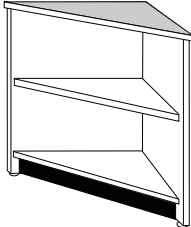
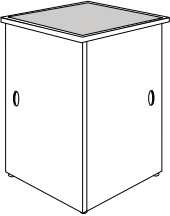
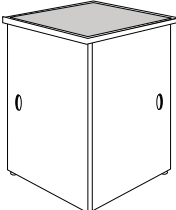
Standing	Sitting	Oak Catalog No.	Maple Catalog No.	Description	H x W x D	Wt. (lbs.)	Oak Price	Maple Price
45 Degree Curved Closed Corner Unit		73-058-S00 OAK	73-058-S00 MAP	Standing Height 45 Degree Curved Closed Corner Unit This unit is used to create a 45 degree angle in the circulation desk. It is not available with patron ledge.	39-3/16" x 22-3/8" x 30"	130	\$3,167	\$3,452
		73-E58-S00 OAK	73-E58-S00 MAP	Sitting Height 45 Degree Curved Closed Corner Unit This unit is used to create a 45 degree angle in the circulation desk. It is not available with patron ledge.	32-3/16" x 22-3/8" x 30"	110	\$2,938	\$3,203
90 Degree Open Corner Shelf		73-143-S00 OAK	73-143-S00 MAP	Standing Height 90 Degree Open Corner Shelf This 90 degree unit is used to form a right-angle turn in a desk arrangement. Has one fixed base shelf and two adjustable shelves. Note: Units must be modified on a project by project basis for electrical pass-through on open corner units.	39-3/16"H x 30"D	140	\$2,464	\$2,686
		73-E43-S00 OAK	73-E43-S00 MAP	Sitting Height 90 Degree Open Corner Shelf This 90 degree unit is used to form a right-angle turn in a desk arrangement. Has one fixed base shelf and two adjustable shelves. Note: Units must be modified on a project by project basis for electrical pass-through on open corner units.	32-3/16"H x 30"D	120	\$2,281	\$2,486
90 Degree Square Corner Unit		73-150-S00 OAK	73-150-S00 MAP	Standing Height 90 Degree Square Corner Unit This square corner unit is used to form a right angle in a desk arrangement. One 3" diameter egress is located in each end panel for wire passage through a continuous ABS tube.	39-3/16" x 30" x 30"	160	\$2,667	\$2,906
		73-E50-S00 OAK	73-E50-S00 MAP	Sitting Height 90 Degree Square Corner Unit This square corner unit is used to form a right angle in a desk arrangement. One 3" diameter egress is located in each end panel for wire passage through a continuous ABS tube.	32-3/16" x 30" x 30"	140	\$2,514	\$2,740

Please specify Wood Finish (Table 1) and High-Pressure Laminate (Table 2). Details can be found on page GEN 4.

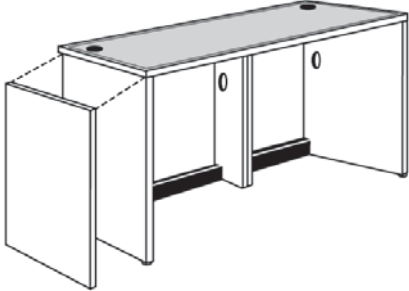
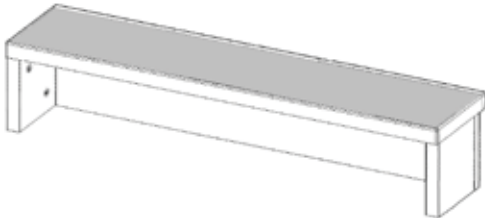
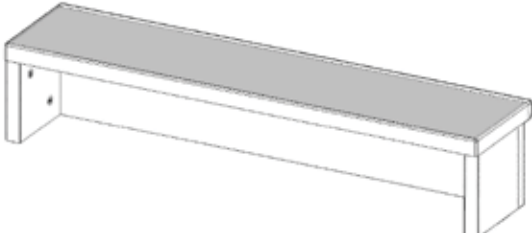
Oak Catalog No.	Maple Catalog No.	Description	H x W x D	Wt. (lbs.)	Oak Price	Maple Price	
73-178-S00 OAK	73-178-S00 MAP	Detachable End Panels (Pair) End panels are 1" thick, 3-ply, 45# density particleboard core with plain-sliced oak or maple veneers. Exposed edges are externally banded with 1.6mm thick, solid Northern-grown Oak or maple edge band.	37-1/2" x 1" x 26-3/4"	52	\$1,027	\$1,119	Detachable End Panels (Pair) 
73-E78-S00 OAK	73-E78-S00 MAP	Detachable End Panels (Pair) End panels are 1" thick, 3-ply, 45# density particleboard core with plain-sliced oak or maple veneers. Exposed edges are externally banded with 1.6mm thick, solid Northern-grown Oak or maple edge band.	30-1/2" x 1" x 26-3/4"	42	\$980	\$1,068	
73-196-S00 OAK	73-196-S00 MAP	Single-Wide Add On 7"H Patron Ledge Unit is designed to be added onto a single wide desk without a patron ledge. The Patron Ledge Assembly will attach to the desktop by means of #8 x 2-1/2" screws inserted through the work surface into the ledge assembly.	7" x 35" x 7-7/8"	10	\$509	\$556	Single-Wide Add On 7"H Patron Ledge 
73-197-S00 OAK	73-197-S00 MAP	Double-Wide Add On 7"H Patron Ledge Unit is designed to be added onto a double wide desk without a patron ledge. The Patron Ledge Assembly will attach to the desktop by means of #8 x 2-1/2" screws inserted through the work surface into the ledge assembly.	7" x 70" x 7-7/8"	20	\$644	\$702	Double-Wide Add On 7"H Patron Ledge 

Please specify Wood Finish (Table 1) and High-Pressure Laminate (Table 2). Details can be found on page GEN 4.

The Quorum 94T Collection



2017 Price List and Specifications

Brodart Co. Contract Furniture - Made in USA

280 North Road, Clinton County Industrial Park • McElhattan, PA 17748

Toll-Free: 888-521-1884 • E-Mail: furniture@brodart.com • www.brodartfurniture.com

General Specifications

TABLETOP – 94T Series

Standard tabletops are 1-3/16" thick, 5-ply solid plywood or 1-3/16" thick particleboard core, including a top surface of .050" thick, high-pressure laminate with a backing sheet not less than .020" thick for balanced construction. High-pressure laminate has a lo-glare finish resistant to scratches, fading, and staining that meets or exceeds NEMA standards. Edges are solid Northern-grown red oak. Drop edge band is 5/8" thick x 1-5/8", externally banded to form a bullnose with a 1/4" radius at corners.

APRON (OPTIONAL)

A 1-3/4"W x 25/32" Northern-grown red oak apron is fitted between the legs and behind the extended tabletop edge band. A 1/4" styling line, routed into the apron, highlights the tabletop and legs. The bottom edge and both ends of each apron receive a 1/2" radius.

Aprons on round tables are fitted between the legs and follow the curvature of the edge band. (Aprons are an optional feature on 94T Series tables).

LEGS

Legs are glued up, 2-1/4" square solid Northern-grown red oak. All vertical edges of legs receive a 1/2" radius. Bottom edges of legs are radiused 1/8". Each leg has a 2" diameter, adjustable glide mounted in a recessed tee-nut. The glide is further recessed into the leg by means of a counter-sunk boring which accepts the upper two-thirds of the glide.

Legs attach to tabletops by means of a 5" square x 5/16" thick steel plate. The plate is attached to the leg by a 5/16" x 2-1/2" machine bolt engaging a 5/8" diameter barrel nut inserted into the leg. The steel plate is attached to the tabletop by five 5/16" x 1" machine bolts engaging internally and externally threaded bushings in the underside of the tabletop. Leg plates are positioned behind, and be hidden by, the extended table edge band.

TABLETOP SUPPORT

For maximum rigidity, rectangular tables 60" or more wide receive a V-shaped, 14-gauge steel keel securely fastened to the underside of the tabletop. Tables 48"D and more than 60"W, receive two steel keels parallel to the length of the table. Tables 90" or wider receive two extra legs located under the center of the table to provide added support.

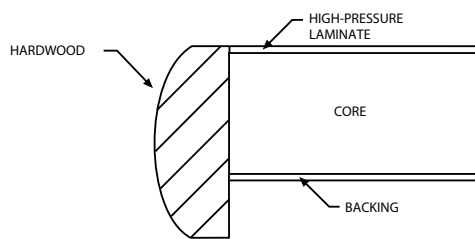
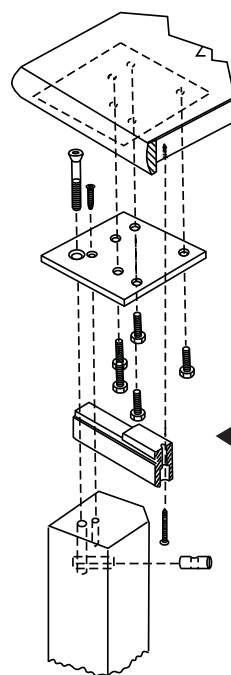

94T Series Drop Edge

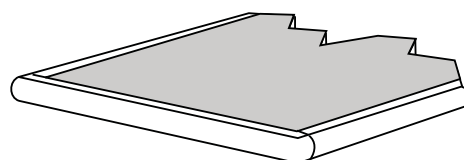

94T Series
External Edge Band

Plywood Core Catalog No.	Particleboard Core Catalog No.	Description	H x W x D	Wt. (lbs.)	Plywood Core Price	Particleboard Core Price
Round Oak Table						
94T-109-S00 OAK	94T-109-S02 OAK	Adult Table	29"H x 36" Diameter	100	\$1,563	\$1,372
94T-Y09-S00 OAK	94T-Y09-S02 OAK	Youth Table	27-1/2"H x 36" Diameter	100	\$1,563	\$1,372
94T-J09-S00 OAK	94T-J09-S02 OAK	Juvenile Table	25"H x 36" Diameter	100	\$1,563	\$1,372
94T-129-S00 OAK	94T-129-S02 OAK	Adult Table	29"H x 42" Diameter	110	\$1,696	\$1,504
94T-Y29-S00 OAK	94T-Y29-S02 OAK	Youth Table	27-1/2"H x 42" Diameter	110	\$1,696	\$1,504
94T-J29-S00 OAK	94T-J29-S02 OAK	Juvenile Table	25"H x 42" Diameter	110	\$1,696	\$1,504
94T-141-S00 OAK	94T-141-S02 OAK	Adult Table	29"H x 48" Diameter	120	\$1,696	\$1,504
94T-Y41-S00 OAK	94T-Y41-S02 OAK	Youth Table	27-1/2"H x 48" Diameter	120	\$1,696	\$1,504
94T-J41-S00 OAK	94T-J41-S02 OAK	Juvenile Table	25"H x 48" Diameter	120	\$1,696	\$1,504
N/A	94T-130-S02 OAK	Adult Table	29"H x 60" Diameter	140	N/A	\$2,003
N/A	94T-Y30-S02 OAK	Youth Table	27-1/2"H x 60" Diameter	140	N/A	\$2,003
N/A	94T-J30-S02 OAK	Juvenile Table	25"H x 60" Diameter	140	N/A	\$2,003
Round Maple Table						
94T-109-S00 MAP	94T-109-S02 MAP	Adult Table	29"H x 36" Diameter	100	\$1,703	\$1,494
94T-Y09-S00 MAP	94T-Y09-S02 MAP	Youth Table	27-1/2"H x 36" Diameter	100	\$1,703	\$1,494
94T-J09-S00 MAP	94T-J09-S02 MAP	Juvenile Table	25"H x 36" Diameter	100	\$1,703	\$1,494
94T-129-S00 MAP	94T-129-S02 MAP	Adult Table	29"H x 42" Diameter	110	\$1,848	\$1,639
94T-Y29-S00 MAP	94T-Y29-S02 MAP	Youth Table	27-1/2"H x 42" Diameter	110	\$1,848	\$1,639
94T-J29-S00 MAP	94T-J29-S02 MAP	Juvenile Table	25"H x 42" Diameter	110	\$1,848	\$1,639
94T-141-S00 MAP	94T-141-S02 MAP	Adult Table	29"H x 48" Diameter	120	\$1,848	\$1,639
94T-Y41-S00 MAP	94T-Y41-S02 MAP	Youth Table	27-1/2"H x 48" Diameter	120	\$1,848	\$1,639
94T-J41-S00 MAP	94T-J41-S02 MAP	Juvenile Table	25"H x 48" Diameter	120	\$1,848	\$1,639
N/A	94T-130-S02 MAP	Adult Table	29"H x 60" Diameter	140	N/A	\$2,184
N/A	94T-Y30-S02 MAP	Youth Table	27-1/2"H x 60" Diameter	140	N/A	\$2,184
N/A	94T-J30-S02 MAP	Juvenile Table	25"H x 60" Diameter	140	N/A	\$2,184
Square Oak Table						
94T-191-S00 OAK	94T-191-S02 OAK	Adult Table	29" x 30" x 30"	110	\$1,377	\$1,216
94T-Y91-S00 OAK	94T-Y91-S02 OAK	Youth Table	27-1/2" x 30" x 30"	110	\$1,377	\$1,216
94T-J91-S00 OAK	94T-J91-S02 OAK	Juvenile Table	25" x 30" x 30"	110	\$1,377	\$1,216
94T-137-S00 OAK	94T-137-S02 OAK	Adult Table	29" x 42" x 42"	110	\$1,510	\$1,307
94T-Y37-S00 OAK	94T-Y37-S02 OAK	Youth Table	27-1/2" x 42" x 42"	110	\$1,510	\$1,307
94T-J37-S00 OAK	94T-J37-S02 OAK	Juvenile Table	25" x 42" x 42"	110	\$1,510	\$1,307
94T-154-S00 OAK	94T-154-S02 OAK	Adult Table	29" x 48" x 48"	110	\$1,647	\$1,460
94T-Y54-S00 OAK	94T-Y54-S02 OAK	Youth Table	27-1/2" x 48" x 48"	110	\$1,647	\$1,460
94T-J54-S00 OAK	94T-J54-S02 OAK	Juvenile Table	25" x 48" x 48"	110	\$1,647	\$1,460
Square Maple Table						
94T-191-S00 MAP	94T-191-S02 MAP	Adult Table	29" x 30" x 30"	110	\$1,501	\$1,326
94T-Y91-S00 MAP	94T-Y91-S02 MAP	Youth Table	27-1/2" x 30" x 30"	110	\$1,501	\$1,326
94T-J91-S00 MAP	94T-J91-S02 MAP	Juvenile Table	25" x 30" x 30"	110	\$1,501	\$1,326
94T-137-S00 MAP	94T-137-S02 MAP	Adult Table	29" x 42" x 42"	110	\$1,646	\$1,425
94T-Y37-S00 MAP	94T-Y37-S02 MAP	Youth Table	27-1/2" x 42" x 42"	110	\$1,646	\$1,425
94T-J37-S00 MAP	94T-J37-S02 MAP	Juvenile Table	25" x 42" x 42"	110	\$1,646	\$1,425
94T-154-S00 MAP	94T-154-S02 MAP	Adult Table	29" x 48" x 48"	110	\$1,795	\$1,591
94T-Y54-S00 MAP	94T-Y54-S02 MAP	Youth Table	27-1/2" x 48" x 48"	110	\$1,795	\$1,591
94T-J54-S00 MAP	94T-J54-S02 MAP	Juvenile Table	25" x 48" x 48"	110	\$1,795	\$1,591

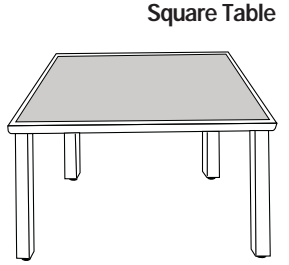
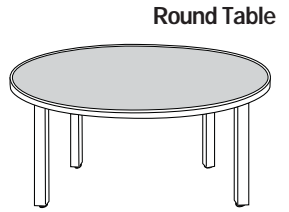

Catalog No.	Description	Price
LG-CST-S00	Wood Leg Caster 3" black nylon, hooded, twin-wheel caster with a brake. Add one caster per table leg (sold each).	\$84

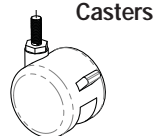

Please specify Wood Finish (Table 1) and High-Pressure Laminate (Table 2). Details can be found on page GEN 4.

Note: Optional Wood Aprons for Tables are located on page QUO 7.

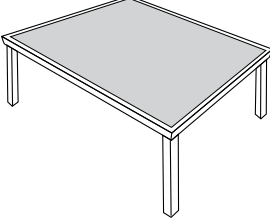
	Plywood Core Catalog No.	Particleboard Core Catalog No.	Description	H x W x D	Wt. (lbs.)	Plywood Core Price	Particleboard Core Price
Four-Reader Rectrangular Table 	<i>Four-Reader Rectangular Oak Table</i>						
	94T-194-S00 OAK	94T-194-S02 OAK	Adult Table	29" x 30" x 60"	120	\$1,409	\$1,205
	94T-Y94-S00 OAK	94T-Y94-S02 OAK	Youth Table	27-1/2" x 30" x 60"	120	\$1,409	\$1,205
	94T-J94-S00 OAK	94T-J94-S02 OAK	Juvenile Table	25" x 30" x 60"	120	\$1,409	\$1,205
	94T-195-S00 OAK	94T-195-S02 OAK	Adult Table	29" x 30" x 72"	140	\$1,565	\$1,342
	94T-Y95-S00 OAK	94T-Y95-S02 OAK	Youth Table	27-1/2" x 30" x 72"	140	\$1,565	\$1,342
	94T-J95-S00 OAK	94T-J95-S02 OAK	Juvenile Table	25" x 30" x 72"	140	\$1,565	\$1,342
	<i>Four-Reader Rectangular Maple Table</i>						
	94T-194-S00 MAP	94T-194-S02 MAP	Adult Table	29" x 30" x 60"	120	\$1,537	\$1,313
	94T-Y94-S00 MAP	94T-Y94-S02 MAP	Youth Table	27-1/2" x 30" x 60"	120	\$1,537	\$1,313
	94T-J94-S00 MAP	94T-J94-S02 MAP	Juvenile Table	25" x 30" x 60"	120	\$1,537	\$1,313
	94T-195-S00 MAP	94T-195-S02 MAP	Adult Table	29" x 30" x 72"	140	\$1,706	\$1,463
94T-Y95-S00 MAP	94T-Y95-S02 MAP	Youth Table	27-1/2" x 30" x 72"	140	\$1,706	\$1,463	
94T-J95-S00 MAP	94T-J95-S02 MAP	Juvenile Table	25" x 30" x 72"	140	\$1,706	\$1,463	

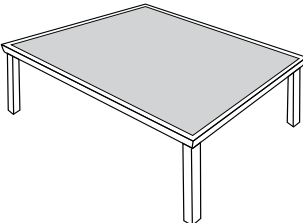
Six-Reader Rectrangular Table 	<i>Six-Reader Rectangular Oak Table</i>						
	94T-144-S00 OAK	94T-144-S02 OAK	Adult Table	29" x 36" x 60"	120	\$1,489	\$1,299
	94T-Y44-S00 OAK	94T-Y44-S02 OAK	Youth Table	27-1/2" x 36" x 60"	120	\$1,489	\$1,299
	94T-J44-S00 OAK	94T-J44-S02 OAK	Juvenile Table	25" x 36" x 60"	120	\$1,489	\$1,299
	94T-138-S00 OAK	94T-138-S02 OAK	Adult Table	29" x 36" x 72"	140	\$1,633	\$1,435
	94T-Y38-S00 OAK	94T-Y38-S02 OAK	Youth Table	27-1/2" x 36" x 72"	140	\$1,633	\$1,435
	94T-J38-S00 OAK	94T-J38-S02 OAK	Juvenile Table	25" x 36" x 72"	140	\$1,633	\$1,435
	94T-145-S00 OAK	94T-145-S02 OAK	Adult Table	29" x 48" x 72"	170	\$1,792	\$1,595
	94T-Y45-S00 OAK	94T-Y45-S02 OAK	Youth Table	27-1/2" x 48" x 72"	170	\$1,792	\$1,595
	94T-J45-S00 OAK	94T-J45-S02 OAK	Juvenile Table	25" x 48" x 72"	170	\$1,792	\$1,595
	<i>Six-Reader Rectangular Maple Table</i>						
	94T-144-S00 MAP	94T-144-S02 MAP	Adult Table	29" x 36" x 60"	120	\$1,623	\$1,417
94T-Y44-S00 MAP	94T-Y44-S02 MAP	Youth Table	27-1/2" x 36" x 60"	120	\$1,623	\$1,417	
94T-J44-S00 MAP	94T-J44-S02 MAP	Juvenile Table	25" x 36" x 60"	120	\$1,623	\$1,417	
94T-138-S00 MAP	94T-138-S02 MAP	Adult Table	29" x 36" x 72"	140	\$1,780	\$1,564	
94T-Y38-S00 MAP	94T-Y38-S02 MAP	Youth Table	27-1/2" x 36" x 72"	140	\$1,780	\$1,564	
94T-J38-S00 MAP	94T-J38-S02 MAP	Juvenile Table	25" x 36" x 72"	140	\$1,780	\$1,564	
94T-145-S00 MAP	94T-145-S02 MAP	Adult Table	29" x 48" x 72"	170	\$1,953	\$1,738	
94T-Y45-S00 MAP	94T-Y45-S02 MAP	Youth Table	27-1/2" x 48" x 72"	170	\$1,953	\$1,738	
94T-J45-S00 MAP	94T-J45-S02 MAP	Juvenile Table	25" x 48" x 72"	170	\$1,953	\$1,738	

	Catalog No.	Description	Price
Casters 	LG-CST-S00	Wood Leg Caster 3" black nylon, hooded, twin-wheel caster with a brake. Add one caster per table leg (sold each).	\$84

Please specify Wood Finish (Table 1) and High-Pressure Laminate (Table 2). Details can be found on page GEN 4.

Note: Optional Wood Aprons for Tables are located on page QUO 7.

Plywood Core Catalog No.	Particleboard Core Catalog No.	Description	H x W x D	Wt. (lbs.)	Plywood Core Price	Particleboard Core Price
<i>Rectangular Oak Table with Center Support Legs</i>						
94T-198-S00 OAK	94T-198-S02 OAK	Adult Table	29" x 30" x 90"	165	\$2,136	\$1,870
94T-Y98-S00 OAK	94T-Y98-S02 OAK	Youth Table	27-1/2" x 30" x 90"	165	\$2,136	\$1,870
94T-J98-S00 OAK	94T-J98-S02 OAK	Juvenile Table	25" x 30" x 90"	165	\$2,136	\$1,870
94T-146-S00 OAK	94T-146-S02 OAK	Adult Table	29" x 36" x 90"	165	\$2,217	\$1,928
94T-Y46-S00 OAK	94T-Y46-S02 OAK	Youth Table	27-1/2" x 36" x 90"	165	\$2,217	\$1,928
94T-J46-S00 OAK	94T-J46-S02 OAK	Juvenile Table	25" x 36" x 90"	165	\$2,217	\$1,928
94T-134-S00 OAK	94T-134-S02 OAK	Adult Table	29" x 48" x 90"	185	\$2,365	\$2,058
94T-Y34-S00 OAK	94T-Y34-S02 OAK	Youth Table	27-1/2" x 48" x 90"	185	\$2,365	\$2,058
94T-J34-S00 OAK	94T-J34-S02 OAK	Juvenile Table	25" x 48" x 90"	185	\$2,365	\$2,058

Rectangular Table with Center Support Legs

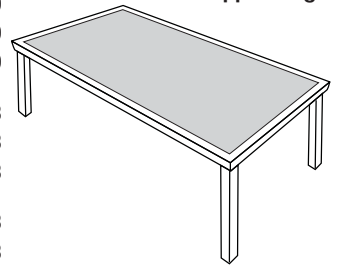

<i>Rectangular Maple Table with Center Support Legs</i>						
94T-198-S00 MAP	94T-198-S02 MAP	Adult Table	29" x 30" x 90"	165	\$2,329	\$2,038
94T-Y98-S00 MAP	94T-Y98-S02 MAP	Youth Table	27-1/2" x 30" x 90"	165	\$2,329	\$2,038
94T-J98-S00 MAP	94T-J98-S02 MAP	Juvenile Table	25" x 30" x 90"	165	\$2,329	\$2,038
94T-146-S00 MAP	94T-146-S02 MAP	Adult Table	29" x 36" x 90"	165	\$2,416	\$2,101
94T-Y46-S00 MAP	94T-Y46-S02 MAP	Youth Table	27-1/2" x 36" x 90"	165	\$2,416	\$2,101
94T-J46-S00 MAP	94T-J46-S02 MAP	Juvenile Table	25" x 36" x 90"	165	\$2,416	\$2,101
94T-134-S00 MAP	94T-134-S02 MAP	Adult Table	29" x 48" x 90"	185	\$2,579	\$2,243
94T-Y34-S00 MAP	94T-Y34-S02 MAP	Youth Table	27-1/2" x 48" x 90"	185	\$2,579	\$2,243
94T-J34-S00 MAP	94T-J34-S02 MAP	Juvenile Table	25" x 48" x 90"	185	\$2,579	\$2,243

Catalog No.	Description	Price
LG-CST-S00	Wood Leg Caster 3" black nylon, hooded, twin-wheel caster with a brake. Add one caster per table leg (sold each).	\$84

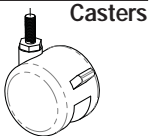

Please specify Wood Finish (Table 1) and High-Pressure Laminate (Table 2). Details can be found on page GEN 4.
 Note: Optional Wood Aprons for Tables are located on page QUO 7.

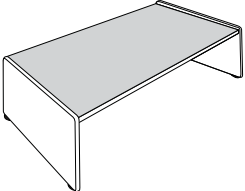
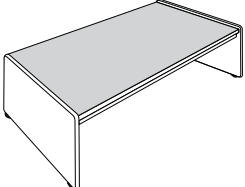
	Plywood Core Catalog No.	Particleboard Catalog No.	Description	H x W x D	Wt. (lbs.)	Plywood Core Price	Particleboard Price
Four-Reader with Panel Base 	<i>Four-Reader with Panel Base Oak Table</i>						
	94T-P44-S00 OAK	94T-P44-S02 OAK	Four Reader Table	29" x 60" x 36"	145	\$2,040	\$1,808
	94T-P38-S00 OAK	94T-P38-S02 OAK	Four Reader Table	29" x 72" x 36"	158	\$2,114	\$1,857
	94T-P45-S00 OAK	94T-P45-S02 OAK	Four Reader Table	29" x 72" x 48"	206	\$2,561	\$2,290
	<i>Four-Reader with Panel Base Maple Table</i>						
	94T-P44-S00 MAP	94T-P44-S02 MAP	Four Reader Table	29" x 60" x 36"	145	\$2,224	\$1,971
	94T-P38-S00 MAP	94T-P38-S02 MAP	Four Reader Table	29" x 72" x 36"	158	\$2,304	\$2,024
	94T-P45-S00 MAP	94T-P45-S02 MAP	Four Reader Table	29" x 72" x 48"	206	\$2,791	\$2,496
	Six-Reader with Panel Base 	<i>Six-Reader with Panel Base Oak Table</i>					
94T-P46-S00 OAK		94T-P46-S02 OAK	Six Reader Table	29" x 90" x 36"	178	\$2,492	\$2,226
94T-P34-S00 OAK		94T-P34-S02 OAK	Six Reader Table	29" x 90" x 48"	233	\$2,566	\$2,285
<i>Six-Reader with Panel Base Maple Table</i>							
94T-P46-S00 MAP		94T-P46-S02 MAP	Six Reader Table	29" x 90" x 36"	178	\$2,716	\$2,426
94T-P34-S00 MAP		94T-P34-S02 MAP	Six Reader Table	29" x 90" x 48"	233	\$2,797	\$2,491

Please specify Wood Finish (Table 1) and High-Pressure Laminate (Table 2). Details can be found on page GEN 4.

Optional Wood Aprons for Tables

An Apron is a 1-3/4"W x 25/32" Northern-grown red oak apron is fitted between the legs and behind the extended tabletop edge band. A 1/4" styling line, routed into the apron, highlights the tabletop and legs. The bottom edge and both ends of each apron receive a 1/2" radius.

Oak Catalog No.	Maple Catalog No.	Description	Wt. (lbs.)	Oak Price	Maple Price
109-AK-S00 OAK	109-AK-S00 MAP	For 36" Diameter Table	5	\$209	\$228
129-AK-S00 OAK	129-AK-S00 MAP	For 42" Diameter Table	5	\$209	\$228
141-AK-S00 OAK	141-AK-S00 MAP	For 48" Diameter Table	5	\$214	\$234
130-AK-S00 OAK	130-AK-S00 MAP	For 60" Diameter Table	5	\$227	\$247
191-AK-S00 OAK	191-AK-S00 MAP	For 30" Square Table	5	\$145	\$158
137-AK-S00 OAK	137-AK-S00 MAP	For 42" Square Table	5	\$154	\$168
154-AK-S00 OAK	154-AK-S00 MAP	For 48" Square Table	5	\$170	\$186
194-AK-S00 OAK	194-AK-S00 MAP	For 30" x 60" Table	5	\$174	\$190
195-AK-S00 OAK	195-AK-S00 MAP	For 30" x 72" Table	5	\$190	\$207
198-AK-S00 OAK	198-AK-S00 MAP	For 30" x 90" Table	5	\$193	\$210
144-AK-S00 OAK	144-AK-S00 MAP	For 36" x 60" Table	8	\$180	\$197
138-AK-S00 OAK	138-AK-S00 MAP	For 36" x 72" Table	8	\$198	\$215
146-AK-S00 OAK	146-AK-S00 MAP	For 36" x 90" Table	10	\$198	\$215
145-AK-S00 OAK	145-AK-S00 MAP	For 48" x 72" Table	10	\$209	\$228
134-AK-S00 OAK	134-AK-S00 MAP	For 48" x 90" Table	12	\$214	\$234

General Specifications

TABLETOP – 94T Series

Standard tabletops are 1-3/16" thick, 5-ply solid plywood or 1-3/16" thick particleboard core, including a top surface of .050" thick, high-pressure laminate with a backing sheet not less than .020" thick for balanced construction. High-pressure laminate has a lo-glare finish resistant to scratches, fading, and staining that meets or exceeds NEMA standards. Edges are solid Northern-grown red oak. Drop edge band is 5/8" thick x 1-5/8", externally banded to form a bullnose with a 1/4" radius at corners.

CHROME PEDESTAL BASE

Pedestal base consists of a 3" diameter column that is assembled to a 22-3/8" diameter floor base using a M16 x 55mm hex head bolt. The floor base comes equipped with five nylon glides. The floor base and column are attached to the 11-13/16" square table support using an M16 x 55mm hex head bolt. This base assembly is attached to the bottom of the tabletop by eight #12 x 1" phillips pan head screws.

BLACK POWDERED-COAT PEDESTAL BASE

Pedestal base consists of a 3" diameter column that is assembled to an "x" shaped 33" base diameter. Each leg is fitted with nylon base glides. The floor base and column are attached to the 11-13/16" square table support using an M16 x 55mm hex head bolt. This base assembly is attached to the bottom of the tabletop by eight #12 x 1" phillips pan head screws.

WOOD PEDESTAL BASE

Pedestal base will be solid Northern-grown Red Oak or maple. The base consists of four assembled leg components comprised of 6/4 solid material assembled using mortise and tenon construction. The upper horizontal part of the each base leg will receive borings for attaching the assembly to the tabletop. The lower horizontal piece will receive a 1-1/2" diameter, adjustable glide mounted in a recessed tee-nut which is further recessed into the leg by means of a counter-sink boring which accepts the upper two-thirds of the glide. All pedestal base edges will receive a 1/4" radius. The four assembled base components will connect to a 2-1/4" x 2-1/4" solid Northern-grown red oak or maple post using metal to metal hardware fasteners forming a one piece pedestal. Table tops are attached to base by bolting through the upper horizontal members of base into internal and external threaded bushings embedded in the under side of the table top.

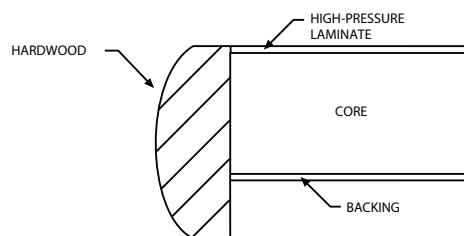

94T Series Drop Edge

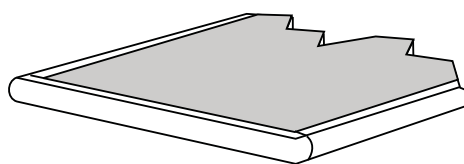

94T Series
External Edge Band

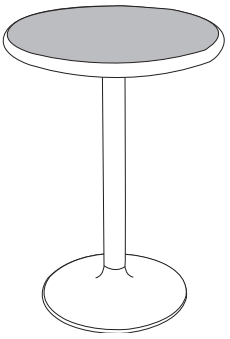
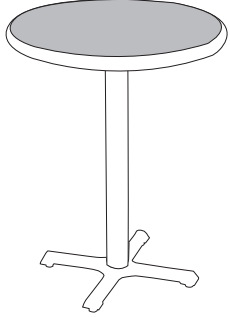
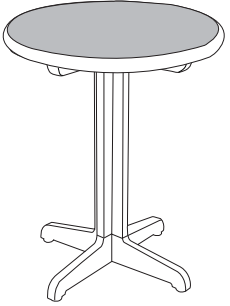
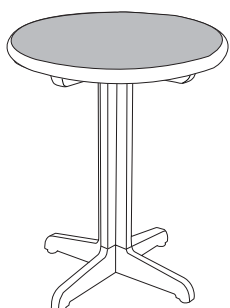
Plywood Core Catalog No.	Particleboard Core Catalog No.	Description	H x W x D	Wt. (lbs.)	Plywood Core Price	Particleboard Core Price	
94T4230RCS00	94T4230RCS02	Round Table	42" x 30" Diameter	75	\$2,563	\$2,307	Tables with Chrome Pedestal Base
94T4236RCS00	94T4236RCS02	Round Table	42" x 36" Diameter	95	\$2,609	\$2,450	
94T4230SCS00	94T4230SCS02	Square Table	42" x 30" x 30"	78	\$2,204	\$1,948	
94T4236SCS00	94T4236SCS02	Square Table	42" x 36" x 36"	98	\$2,209	\$2,050	
94T4230RBS00	94T4230RBS02	Round Table	42" x 30" Diameter	70	\$1,717	\$1,461	Tables with Black Powder-Coat Pedestal Base
94T4236RBS00	94T4236RBS02	Round Table	42" x 36" Diameter	92	\$1,763	\$1,604	
94T4230SBS00	94T4230SBS02	Square Table	42" x 30" x 30"	75	\$1,358	\$1,102	
94T4236SBS00	94T4236SBS02	Square Table	42" x 36" x 36"	100	\$1,363	\$1,205	
94T3936RWS00	94T3936RWS02	Round Table	39" x 36" Diameter	100	\$2,471	\$2,307	Tables with Oak Wood Pedestal Base
94T3942RWS00	94T3942RWS02	Round Table	39" x 42" Diameter	110	\$2,563	\$2,409	
94T3936SWS00	94T3936SWS02	Square Table	39" x 36" x 36"	115	\$1,994	\$1,835	
94T3942SWS00	94T3942SWS02	Square Table	39" x 42" x 42"	120	\$2,076	\$1,902	
94T3936RWS00 MAP	94T3936RWS02 MAP	Round Table	39" x 36" Diameter	100	\$2,693	\$2,514	Tables with Maple Wood Pedestal Base
94T3942RWS00 MAP	94T3942RWS02 MAP	Round Table	39" x 42" Diameter	110	\$2,793	\$2,626	
94T3936SWS00 MAP	94T3936SWS02 MAP	Square Table	39" x 36" x 36"	115	\$2,173	\$2,001	
94T3942SWS00 MAP	94T3942SWS02 MAP	Square Table	39" x 42" x 42"	120	\$2,263	\$2,073	

Please specify Wood Finish; if applicable (Table 1) and High-Pressure Laminate (Table 2). Details can be found on page GEN 4.

General Specifications

TABLETOPS – QUORUM 94T Series

Standard tabletop is 1-3/16" thick 3-ply particleboard core, including a top surface of .050" thick, high-pressure laminate with a backing sheet not less than .020" thick for balanced construction. High-pressure laminate has a lo-glare finish resistant to scratches, fading, and staining that meets or exceeds NEMA standards. Edges are solid Northern-grown red oak applied to the core after the top and bottom laminate sheets are applied. (External Edge Band). Drop edge band is 1-5/8"W and 5/8" thick and extends 3/8" below the core.

Note: Standing Height Tables are "Apron" construction.

LEGS WITHOUT APRON

Legs are glued up, 2-1/4" square Northern-grown red oak. All vertical edges of legs receive a 1/2" radius. Bottom edges of legs are radiused 1/8". Each leg has a 2" diameter, adjustable glide mounted in a recessed tee-nut. The glide is further recessed into the leg by means of a counter-sunk boring which accepts the upper two-thirds of the glide. Legs attach to tabletops by means of a 5" square x 5/16" thick cold-rolled steel plate. The plate is attached to the leg by a 5/16" x 2-1/2" machine bolt engaging a 5/8" diameter barrel nut inserted into the leg. The steel plate is attached to the tabletop by five 5/16" x 1" machine bolts engaging internally and externally threaded bushings in the underside of the tabletop. Leg plates are positioned behind and hidden by the extended table edge band.

LEGS WITH APRON

Legs are glued up, 2-1/4" Northern-grown red oak. All vertical edges of legs receive a 1/2" radius. Bottom edges of legs are radiused 1/8". Each leg has a 2" diameter, adjustable glide mounted in a recessed tee-nut. The glide is further recessed into the leg by means of counter-sunk boring which accepts the upper two-thirds of the glide. Legs attach to the aprons by means of formed 14-gauge steel corner brackets. Each leg is bolted to the corner bracket with two 5/16" -18 hex-head bolts per leg.

LEG (CENTER)

Additional leg(s) added to the center of the table for extra support are 2-1/4" square with a 1/2" radius on vertical edges.

APRON

A 3-1/2" W x 1" thick solid Northern-grown red oak apron is fitted between the legs and behind the extended tabletop edge band. A 1/4" styling line, routed into the apron, highlights the tabletop and legs. Bottom edge and both ends of each apron receive a 1/2" radius. Aprons are secured to the tabletop by attaching hardwood cleats to the inside surface of aprons and screwing through the cleats into the underside of the tabletop.

PRIVACY PANEL

Privacy panels are 10"H, constructed of 1" thick veneered particleboard. Exposed panel edges are banded with 1.6mm solid oak. The privacy panel attaches securely to the tabletop by screws passing through the tabletop and into the privacy panels and is finished to match the table. Privacy panel is designed to obscure wires exiting computer equipment and to eliminate incidental tampering.

COMPUTER SHELF

Shelf is manufactured from steel. The shelf is 8-3/4" below the work surface and is 23"W x 17"D and is mounted under tabletop.

ELECTRICAL

Tables receive 3" grommets in tabletop for wire passage, and J-channel wire managers mounted under tabletop to hold excess wires. Grommets are ABS, black plastic, with notched removable cap. J-channel is 18-gauge steel with electrostatically applied black powder paint.

TABLETOP HEIGHT

Standing Height: 39" (with Apron)

Sitting Height: 27-1/2" (without Apron)

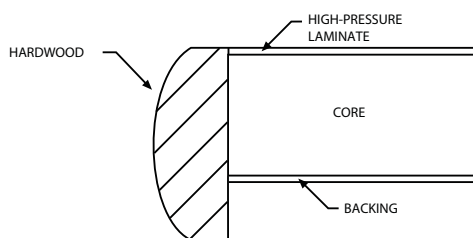

94T Series Drop Edge

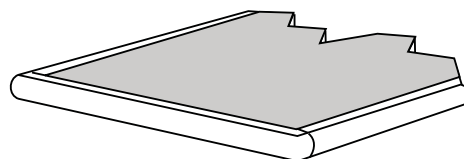

94T Series
External Edge Band

Oak Catalog No.	Maple Catalog No.	Description	H x W x D	Wt. (lbs.)	Oak Price	Maple Price	Standing with Apron	Sitting without Apron
94T-645-S00 OAK	94T-645-S00 MAP	Sitting Height	27-1/2" x 30" x 24"	80	\$1,204	\$1,312	One Position Computer Tables	
94T-665-S00 OAK	94T-665-S00 MAP	Sitting Height	27-1/2" x 30" x 30"	80	\$1,283	\$1,399		
94T-665-S05 OAK	94T-665-S05 MAP	Standing Height	39" x 30" x 30"	85	\$1,283	\$1,399		

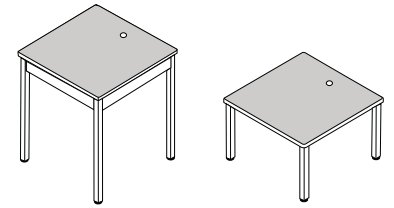

94T-649-S00 OAK	94T-649-S00 MAP	Sitting Height	27-1/2" x 60" x 24"	110	\$1,729	\$1,885	Two Position Computer Tables	
94T-669-S00 OAK	94T-669-S00 MAP	Sitting Height	27-1/2" x 60" x 30"	110	\$1,863	\$2,030		
94T-669-S05 OAK	94T-669-S05 MAP	Standing Height	39" x 60" x 30"	115	\$1,863	\$2,030		

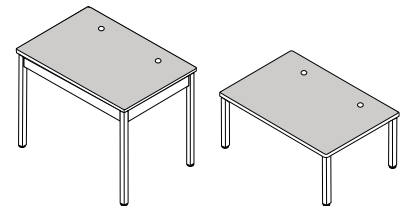

94T-643-S00 OAK	94T-643-S00 MAP	Sitting Height	27-1/2" x 36" x 24"	70	\$1,487	\$1,621	One Position Computer Table with 10"H Privacy Panel	
94T-663-S00 OAK	94T-663-S00 MAP	Sitting Height	27-1/2" x 36" x 36"	80	\$1,621	\$1,767		
94T-663-S05 OAK	94T-663-S05 MAP	Standing Height	39" x 36" x 36"	85	\$1,621	\$1,767		

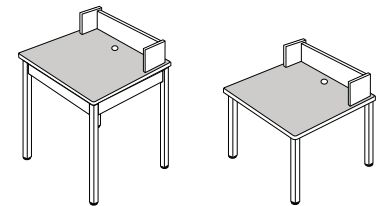

94T-642-S00 OAK	94T-642-S00 MAP	Sitting Height	27-1/2" x 72" x 24"	150	\$2,029	\$2,211	Two Position Computer Table with 10"H Privacy Panel	
94T-662-S00 OAK	94T-662-S00 MAP	Sitting Height	27-1/2" x 72" x 36"	150	\$2,162	\$2,357		
94T-662-S05 OAK	94T-662-S05 MAP	Standing Height	39" x 72" x 36"	150	\$2,162	\$2,357		

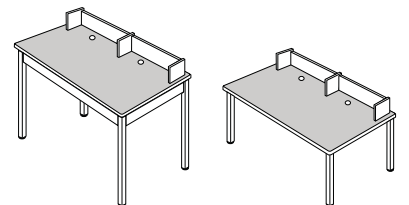

94T-644-S00 OAK	94T-644-S00 MAP	Sitting Height	27-1/2" x 90" x 24"	180	\$2,764	\$3,012	Three Position Computer Table with 10"H Privacy Panel	
94T-664-S00 OAK	94T-664-S00 MAP	Sitting Height	27-1/2" x 90" x 36"	170	\$2,898	\$3,159		
94T-664-S05 OAK	94T-664-S05 MAP	Standing Height	39" x 90" x 36"	180	\$2,898	\$3,159		

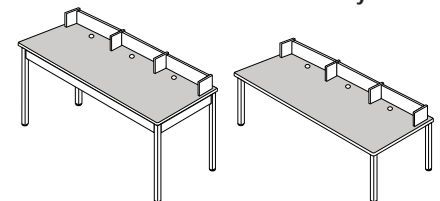

Please specify Wood Finish (Table 1) and High-Pressure Laminate (Table 2). Details can be found on page GEN 4.

Quorum 94T Collection

Computer Tables

Standing with Apron	Sitting without Apron	Oak Catalog No.	Maple Catalog No.	Description	H x W x D	Wt. (lbs.)	Oak Price	Maple Price
One Position Computer Table with 10"H Privacy Panel and Shelf		94T-663-S02 OAK	94T-663-S02 MAP	Sitting Height	27-1/2" x 36" x 36"	90	\$1,802	\$1,964
		94T-663-S06 OAK	94T-663-S06 MAP	Standing Height	39" x 36" x 36"	95	\$1,802	\$1,964

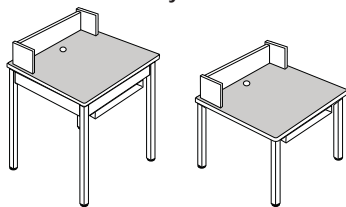

Two Position Computer Table with 10"H Privacy Panel and Shelf		94T-662-S02 OAK	94T-662-S02 MAP	Sitting Height	27-1/2" x 72" x 36"	160	\$2,444	\$2,664
		94T-662-S06 OAK	94T-662-S06 MAP	Standing Height	39" x 72" x 36"	160	\$2,444	\$2,664

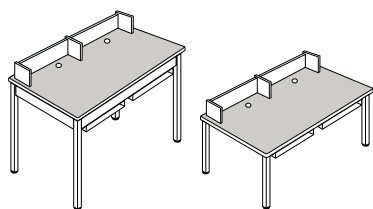

Three Position Computer Table with 10"H Privacy Panel and Shelf		94T-664-S02 OAK	94T-664-S02 MAP	Sitting Height	27-1/2" x 90" x 36"	190	\$3,305	\$3,602
		94T-664-S06 OAK	94T-664-S06 MAP	Standing Height	39" x 90" x 36"	200	\$3,305	\$3,602

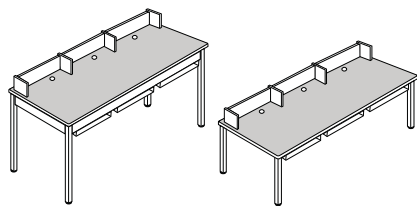

Please specify Wood Finish (Table 1) and High-Pressure Laminate (Table 2). Details can be found on page GEN 4.

General Specifications

WORK SURFACE

Work surfaces are 27-1/2"D, available in two widths: 48" and 36", and adjustable in heights to 27", 32" and 39".

Work surfaces are 1-3/16" thick, 3-ply particleboard core, including a top surface of .050" thick, high-pressure laminate with a backing sheet no less than .020" thick for balanced construction. High-pressure laminate has a lo-glare finish resistant to scratches, fading, and staining that meets or exceeds NEMA standards. Front edges of work surfaces have 1-5/8" x 5/8" solid-oak drop edge band which extends 3/8" below the work surface. The back edge of the top has a black plastic band 1-1/2"W which projects above the work surface 1/4" to act as a retainer. A 1-1/2"W cord drop is located at the back of the work surface.

PANELS

End and intermediate panels are 3/4" thick x 32-1/2"H x 30"W, comprised of select face veneers of Northern-grown red oak over a 45# particleboard core. Panels are banded on the top and bottom with 1.6mm thick solid oak. Panels are mechanically fastened to the back panel. Back panels are 32-1/2"H. Back panel construction is the same as end and intermediate panels.

POSTS

Posts are 1-3/4" square, with 1/8" grooved to receive panels in one-, two-, three- and four-way configurations. Each post has a 1-1/4" diameter, adjustable glide.

SHELF

A 12"D storage shelf, located under the work surface and extends the full width of the station.

ELECTRICAL

To hide excess wires, a 1-1/2" separation between the work surface and back panel is provided.

WORK SURFACE HEIGHTS

Adjustable at 27", 32" and 39".

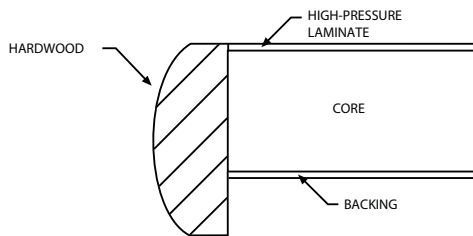

94T Series Drop Edge

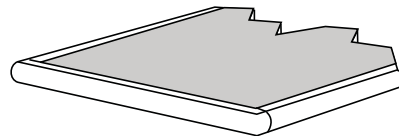

94T Series External Edge Band

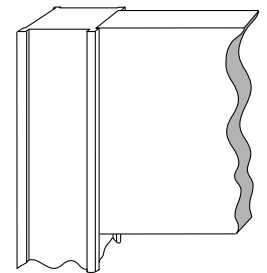

94T Series Panel & Post

	Oak Catalog No.	Maple Catalog No.	Description	H x W x D	Wt. (lbs.)	Oak Price	Maple Price
Single-Faced Information Access Workstations/Carrels	<u>36" Wide Working Space</u>						
	94T-673-S00 OAK	94T-673-S00 MAP	S/F Starter	47-3/4" x 38-1/8" x 33-1/2"	90	\$2,039	\$2,223
	94T-672-S00 OAK	94T-672-S00 MAP	S/F Adder	47-3/4" x 37" x 33-1/2"	80	\$1,755	\$1,913

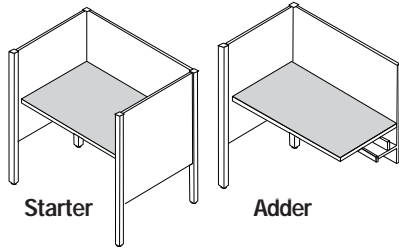

48" Wide Working Space

94T-460-S00 OAK	94T-460-S00 MAP	S/F Starter	47-3/4" x 50" x 33-1/2"	90	\$2,191	\$2,388
94T-459-S00 OAK	94T-459-S00 MAP	S/F Adder	47-3/4" x 48-1/2" x 33-1/2"	80	\$1,891	\$2,062

Double-Faced Information Access Workstations/Carrels	<u>36" Wide Working Space</u>						
	94T-674-S00 OAK	94T-674-S00 MAP	D/F Starter	47-3/4" x 38-1/8" x 65-1/4"	140	\$3,758	\$4,096
	94T-675-S00 OAK	94T-675-S00 MAP	D/F Adder	47-3/4" x 37" x 65-1/4"	126	\$3,124	\$3,405

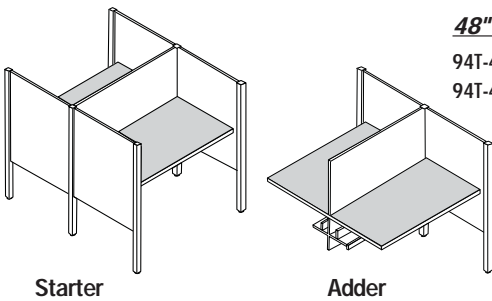

48" Wide Working Space

94T-461-S00 OAK	94T-461-S00 MAP	D/F Starter	47-3/4" x 50" x 65-1/4"	150	\$4,086	\$4,454
94T-462-S00 OAK	94T-462-S00 MAP	D/F Adder	47-3/4" x 48-1/2" x 65-1/4"	136	\$3,388	\$3,693

Pinwheel Design Information Access Workstations/Carrels	<u>36" Wide Working Space</u>						
	94T-676-S00 OAK	94T-676S00 MAP	Pinwheel	47-3/4" x 75-1/4" x 75-1/4"	375	\$6,279	\$6,844

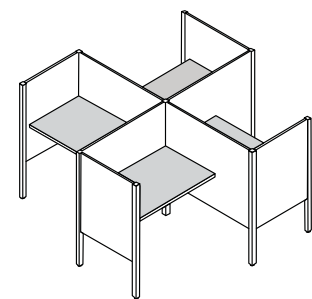

48" Wide Working Space

94T-463-S00 OAK	94T-463-S00 MAP	Pinwheel	47-3/4" x 98-1/2" x 98-1/2"	425	\$7,050	\$7,684
-----------------	-----------------	----------	-----------------------------	-----	---------	---------

Please specify Wood Finish (Table 1) and High-Pressure Laminate (Table 2). Details can be found on page GEN 4.

General Specifications

WORKSTATIONS

Workstations are of modular starter and adder design, with an overall height 33". Workstations are available in 36", 48", 72", 96", and 108" widths. A knee-space panel located below the work surface supports all work surfaces greater than 48" W. Work surface height is at 27-1/2". Work surface depth is 27-1/2" with an additional 1-1/2"W cord drop between the work surface and back panel to allow passage of electrical cords. Work surface is attached to end and intermediate panels by means of two metal 22-1/2" long "Z" brackets with 5/16" – 18 hex-head bolts engaging internally and externally threaded bushings embedded into panels. The back panel is attached to end and intermediate panels using hidden metal keyways and shoulder screws. The shelf is attached to end and intermediate panels and back panels with 3/4" x 3/4" steel, black painted angle brackets and black #8 screws.

WORK SURFACE

Standard work surface is 1-3/16" thick, 3-ply, 45# density particleboard including a top surface of .050" thick, high-pressure laminate with a backing sheet not less than .020" thick for balanced construction. High-pressure laminate has a lo-glare finish resistant to scratches, fading, and staining that meets or exceeds NEMA standards. Front edges of work surfaces have a 5/8" x 1-3/16" solid oak edge band in a half-round bullnose shape. The back edge of the top has a black plastic band 1-1/2"W which projects above the work surface 1/4" to act as a retainer.

END AND INTERMEDIATE PANELS

End and intermediate panels are 1-1/8" thick, 45# density particleboard core with select face veneers of Northern-grown red oak. All edges are banded with a 5/8" bullnosed solid-oak edge band. Intermediate panels receive a 3" diameter grommet below the work surface to allow passage of electrical and data wires. Each panel receives two 1-1/4" adjustable glides.

BACK PANEL

Back panel is 3/4" thick, 45# density particleboard core with face veneers of select Northern-grown red oak. The top and bottom edges of the back panel receives 5/8" bullnosed solid oak edge bands. Back panels attach to end and intermediate panels by means of recessed metal fasteners and shoulder screws. The back panel on double-faced units receive a 3" diameter grommet located below the work surface to allow passage of electrical and data wires.

SHELF

Shelf is 3/4" thick x 8"D 45# density particleboard core with face veneers of select Northern-grown red oak. Shelf is banded on the front edge with a 1.6mm solid oak band. Shelf attaches to end and intermediate panels by means of a pair of metal "L" brackets. Back corners of shelf have a 3" x 3" cutout to allow for the passage of electrical cords. The shelf is positioned 10" below the bottom of the work surface.

WIRE MANAGEMENT DOOR

The wire management door is positioned between the bottom of the work surface and the shelf and is designed to form a concealed wire management channel 8-1/2"H x 9-1/2"D. The door is 1/4" thick with select oak face veneers. The door slides in two aluminum tracks, one that is attached to the bottom of the work surface while the other is attached to the top of the shelf.

KNEE-SPACE PANEL

All 72" and 96"W workstations, as well as functional corner units, have a knee-space panel positioned under the work surface for additional work-surface support. Units 108" W have two knee-space panels. The knee-space panel is 1-1/8" thick, 45# density particleboard core with select face veneers of Northern-grown red oak. The panel is banded on exposed edges with a 1.6mm solid oak band. The knee-space panel is attached to the back panel using a 1-3/4" square, solid-oak post, grooved to receive the knee space panel and back panels. Panels attach to the post using recessed metal fasteners and shoulder screws. The knee-space panel is angled in the back to create a space to allow passage of electrical and data cords. The knee-space panel receives two 1-1/4" diameter black adjustable glides.

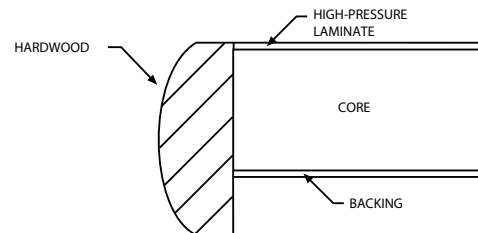

94T Series Drop Edge

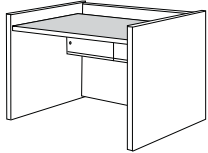
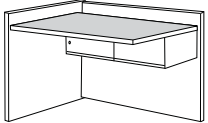
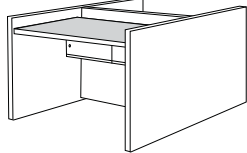
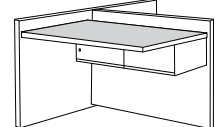
	Oak Catalog No.	Maple Catalog No.	Description	H x W x D	Wt. (lbs.)	Oak Price	Maple Price
Single-Faced One-Position Starter 	<u>36" Wide Working Space</u>						
	94T-S31-SS0 OAK	94T-S31-SS0 MAP	One-Position S/F Starter	33-1/2" x 37-1/2" x 31"	130	\$1,663	\$1,812
	94T-S31-SAO OAK	94T-S31-SAO MAP	One-Position S/F Adder	33-1/2" x 36-1/2" x 31"	100	\$1,424	\$1,552
Adder 	<u>48" Wide Working Space</u>						
	94T-S41-SS0 OAK	94T-S41-SS0 MAP	One-Position S/F Starter	33-1/2" x 49-1/4" x 31"	155	\$1,795	\$1,957
	94T-S41-SAO OAK	94T-S41-SAO MAP	One-Position S/F Adder	33-1/2" x 48" x 31"	125	\$1,521	\$1,658
Double-Faced One-Position Starter 	<u>36" Wide Working Space</u>						
	94T-D31-SS0 OAK	94T-D31-SS0 MAP	One-Position D/F Starter	33-1/2" x 37-1/2" x 59-1/2"	215	\$2,985	\$3,254
	94T-D31-SAO OAK	94T-D31-SAO MAP	One-Position D/F Adder	33-1/2" x 36-1/2" x 59-1/2"	155	\$2,531	\$2,759
Adder 	<u>48" Wide Working Space</u>						
	94T-D41-SS0 OAK	94T-D41-SS0 MAP	One-Position D/F Starter	33-1/2" x 49-1/4" x 59-1/2"	255	\$3,212	\$3,501
	94T-D41-SAO OAK	94T-D41-SAO MAP	One-Position D/F Adder	33-1/2" x 48" x 59-1/2"	195	\$2,734	\$2,980

Please specify Wood Finish (Table 1) and High-Pressure Laminate (Table 2).
 Details can be found on page GEN 4.

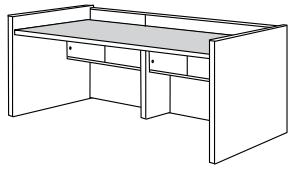
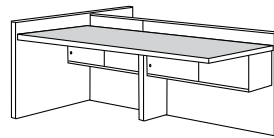
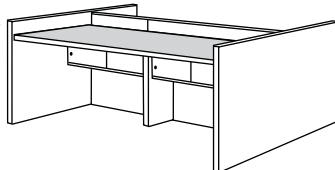
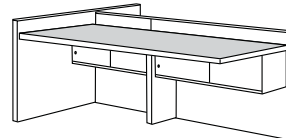
Oak Catalog No.	Maple Catalog No.	Description	H x W x D	Wt. (lbs.)	Oak Price	Maple Price	
<i>36" Wide Working Space</i>							 <p>Single-Faced Two-Position Starter</p>
94T-S32-SS0 OAK	94T-S32-SS0 MAP	Two-Position S/F Starter	33-1/2" x 74" x 31"	195	\$2,377	\$2,591	
94T-S32-SAO OAK	94T-S32-SAO MAP	Two-Position S/F Adder	33-1/2" x 73" x 31"	165	\$2,107	\$2,296	
<i>48" Wide Working Space</i>							 <p>Adder</p>
94T-S42-SS0 OAK	94T-S42-SS0 MAP	Two-Position S/F Starter	33-1/2" x 97-1/4" x 31"	235	\$2,626	\$2,863	
94T-S42-SAO OAK	94T-S42-SAO MAP	Two-Position S/F Adder	33-1/2" x 96" x 31"	205	\$2,305	\$2,512	
<i>36" Wide Working Space</i>							 <p>Double-Faced Two-Position Starter</p>
94T-D32-SS0 OAK	94T-D32-SS0 MAP	Two-Position D/F Starter	33-1/2" x 74" x 59-1/2"	330	\$4,231	\$4,611	
94T-D32-SAO OAK	94T-D32-SAO MAP	Two-Position D/F Adder	33-1/2" x 73" x 59-1/2"	270	\$3,802	\$4,144	
<i>48" Wide Working Space</i>							 <p>Adder</p>
94T-D42-SS0 OAK	94T-D42-SS0 MAP	Two-Position D/F Starter	33-1/2" x 97-1/4" x 59-1/2"	410	\$4,598	\$5,012	
94T-D42-SAO OAK	94T-D42-SAO MAP	Two-Position D/F Adder	33-1/2" x 96" x 59-1/2"	155	\$4,160	\$4,534	

Please specify Wood Finish (Table 1) and High-Pressure Laminate (Table 2).
 Details can be found on page GEN 4.

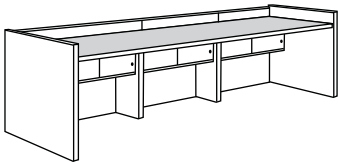
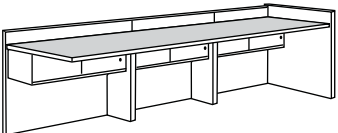
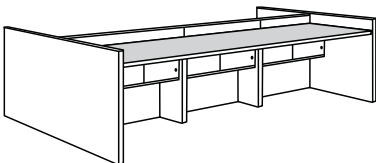
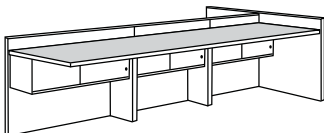
	Oak Catalog No.	Maple Catalog No.	Description	H x W x D	Wt. (lbs.)	Oak Price	Maple Price
Single-Faced Three-Position Starter 							
	<i>36" Wide Working Space</i>						
	94T-S33-SS0 OAK	94T-S33-SS0 MAP	Three-Position S/F Starter	33-1/2" x 110-1/2" x 31"	260	\$3,223	\$3,513
Adder 	94T-S33-SAO OAK	94T-S33-SAO MAP	Three-Position S/F Adder	33-1/2" x 109-1/4" x 31"	230	\$2,804	\$3,056
<hr/>							
Double-Faced Three-Position Starter 							
	<i>36" Wide Working Space</i>						
	94T-D33-SS0 OAK	94T-D33-SS0 MAP	Three-Position D/F Starter	33-1/2" x 110-1/2" x 59-1/2"	445	\$5,773	\$6,292
Adder 	94T-D33-SAO OAK	94T-D33-SAO MAP	Three Position D/F Adder	33-1/2" x 109-1/4" x 59-1/2"	385	\$5,292	\$5,768

Please specify Wood Finish (Table 1) and High-Pressure Laminate (Table 2).
 Details can be found on page GEN 4.

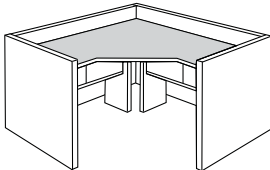
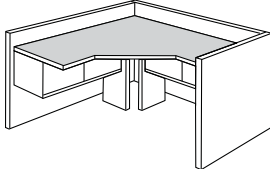
Oak Catalog No.	Maple Catalog No.	Description	H x W x D	Wt. (lbs.)	Oak Price	Maple Price	
94T-SCR-SSO OAK	94T-SCR-SSO MAP	90-Degree Functional Corner Starter	33-1/2" x 62" x 31"	225	\$3,937	\$4,291	<p>90° Functional Corner Unit Starter</p> 
94T-SCR-SAO OAK	94T-SCR-SAO MAP	90-Degree Functional Corner Adder	33-1/2" x 62" x 31"	195	\$3,781	\$4,121	<p>Adder</p> 

Please specify Wood Finish (Table 1) and High-Pressure Laminate (Table 2).
 Details can be found on page GEN 4.

General Specifications

TOP

Top is 1-3/16" thick, 3-ply particleboard core including a top surface of .050" thick, high-pressure laminate with a backing sheet not less than .020" thick for balanced construction. The high-pressure laminate has a lo-glare finish resistant to scratches, fading, and staining in accordance with NEMA standards. Front edges of work surfaces have a 5/8" thick solid-oak flush edge band.

VERTICAL PANELS

Full panels are 1-3/16" thick and comprised of select face veneers of Northern-grown red oak over a particleboard core. Panels are externally banded on all four sides with a 5/8" thick solid-oak edge band in straight design. Panels receive 1/2" radius on all corners. The bottom of each panel has two flush-mounted tee-nuts to receive a 1-1/4" diameter, rubber-cushioned chrome glide. Panels are equipped with grommets to allow wire passage from station to station.

BACK PANELS

Back panels are 1-3/16" thick and comprised of select face veneers of Northern-grown red oak over particleboard core. The panel is externally banded on the top and bottom edge with a 1.6mm band. The panel attaches to the corner posts by means of mechanical fasteners.

ELECTRICAL ACCESS DOOR

(One for each 3- or 6- station unit) Access door is 3/4" thick and comprised of select face veneers of Northern-grown red oak over a particleboard core. Panel is externally banded on all four sides with a 1.6mm solid-oak edge band. Access door has a full length hinge and lock and can be located in any one of the back panels on the station.

CENTER CAP

Cap is constructed of 3/4" plastic and backer. Available in full-hexagon or half-hexagon configuration, the cap closes the center opening by mounting at the top rear edge of end panels on systems arranged in full- or half-hexagon configuration.

AVAILABLE WORKING SPACE

Depth of monitor and keyboard combined cannot exceed 29".

WORKING SPACE HEIGHTS

Working space is adjustable to:

Standing Height: 39"

ADA Height: 32"

Sitting Height: 27"

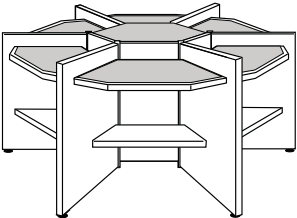
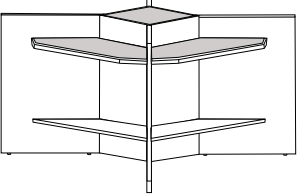
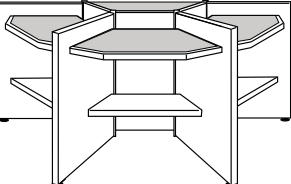
	Oak Catalog No.	Maple Catalog No.	Description	H x W x D	Wt. (lbs.)	Oak Price	Maple Price
 <p>Six Position PAC Station</p>	94T-682-S00 OAK	94T-682-S00 MAP	Six position with angular tops.	42-1/4" x 99-1/4" x 99-1/4"	629	\$11,196	\$12,204
 <p>Four Position PAC Station</p>	94T-688-S00 OAK	94T-688-S00 MAP	Four position with angular tops.	42-1/4" x 75-1/2" x 75-1/2"	510	\$8,598	\$9,372
 <p>Three Position PAC Station</p>	94T-685-S00 OAK	94T-685-S00 MAP	Three position with angular tops. Composed of one starter unit and two adder units.	42-1/4" x 99-1/2" x 47-1/2"	401	\$6,015	\$6,557

Please specify Wood Finish (Table 1) and High-Pressure Laminate (Table 2).
Details can be found on page GEN 4.

General Specifications

DESKTOPS

Standard desktop is 1-3/16" thick, 3-ply, 45# density particleboard core, with a high-pressure laminate top surface .050" thick and a backing sheet .020" thick for balanced construction. High-pressure laminate has a lo-glare finish resistant to scratches, fading and staining that meets or exceeds NEMA standards. The desk top receives a solid Northern-grown Red Oak or maple edge band 5/8" thick x 1-3/16" formed in a bullnose shape. All edges are applied to the desktop after the laminate and backer sheets are applied, constituting an external edge band.

END PANEL

End panels are 1-3/16" thick, 3-ply, 45# density particleboard core with select plain-sliced slip matched Northern-grown Red Oak or maple veneer on both sides. Exposed vertical edges are externally banded with a 5/8" thick x 1-3/16" solid, Northern-grown Red Oak or maple edge band formed in a bullnose shape. Top and bottom of the end panels are banded with a 1/8" x 1-3/16" edge band with the edges eased.

FRONT PANEL

The front panels are 1-3/16" thick, 3-ply, 45# density particleboard core with select plain-sliced slip matched Northern-grown Red Oak or maple veneer on both sides. Exposed vertical edges are externally banded with a 5/8" thick x 1-3/16" solid, Northern-grown Red Oak or maple edge band formed in a bullnose shape. Top and bottom of the end panels are banded with a 1/8" x 1-3/16" edge band with the edges eased.

SHELVES

Shelves are constructed of 7-ply, furniture-grade veneer-core hardwood plywood, with Northern-grown Red Oak plain sliced face veneer or maple plain sliced face veneer. Exposed edges receive a 1.6mm thick, solid-oak or maple edge band.

DRAWER

Drawer is constructed of solid Northern-grown Red Oak or maple with 1/4" thick wood bottom panel. Drawer has 3-ply particleboard fronts with select oak-face veneer or maple veneer. Box drawer has extension slides with 100# load capacity. File drawer is letter size and has full-extension slides with 100# load capacity. File drawers also have hangers to conveniently support hanging files.

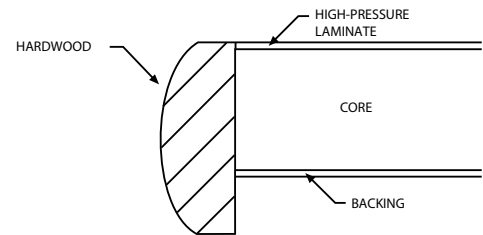

94T Series Drop Edge

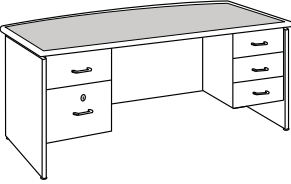
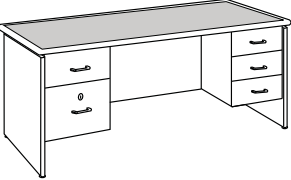
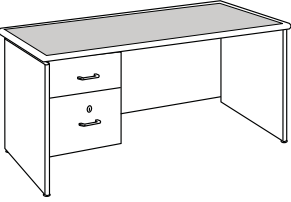
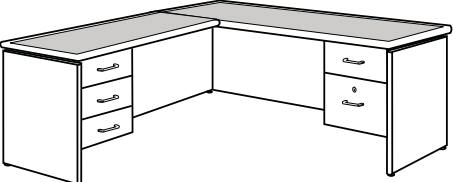
	Oak Catalog No.	Maple Catalog No.	Description	H x W x D	Wt. (lbs.)	Oak Price	Maple Price
Bow Front Double Pedestal Desk 	94T-501-S00 OAK	94T-501-S00 MAP	Bow Front Double Pedestal Desk Desk has a curved front work surface. The left pedestal has a storage drawer and a file drawer with lock. The right pedestal has three storage drawers.	29" x 72" x 37"	261	\$5,954	\$6,490
Straight Front Double Pedestal Desk 	94T-502-S00 OAK	94T-502-S00 MAP	Straight Front Double Pedestal Desk Desk has a straight front work surface. The left pedestal has a storage drawer and a file drawer with lock. The right pedestal has three storage drawers.	29" x 72" x 30"	252	\$5,777	\$6,296
Straight Front Single Pedestal Desk 	94T-503-S00 OAK	94T-503-S00 MAP	Straight Front Single Pedestal Desk Desk has a straight front work surface. One pedestal with a storage drawer and a file drawer with lock.	29" x 48" x 30"	210	\$4,339	\$4,730
L-Shaped Left Return Desk 	94T-504-S00 OAK	94T-504-S00 MAP	L-Shaped Left Return L-Shaped Left Desk Desk has a straight front work surface. Desk pedestal has a storage drawer and a file drawer with lock. The return has three storage drawers.	29" x 47" x 25-3/4" 29" x 72" x 30"	390	\$6,714	\$7,317

Please specify Wood Finish (Table 1) and High-Pressure Laminate (Table 2). Details can be found on page GEN 4.

Oak Catalog No.	Maple Catalog No.	Description	H x W x D	Wt. (lbs.)	Oak Price	Maple Price	
94T-505-S00 OAK	94T-505-S00 MAP	L-Shaped Right Return L-Shaped Right Desk	29" x 47" x 25-3/4" 29" x 72" x 30"	390	\$6,714	\$7,317	L-Shaped Right Return Desk

Desk has a straight front work surface.
Desk pedestal has a storage drawer and a file drawer with lock. The return has three storage drawers.

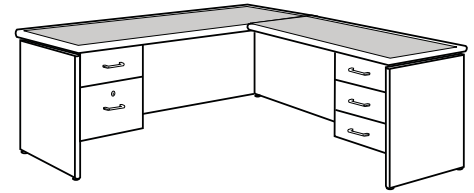

94T-506-S00 OAK	94T-506-S00 MAP	Storage Credenza	29" x 71-5/8" x 25-1/4"	285	\$6,522	\$7,109	Storage Credenza
-----------------	-----------------	------------------	-------------------------	-----	---------	---------	------------------

The credenza contains one pedestal on each end. Each pedestal contains one storage drawer and one letter-size file drawer. There is a two-door storage area with one adjustable shelf in the center of the credenza. The left pedestal has a lock which is concealed inside the storage

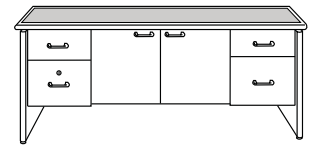

94T-507-S00 OAK	94T-507-S00 MAP	Kneespace Credenza	29" x 71-5/8" x 25-1/4"	245	\$5,627	\$6,133	Kneespace Credenza
-----------------	-----------------	--------------------	-------------------------	-----	---------	---------	--------------------

The credenza contains a two drawer pedestal on each end. Each pedestal contains one storage drawer and one letter-size file drawer. The left pedestal has a lock. The middle area of the credenza is open for have knee space while working at a computer.

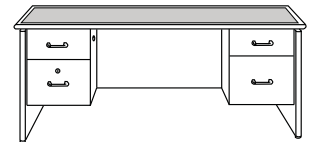

Please specify Wood Finish (Table 1) and High-Pressure Laminate (Table 2). Details can be found on page GEN 4.

	Oak Catalog No.	Maple Catalog No.	Description	H x W x D	Wt. (lbs.)	Oak Price	Maple Price
Dictionary Stand	94T-869-S00 OAK	94T-869-S00 MAP	Adult Height	45-1/2" x 25-7/8" x 16-1/2"	80	\$1,716	\$1,871
	94T-469-S00 OAK	94T-469-S00 MAP	Children's Height	38-1/2" x 25-7/8" x 16-1/2"	67	\$1,716	\$1,871

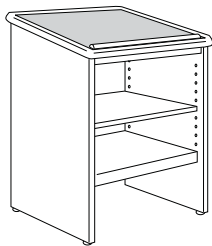

Sloped top is 1-3/16" thick, 3-ply particleboard including a top surface of .050" thick high-pressure laminate with a backing sheet not less than .020" thick. Edge band of sloped top is 1-3/16" x 5/8" solid oak, applied to all exposed edges forming a half-round bullnose shape. Edge band is applied after the top and bottom laminate sheets are applied (External Edge Band). A 5/8" x 5/8" book retainer is positioned along the bottom edge of sloped top. The full height 1/2" plywood back is recessed into the end panels. Inside faces of end panels allow for shelf adjustment on 1/2" center. Bottom shelf is stationary. End panels are 1-3/16", 7-ply veneer-core plywood construction with select oak-veneer facings. Vertical edges receive 1/2" solid oak banding, radiused 1/4".

	Oak Catalog No.	Maple Catalog No.	Description	H x W x D	Wt. (lbs.)	Oak Price	Maple Price
Atlas Stand	94T-871-S00 OAK	94T-871-S00 MAP	Adult Height	45-9/16" x 29-7/8" x 29"	200	\$3,275	\$3,571
	94T-471-S00 OAK	94T-471-S00 MAP	Children's Height	38-9/16" x 29-7/8" x 29"	180	\$3,275	\$3,571

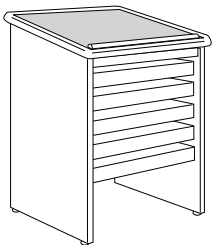

Sloped top is 1-3/16" thick, 3-ply particleboard including top surface of .050" thick high-pressure laminate with a backing sheet not less than .020" thick. Edge band of sloped top is 1-3/16" x 5/8" solid oak, applied to all exposed edges forming a half-round bullnose shape. Edge band is applied after the top and bottom laminate sheets are applied (External Edge Band). A 5/8" x 5/8" book retainer is positioned along the bottom edge of sloped top. End panels and back panel are 1-3/16", 7-ply veneer-core plywood construction, with select oak-veneer facings. Vertical edges receive 1/2" solid-oak banding, radiused on 1/4". Sides and back are tenoned together. Each unit has five pullout shelves on nylon rollers. Stops on shelves prevent accidental removal. Shelves are 25-3/4"W x 23-7/8"D, with 3" between shelves. Children's height unit contains four pullout shelves with 2-1/2" between shelves.

Please specify Wood Finish (Table 1) and High-Pressure Laminate (Table 2). Details can be found on page GEN 4.

**Horizontal Newspaper Rack and
End-of-Range Computer Station**

Quorum 94T Collection

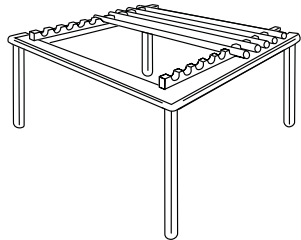
Oak Catalog No.	Maple Catalog No.	Description	H x W x D	Wt. (lbs.)	Oak Price	Maple Price	
94T-179-S00 OAK	94T-179-S00 MAP	Horizontal Newspaper Rack This rack has a top frame, open to receive newspapers. The rack has two holders, one on each side. Each holder has ten U-shaped grooves 1-1/4" W with a radius at the bottom to receive ten newspaper sticks which are included.	31" x 37-1/4" x 24-5/8"	55	\$1,747	\$1,904	Horizontal Newspaper Rack 

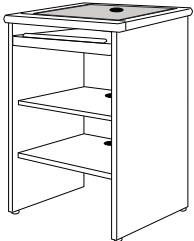
94T-039-S00 OAK	94T-039-S00 MAP	End-of-Range Computer Station Designed to fit at end of double-faced shelving range. Standard tabletop is 1-3/16" thick with high-pressure laminate on the top surface, with one 3" diameter grommet, and with 5/8" thick external solid wood edge bands with the 94T-series shape. End panels are 1-3/16" thick wood veneered and edge banded. Unit has two full-depth fixed shelves with 3" diameter grommets and one pullout shelf for the keyboard. Space above the fixed shelves is 11". Adjustable glides are provided for leveling the unit.	39-1/4" x 24-1/8" x 20"	55	\$1,656	\$1,805	End-of-Range Computer Station 
-----------------	-----------------	--	-------------------------	----	---------	---------	--

Please specify Wood Finish (Table 1) and High-Pressure Laminate (Table 2). Details can be found on page GEN 4.

	Oak Catalog No.	Maple Catalog No.	Description	H x W x D	Wt. (lbs.)	Oak Price	Maple Price
Picture Book Table	94T-142-S00 OAK	94T-142-S00 MAP	Picture Book Table	33-1/2" x 78" x 32"	190	\$3,509	\$3,825

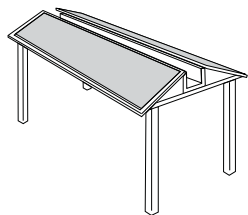

The table consists of two 78"W x 15-1/2" D x 1-3/16" thick tops mounted on a 27° angle. The lower edge of the tops are 26-1/2" from the floor. A 5/8" square retaining strip is screwed onto each top near the lower edge. A space of 3" is allowed between the tops to serve as a full-width book well.

Table base construction, including legs, accent strip, tabletop support and tabletop edge treatment, is the same as the series you are ordering. (See reading table specifications for series required.)

Bench	94T-147-S00 OAK	94T-147-S00 MAP	Bench	15-3/4" x 69" x 11"	50	\$1,195	\$1,303
--------------	-----------------	-----------------	-------	---------------------	----	---------	---------

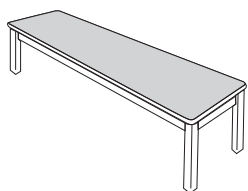

The seat is 3/4" thick edge-banded plywood supported by a 3-1/2" x 3/4" apron on all four sides. Legs attach to the aprons by means of formed 14-gauge steel corner brackets. Each leg is bolted to the corner bracket with two 5/16"-18 hex-head bolts per leg.

Please specify Wood Finish (Table 1) and High-Pressure Laminate (Table 2). Details can be found on page GEN 4.

General Specifications

TOPS – WOOD AND STEEL SHELVING

Tops are 1-3/16" thick, 3-ply, 45# density particleboard core, with a high-pressure laminate top surface .050" thick and a backing sheet .020" thick for balanced construction. The continuous top receives a solid Northern-grown Red Oak or Maple flush edge band, 5/8" x 1-3/16" thick, radius 1/2" to form a bullnosed shape. The maximum width of any shelving top segment is 108". This covers a range of three standard shelving sections. Tops wider than 108" are built in multiple sections by the factory, based on the total number of shelving units in the shelving range. Joints are set so they coincide with the joint in the shelving sections. Tops are splined at the joints so they can be leveled. Tight Joint fastener routes and hardware are provided. Brodart shelving tops overhang approximately 5/8". Single-faced tops are not banded on the back edge.

WOOD SHELVING TOPS

Single-Faced Tops are banded on both ends and on the front edge only. Back edge is not banded. Double-Faced Tops are banded on both ends and on the front and back edges.

STEEL SHELVING TOPS

Single-Faced Tops are banded on the front edge only. Back edge and sides are not banded. Double-Faced Tops are banded on the front and back edges only.

Exact width and depth of steel shelving tops must be specified when ordering.

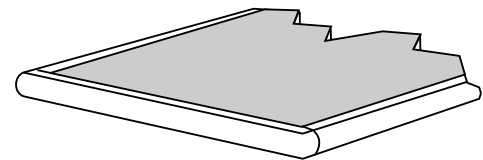
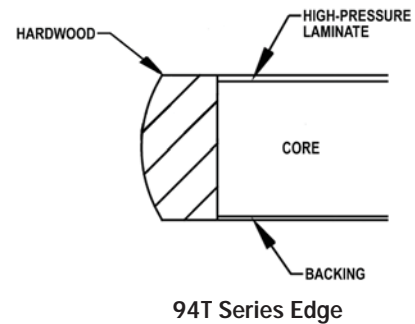

94T Series
External Edge Band

Quorum 94T Collection

Continuous Tops for Wood Shelving

Oak Catalog No.	Maple Catalog No.	Description	Wt. (lbs.)	Oak Price	Maple Price
<i>To Cover ONE UNIT</i>					
94T-W10-S01 OAK	94T-W10-S01 MAP	10"D, Single-Faced	11	\$277	\$291
94T-W12-S01 OAK	94T-W12-S01 MAP	12"D, Single-Faced	14	\$281	\$295
94T-W20-S01 OAK	94T-W20-S01 MAP	20"D, Double-Faced	23	\$393	\$413
94T-W24-S01 OAK	94T-W24-S01 MAP	24"D, Double-Faced	27	\$438	\$459
<i>To Cover TWO UNITS</i>					
94T-W10-S02 OAK	94T-W10-S02 MAP	10"D, Single-Faced	22	\$366	\$384
94T-W12-S02 OAK	94T-W12-S02 MAP	12"D, Single-Faced	28	\$389	\$408
94T-W20-S02 OAK	94T-W20-S02 MAP	20"D, Double-Faced	46	\$551	\$578
94T-W24-S02 OAK	94T-W24-S02 MAP	24"D, Double-Faced	54	\$692	\$727
<i>To Cover THREE UNITS</i>					
94T-W10-S03 OAK	94T-W10-S03 MAP	10"D, Single-Faced	33	\$478	\$502
94T-W12-S03 OAK	94T-W12-S03 MAP	12"D, Single-Faced	42	\$510	\$535
94T-W20-S03 OAK	94T-W20-S03 MAP	20"D, Double-Faced	69	\$694	\$729
94T-W24-S03 OAK	94T-W24-S03 MAP	24"D, Double-Faced	81	\$733	\$770
<i>To Cover FOUR UNITS</i>					
94T-W10-S04 OAK	94T-W10-S04 MAP	10"D, Single-Faced	44	\$730	\$767
94T-W12-S04 OAK	94T-W12-S04 MAP	12"D, Single-Faced	56	\$775	\$814
94T-W20-S04 OAK	94T-W20-S04 MAP	20"D, Double-Faced	92	\$1,087	\$1,142
94T-W24-S04 OAK	94T-W24-S04 MAP	24"D, Double-Faced	108	\$1,170	\$1,228
<i>To Cover FIVE UNITS</i>					
94T-W10-S05 OAK	94T-W10-S05 MAP	10"D, Single-Faced	55	\$843	\$885
94T-W12-S05 OAK	94T-W12-S05 MAP	12"D, Single-Faced	70	\$849	\$944
94T-W20-S05 OAK	94T-W20-S05 MAP	20"D, Double-Faced	115	\$1,245	\$1,307
94T-W24-S05 OAK	94T-W24-S05 MAP	24"D, Double-Faced	135	\$1,426	\$1,497
<i>To Cover SIX UNITS</i>					
94T-W10-S06 OAK	94T-W10-S06 MAP	10"D, Single-Faced	66	\$953	\$1,001
94T-W12-S06 OAK	94T-W12-S06 MAP	12"D, Single-Faced	84	\$1,020	\$1,071
94T-W20-S06 OAK	94T-W20-S06 MAP	20"D, Double-Faced	138	\$1,389	\$1,458
94T-W24-S06 OAK	94T-W24-S06 MAP	24"D, Double-Faced	162	\$1,464	\$1,538
<i>To Cover SEVEN UNITS</i>					
94T-W10-S07 OAK	94T-W10-S07 MAP	10"D, Single-Faced	77	\$1,229	\$1,291
94T-W12-S07 OAK	94T-W12-S07 MAP	12"D, Single-Faced	98	\$1,303	\$1,368
94T-W20-S07 OAK	94T-W20-S07 MAP	20"D, Double-Faced	161	\$1,780	\$1,869
94T-W24-S07 OAK	94T-W24-S07 MAP	24"D, Double-Faced	189	\$1,902	\$1,997
<i>To Cover EIGHT UNITS</i>					
94T-W10-S08 OAK	94T-W10-S08 MAP	10"D, Single-Faced	88	\$1,318	\$1,384
94T-W12-S08 OAK	94T-W12-S08 MAP	12"D, Single-Faced	112	\$1,409	\$1,479
94T-W20-S08 OAK	94T-W20-S08 MAP	20"D, Double-Faced	184	\$1,940	\$2,038
94T-W24-S08 OAK	94T-W24-S08 MAP	24"D, Double-Faced	216	\$2,156	\$2,264
<i>To Cover NINE UNITS</i>					
94T-W10-S09 OAK	94T-W10-S09 MAP	10"D, Single-Faced	99	\$1,432	\$1,503
94T-W12-S09 OAK	94T-W12-S09 MAP	12"D, Single-Faced	126	\$1,530	\$1,606
94T-W20-S09 OAK	94T-W20-S09 MAP	20"D, Double-Faced	207	\$2,084	\$2,189
94T-W24-S09 OAK	94T-W24-S09 MAP	24"D, Double-Faced	243	\$2,195	\$2,305

Note: Single-Faced Tops are banded on both ends and on the front edge only. Back edge is not banded.
Double-Faced Tops are banded on both ends and on the front and back edges.

Please specify Wood Finish (Table 1) and High-Pressure Laminate (Table 2). Details can be found on page GEN 4.

Oak Catalog No.	Maple Catalog No.	Description	Wt. (lbs.)	Oak Price	Maple Price
<u>To Cover ONE UNIT</u>					
94T-S10-S01 OAK	94T-S10-S01 MAP	10"D, Single-Faced	11	\$302	\$317
94T-S12-S01 OAK	94T-S12-S01 MAP	12"D, Single-Faced	14	\$304	\$319
94T-S20-S01 OAK	94T-S20-S01 MAP	20"D, Double-Faced	23	\$425	\$446
94T-S24-S01 OAK	94T-S24-S01 MAP	24"D, Double-Faced	27	\$478	\$502
<u>To Cover TWO UNITS</u>					
94T-S10-S02 OAK	94T-S10-S02 MAP	10"D, Single-Faced	22	\$396	\$416
94T-S12-S02 OAK	94T-S12-S02 MAP	12"D, Single-Faced	28	\$421	\$442
94T-S20-S02 OAK	94T-S20-S02 MAP	20"D, Double-Faced	46	\$599	\$629
94T-S24-S02 OAK	94T-S24-S02 MAP	24"D, Double-Faced	54	\$750	\$788
<u>To Cover THREE UNITS</u>					
94T-S10-S03 OAK	94T-S10-S03 MAP	10"D, Single-Faced	33	\$517	\$543
94T-S12-S03 OAK	94T-S12-S03 MAP	12"D, Single-Faced	42	\$554	\$581
94T-S20-S03 OAK	94T-S20-S03 MAP	20"D, Double-Faced	69	\$755	\$793
94T-S24-S03 OAK	94T-S24-S03 MAP	24"D, Double-Faced	81	\$793	\$832
<u>To Cover FOUR UNITS</u>					
94T-S10-S04 OAK	94T-S10-S04 MAP	10"D, Single-Faced	44	\$796	\$835
94T-S12-S04 OAK	94T-S12-S04 MAP	12"D, Single-Faced	56	\$843	\$885
94T-S20-S04 OAK	94T-S20-S04 MAP	20"D, Double-Faced	92	\$1,125	\$1,181
94T-S24-S04 OAK	94T-S24-S04 MAP	24"D, Double-Faced	108	\$1,271	\$1,334
<u>To Cover FIVE UNITS</u>					
94T-S10-S05 OAK	94T-S10-S05 MAP	10"D, Single-Faced	55	\$911	\$956
94T-S12-S05 OAK	94T-S12-S05 MAP	12"D, Single-Faced	70	\$977	\$1,026
94T-S20-S05 OAK	94T-S20-S05 MAP	20"D, Double-Faced	115	\$1,353	\$1,421
94T-S24-S05 OAK	94T-S24-S05 MAP	24"D, Double-Faced	135	\$1,548	\$1,625
<u>To Cover SIX UNITS</u>					
94T-S10-S06 OAK	94T-S10-S06 MAP	10"D, Single-Faced	66	\$1,033	\$1,084
94T-S12-S06 OAK	94T-S12-S06 MAP	12"D, Single-Faced	84	\$1,112	\$1,168
94T-S20-S06 OAK	94T-S20-S06 MAP	20"D, Double-Faced	138	\$1,509	\$1,584
94T-S24-S06 OAK	94T-S24-S06 MAP	24"D, Double-Faced	162	\$1,589	\$1,669
<u>To Cover SEVEN UNITS</u>					
94T-S10-S07 OAK	94T-S10-S07 MAP	10"D, Single-Faced	77	\$1,311	\$1,376
94T-S12-S07 OAK	94T-S12-S07 MAP	12"D, Single-Faced	98	\$1,394	\$1,470
94T-S20-S07 OAK	94T-S20-S07 MAP	20"D, Double-Faced	161	\$1,948	\$2,046
94T-S24-S07 OAK	94T-S24-S07 MAP	24"D, Double-Faced	189	\$2,067	\$2,171
<u>To Cover EIGHT UNITS</u>					
94T-S10-S08 OAK	94T-S10-S08 MAP	10"D, Single-Faced	88	\$1,432	\$1,503
94T-S12-S08 OAK	94T-S12-S08 MAP	12"D, Single-Faced	112	\$1,530	\$1,606
94T-S20-S08 OAK	94T-S20-S08 MAP	20"D, Double-Faced	184	\$2,107	\$2,213
94T-S24-S08 OAK	94T-S24-S08 MAP	24"D, Double-Faced	216	\$2,342	\$2,459
<u>To Cover NINE UNITS</u>					
94T-S10-S09 OAK	94T-S10-S09 MAP	10"D, Single-Faced	99	\$1,553	\$1,630
94T-S12-S09 OAK	94T-S12-S09 MAP	12"D, Single-Faced	126	\$1,665	\$1,749
94T-S20-S09 OAK	94T-S20-S09 MAP	20"D, Double-Faced	207	\$2,264	\$2,377
94T-S24-S09 OAK	94T-S24-S09 MAP	24"D, Double-Faced	243	\$2,385	\$2,504

Note: Edge Band on long side only. Tops are designed to be inset between end panels. If edge bands are desired on short edges, please enter the part as a modification and specify which bands to be included.

To ensure that tops for steel shelving work with each manufacturer and top method, please specify the exact width and depth of tops. Add 15% for HPL on top and bottom (Steel Shelving ONLY).

Please specify Wood Finish (Table 1) and High-Pressure Laminate (Table 2). Details can be found on page GEN 4.

General Specifications

END PANELS

End panels are 1-3/16" thick, 3-ply particleboard with select oak-veneer faces. All edges are externally banded with 5/8" solid red-oak bullnose edge bands. All edges are eased. End panels are not machined. No fastening hardware is provided with end panels.

End panels for steel shelving with continuous tops or canopy top inset are designed to have the canopy top "inset" between the end panels.

Note: Exact height and depth of panel must be specified when ordering.

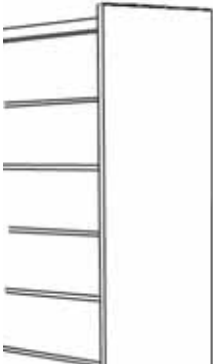
	Oak Catalog No.	Maple Catalog No.	Description	Wt. (lbs.)	Oak Price	Maple Price
	94T-702-MOD OAK	94T-702-MOD MAP	43-3/4" x 13-7/8"	14	\$284	\$298
	94T-703-MOD OAK	94T-703-MOD MAP	43-3/4" x 15-7/8"	16	\$297	\$311
	94T-705-MOD OAK	94T-705-MOD MAP	67-3/4" x 13-7/8"	21	\$364	\$382
	94T-706-MOD OAK	94T-706-MOD MAP	67-3/4" x 15-7/8"	26	\$370	\$389
	94T-708-MOD OAK	94T-708-MOD MAP	79-3/4" x 13-7/8"	25	\$384	\$403
	94T-709-MOD OAK	94T-709-MOD MAP	79-3/4" x 15-7/8"	30	\$390	\$409
	94T-711-MOD OAK	94T-711-MOD MAP	85-3/4" x 13-7/8"	28	\$390	\$409
	94T-712-MOD OAK	94T-712-MOD MAP	85-3/4" x 15-7/8"	33	\$399	\$419
	94T-714-MOD OAK	94T-714-MOD MAP	91-3/4" x 13-7/8"	29	\$399	\$419
	94T-715-MOD OAK	94T-715-MOD MAP	91-3/4" x 15-7/8"	35	\$403	\$423

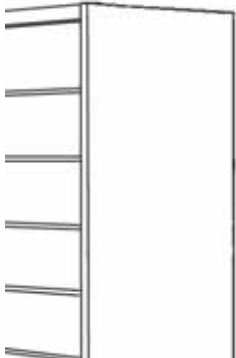
	94T-722-MOD OAK	94T-722-MOD MAP	43-3/4" x 24-3/8"	27	\$364	\$382
	94T-723-MOD OAK	94T-723-MOD MAP	43-3/4" x 28-3/8"	33	\$370	\$389
	94T-725-MOD OAK	94T-725-MOD MAP	67-3/4" x 24-3/8"	43	\$482	\$506
	94T-726-MOD OAK	94T-726-MOD MAP	67-3/4" x 28-3/8"	52	\$497	\$522
	94T-728-MOD OAK	94T-728-MOD MAP	79-3/4" x 24-3/8"	51	\$503	\$528
	94T-729-MOD OAK	94T-729-MOD MAP	79-3/4" x 28-3/8"	61	\$552	\$579
	94T-731-MOD OAK	94T-731-MOD MAP	85-3/4" x 24-3/8"	55	\$506	\$531
	94T-732-MOD OAK	94T-732-MOD MAP	85-3/4" x 28-3/8"	66	\$517	\$543
	94T-734-MOD OAK	94T-734-MOD MAP	91-3/4" x 24-3/8"	59	\$517	\$543
	94T-735-MOD OAK	94T-735-MOD MAP	91-3/4" x 28-3/8"	60	\$526	\$552

Please specify Wood Finish (Table 1). Details can be found on page GEN 4.

General Specifications

TABLETOPS

Tabletops are 1-3/16" thick, 3-ply, 45# density particleboard core with a .050" thick, high-pressure laminate top sheet and a backing sheet not less than .020" thick for balanced construction. High-pressure laminate has a lo-glare finish resistant to scratches, fading, and staining. Edges are solid Northern-grown red oak. The external drop edge band is 5/8" thick x 1-5/8"W, externally banded to form a bullnose.

LEGS

Legs are glued up, 2-1/4" solid Northern-grown red oak, radiused 1/2" on vertical edges. Each leg has a 2" diameter, adjustable glide mounted in a recessed tee-nut. The glide is further recessed into the leg by means of a counter-sunk boring which accepts the upper two-thirds of the glide. Legs attach to tabletops by means of a 5" square x 5/16" thick steel plate. The plate is attached to the leg by a 5/16" x 3" machine bolt engaging a 5/8" diameter barrel nut inserted into the leg. The steel plate is attached to the tabletop by five 5/16" x 1" machine bolts engaging internally and externally threaded steel bushings in the underside of the tabletop. Leg plates are positioned behind, and hidden by the extended table edge band.

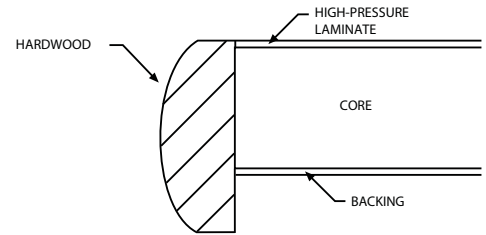

94T Series Drop Edge

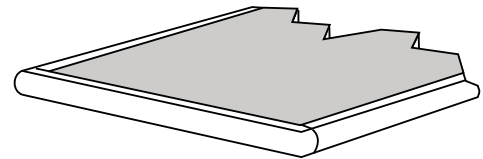

94T Series External Edge Band

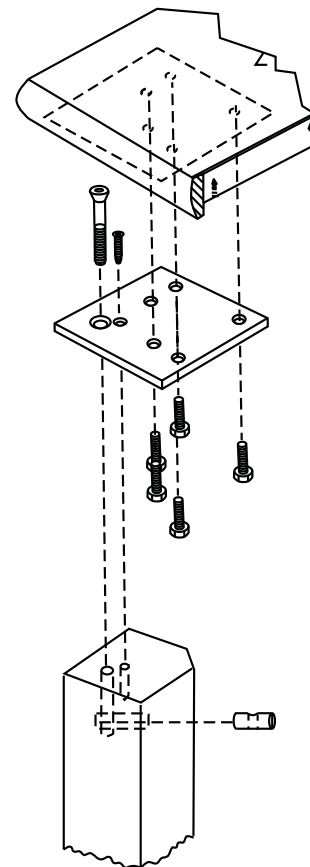

	Oak Catalog No.	Maple Catalog No.	Description	H x W x D	Wt. (lbs.)	Oak Price	Maple Price
Round Table	94T-626-S00 OAK	94T-626-S00 MAP	Round Table	16" H x 36" Diameter	66	\$1,279	\$1,395



Square Table	94T-625-S00 OAK	94T-625-S00 MAP	Square Table	16" x 30" x 30"	51	\$913	\$994
--------------	-----------------	-----------------	--------------	-----------------	----	-------	-------



Rectangular Table	94T-627-S00 OAK	94T-627-S00 MAP	Rectangular Table	16" x 24" x 48"	46	\$929	\$1,013
-------------------	-----------------	-----------------	-------------------	-----------------	----	-------	---------



End Tables	94T-628-S00 OAK	94T-628-S00 MAP	End Table	22" x 24" x 24"	45	\$769	\$838
------------	-----------------	-----------------	-----------	-----------------	----	-------	-------



	94T-629-S00 OAK	94T-629-S00 MAP	End Table	22" x 30" x 24"	48	\$784	\$854
--	-----------------	-----------------	-----------	-----------------	----	-------	-------



Please specify Wood Finish (Table 1) and High-Pressure Laminate (Table 2). Details can be found on page GEN 4.

Array Tables



2017 Price List and Specifications Addendum

Brodart Co. Contract Furniture - Made in USA

280 North Road, Clinton County Industrial Park • McElhattan, PA 17748

Toll-Free: 888-521-1884 • E-Mail: furniture@brodart.com • www.brodartfurniture.com

General Specifications

TABLETOP FOR WOOD VENEER

Tabletop will be 1" thick veneered particleboard, with .020" thick veneer on both faces. Wood veneer tops receive a 1/4" thick x 1"W wood (Maple, Oak or Walnut) edge band.

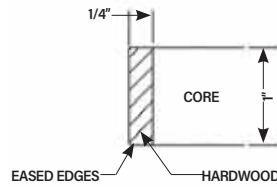

Edge Detail

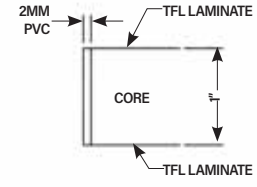

2MM PVC ON TFL
Edge Detail

TABLETOP FOR THERMALLY-FUSED LAMINATE (TFL)

Tabletop will be 1" thick MDF, with .020" thick thermally-fused laminate on both faces. TFL tops receive a PVC edge band which will be flexible polyethylene, 2mm thick x 1"W.

TABLETOP FOR HIGH-PRESSURE LAMINATE (HPL)

Tabletop will be 1" thick particleboard, with .035" thick high-pressure laminate surface and .020" thick backing sheet for balanced construction. High-pressure laminate tops receive a PVC edge band which will be flexible polyethylene, 2mm thick x 1"W or a 5/8" thick x 1-1/16"W wood (Maple or Oak) edge band.

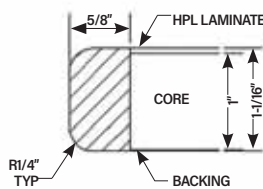

HPL WITH WOOD
Edge Band
Edge Detail

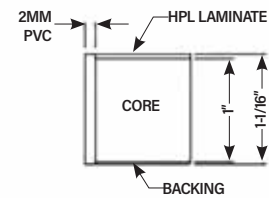

2MM PVC ON HPL
Edge Detail

PATH LEGS (METAL)

Legs will be 2" x 2" steel square tubing with a wall thickness not less than 2mm. Legs are supplied with a standard glide insert. Metal legs attach to table top by means of a flange welded to the leg. Attachment flange will be 3-3/4" x 3-3/4" metal plate formed and welded on two sides to the leg. Each leg attachment flange is attached to the metal apron support frame using four #8 x 3/4" screws and then attached to the underneath of the tabletop by five #12 x 3/4" screws. Legs will be finished with electrostatic applied epoxy powder-coat paint.

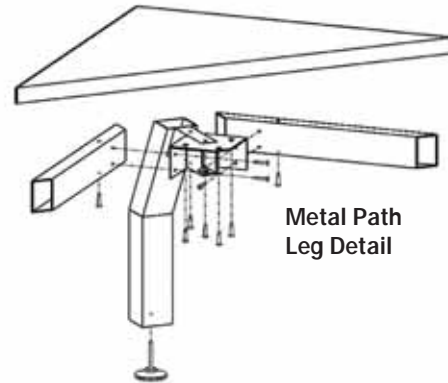

Metal Path
Leg Detail

BLADE LEGS (METAL)

Legs will be 1" x 3" steel rectangular tubing with a wall thickness not less than 2mm. Legs are supplied with a standard glide insert. Metal legs attach to table top by means of a flange welded to the leg. Attachment flange will be 3-3/4" x 3-3/4" metal plate formed and welded on two sides to the leg. Each leg attachment flange is attached to the metal apron support frame using four #8 x 3/4" screws and then attached to the underneath of the tabletop by five #12 x 3/4" screws. Legs will be finished with electrostatic applied epoxy powder-coat paint.

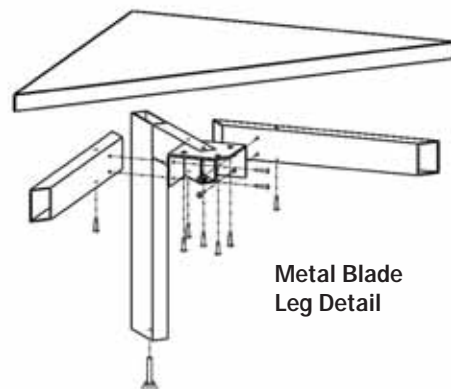

Metal Blade
Leg Detail

APRON SUPPORT FRAME

A metal frame 1"W x 2"H x 2mm thick in various lengths will be attached to underneath of the tabletop using #12 x 3/4" screws. Each leg attachment flange will be attached to the apron support frame using four #8 x 3/4" screws.

Path Legs Catalog No.	Blade Legs Catalog No.	Description	H x W x D	Wt. (lbs.)	Price
<i>Round Table with Veneer Top and Matching Wood Edge Band</i>					
ARYP36RD30VOS	ARYB36RD30VOS	Veneer Oak Top/Edge Band	30"H x 36" Diameter	80	\$1,771
ARYP36RD30VMS	ARYB36RD30VMS	Veneer Maple Top/Edge Band	30"H x 36" Diameter	80	\$1,857
ARYP36RD30VWS	ARYB36RD30VWS	Veneer Walnut Top/Edge Band	30"H x 36" Diameter	80	\$1,991
ARYP42RD30VOS	ARYB42RD30VOS	Veneer Oak Top/Edge Band	30"H x 42" Diameter	85	\$1,851
ARYP42RD30VMS	ARYB42RD30VMS	Veneer Maple Top/Edge Band	30"H x 42" Diameter	85	\$1,937
ARYP42RD30VWS	ARYB42RD30VWS	Veneer Walnut Top/Edge Band	30"H x 42" Diameter	85	\$2,071
ARYP48RD30VOS	ARYB48RD30VOS	Veneer Oak Top/Edge Band	30"H x 48" Diameter	90	\$1,931
ARYP48RD30VMS	ARYB48RD30VMS	Veneer Maple Top/Edge Band	30"H x 48" Diameter	90	\$2,017
ARYP48RD30VWS	ARYB48RD30VWS	Veneer Walnut Top/Edge Band	30"H x 48" Diameter	90	\$2,151
ARYP60RD30VOS	ARYB60RD30VOS	Veneer Oak Top/Edge Band	30"H x 60" Diameter	95	\$2,083
ARYP60RD30VMS	ARYB60RD30VMS	Veneer Maple Top/Edge Band	30"H x 60" Diameter	95	\$2,169
ARYP60RD30VWS	ARYB60RD30VWS	Veneer Walnut Top/Edge Band	30"H x 60" Diameter	95	\$2,378
ARYP36RD42VOS	ARYB36RD42VOS	Veneer Oak Top/Edge Band	42"H x 36" Diameter	90	\$1,771
ARYP36RD42VMS	ARYB36RD42VMS	Veneer Maple Top/Edge Band	42"H x 36" Diameter	90	\$1,857
ARYP36RD42VWS	ARYB36RD42VWS	Veneer Walnut Top/Edge Band	42"H x 36" Diameter	90	\$1,991

Round Table



with Path Legs



with Blade Legs

Please specify Wood Finish for Tabletop and Wood Edge Band (Table 1). Details can be found on page GEN 4.

Round Table with Solid Surface Top

ARYP36RD30SSS	ARYB36RD30SSS	Solid Surface Top	30"H x 36" Diameter		Call for Pricing
ARYP42RD30SSS	ARYB42RD30SSS	Solid Surface Top	30"H x 42" Diameter		Call for Pricing
ARYP48RD30SSS	ARYB48RD30SSS	Solid Surface Top	30"H x 48" Diameter		Call for Pricing
ARYP60RD30SSS	ARYB60RD30SSS	Solid Surface Top	30"H x 60" Diameter		Call for Pricing
ARYP36RD42SSS	ARYB36RD42SSS	Solid Surface Top	42"H x 36" Diameter		Call for Pricing

Please call for details.

Round Table with TFL Top, PVC Edge Band

ARYP36RD30TPS	ARYB36RD30TPS	TFL Top, PVC Edge Band	30"H x 36" Diameter	80	\$1,169
ARYP42RD30TPS	ARYB42RD30TPS	TFL Top, PVC Edge Band	30"H x 42" Diameter	85	\$1,229
ARYP48RD30TPS	ARYB48RD30TPS	TFL Top, PVC Edge Band	30"H x 48" Diameter	90	\$1,298
ARYP60RD30TPS	ARYB60RD30TPS	TFL Top, PVC Edge Band	30"H x 60" Diameter	95	\$1,441
ARYP36RD42TPS	ARYB36RD42TPS	TFL Top, PVC Edge Band	42"H x 36" Diameter	90	\$1,169

Please specify Laminate Color (Tables 2 and 4), Edge Band Color (Table 4) and Metal Leg Color (Table 3).
Details can be found on pages GEN 4 and GEN 5.

Note: Edge Band Color does NOT have to match Laminate Color.

	Path Legs Catalog No.	Blade Legs Catalog No.	Description	H x W x D	Wt. (lbs.)	Price	
 <p>Round Table</p>	<u>Round Table with HPL Top, Maple or Oak Edge Band</u>						
		ARYP36RD30HMS	ARYB36RD30HMS	HPL Top, Maple Edge Band	30"H x 36" Diameter	80	\$1,771
		ARYP36RD30HOS	ARYB36RD30HOS	HPL Top, Oak Edge Band	30"H x 36" Diameter	80	\$1,771
		ARYP42RD30HMS	ARYB42RD30HMS	HPL Top, Maple Edge Band	30"H x 42" Diameter	85	\$1,851
		ARYP42RD30HOS	ARYB42RD30HOS	HPL Top, Oak Edge Band	30"H x 42" Diameter	85	\$1,851
		ARYP48RD30HMS	ARYB48RD30HMS	HPL Top, Maple Edge Band	30"H x 48" Diameter	90	\$1,931
		ARYP48RD30HOS	ARYB48RD30HOS	HPL Top, Oak Edge Band	30"H x 48" Diameter	90	\$1,931
		ARYP60RD30HMS	ARYB60RD30HMS	HPL Top, Maple Edge Band	30"H x 60" Diameter	95	\$2,083
		ARYP60RD30HOS	ARYB60RD30HOS	HPL Top, Oak Edge Band	30"H x 60" Diameter	95	\$2,083
		ARYP36RD42HMS	ARYB36RD42HMS	HPL Top, Maple Edge Band	42"H x 36" Diameter	90	\$1,771
	ARYP36RD42HOS	ARYB36RD42HOS	HPL Top, Oak Edge Band	42"H x 36" Diameter	90	\$1,771	

Please specify Laminate Color (Tables 2 and 4) and Metal Leg Color (Table 3). Details can be found on pages GEN 4 and GEN 5.

with Path Legs



with Blade Legs

	<u>Round Table with HPL Top, PVC Edge Band</u>					
	ARYP36RD30HPS	ARYB36RD30HPS	HPL Top, PVC Edge Band	30"H x 36" Diameter	80	\$1,280
	ARYP42RD30HPS	ARYB42RD30HPS	HPL Top, PVC Edge Band	30"H x 42" Diameter	85	\$1,360
	ARYP48RD30HPS	ARYB48RD30HPS	HPL Top, PVC Edge Band	30"H x 48" Diameter	90	\$1,440
	ARYP60RD30HPS	ARYB60RD30HPS	HPL Top, PVC Edge Band	30"H x 60" Diameter	95	\$1,592
	ARYP36RD42HPS	ARYB36RD42HPS	HPL Top, PVC Edge Band	42"H x 36" Diameter	90	\$1,280

Please specify Laminate Color (Tables 2 and 4), Edge Band Color (Table 4) and Metal Leg Color (Table 3).
Details can be found on pages GEN 4 and GEN 5.

Note: Edge Band Color does NOT have to match Laminate Color.

Path Legs Catalog No.	Blade Legs Catalog No.	Description	H x W x D	Wt. (lbs.)	Price
<i>Square Table with Veneer Top and Matching Wood Edge Band</i>					
ARYP303030VOS	ARYB303030VOS	Veneer Oak Top/Edge Band	30" x 30" x 30"	90	\$1,348
ARYP303030VMS	ARYB303030VMS	Veneer Maple Top/ Edge Band	30" x 30" x 30"	90	\$1,434
ARYP303030VWS	ARYB303030VWS	Veneer Walnut Top/Edge Band	30" x 30" x 30"	90	\$1,568
ARYP424230VOS	ARYB424230VOS	Veneer Oak Top/Edge Band	30" x 42" x 42"	100	\$1,512
ARYP424230VMS	ARYB424230VMS	Veneer Maple Top/Edge Band	30" x 42" x 42"	100	\$1,598
ARYP424230VWS	ARYB424230VWS	Veneer Walnut Top/Edge Band	30" x 42" x 42"	100	\$1,732
ARYP484830VOS	ARYB484830VOS	Veneer Oak Top/Edge Band	30" x 48" x 48"	110	\$1,612
ARYP484830VMS	ARYB484830VMS	Veneer Maple Top/Edge Band	30" x 48" x 48"	110	\$1,698
ARYP484830VWS	ARYB484830VWS	Veneer Walnut Top/Edge Band	30" x 48" x 48"	110	\$1,832
ARYP424236VOS	ARYB424236VOS	Veneer Oak Top/Edge Band	36" x 42" x 42"	105	\$1,512
ARYP424236VMS	ARYB424236VMS	Veneer Maple Top/Edge Band	36" x 42" x 42"	105	\$1,598
ARYP424236VWS	ARYB424236VWS	Veneer Walnut Top/Edge Band	36" x 42" x 42"	105	\$1,732
ARYP484836VOS	ARYB484836VOS	Veneer Oak Top/Edge Band	36" x 48" x 48"	115	\$1,612
ARYP484836VMS	ARYB484836VMS	Veneer Maple Top/Edge Band	36" x 48" x 48"	115	\$1,698
ARYP484836VWS	ARYB484836VWS	Veneer Walnut Top/Edge Band	36" x 48" x 48"	115	\$1,832
ARYP303042VOS	ARYB303042VOS	Veneer Oak Top/Edge Band	42" x 30" x 30"	100	\$1,348
ARYP303042VMS	ARYB303042VMS	Veneer Maple Top/Edge Band	42" x 30" x 30"	100	\$1,434
ARYP303042VWS	ARYB303042VWS	Veneer Walnut Top/Edge Band	42" x 30" x 30"	100	\$1,568

Square Table



with Path Legs



with Blade Legs

Please specify Wood Finish for Tabletop and Wood Edge Band (Table 1). Details can be found on page GEN 4.

Square Table with Solid Surface Top

ARYP303030SSS	ARYB303030SSS	Solid Surface Top	30" x 30" x 30"		Call for Pricing
ARYP424230SSS	ARYB424230SSS	Solid Surface Top	30" x 42" x 42"		Call for Pricing
ARYP484830SSS	ARYB484830SSS	Solid Surface Top	30" x 48" x 48"		Call for Pricing
ARYP424236SSS	ARYB424236SSS	Solid Surface Top	36" x 42" x 42"		Call for Pricing
ARYP484836SSS	ARYB484836SSS	Solid Surface Top	36" x 48" x 48"		Call for Pricing
ARYP303042SSS	ARYB303042SSS	Solid Surface Top	42" x 30" x 30"		Call for Pricing

Please call for details.

Square Table with TFL Top, PVC Edge Band

ARYP303030TPS	ARYB303030TPS	TFL Top, PVC Edge Band	30" x 30" x 30"	90	\$1,073
ARYP424230TPS	ARYB424230TPS	TFL Top, PVC Edge Band	30" x 42" x 42"	100	\$1,182
ARYP484830TPS	ARYB484830TPS	TFL Top, PVC Edge Band	30" x 48" x 48"	110	\$1,282
ARYP424236TPS	ARYB424236TPS	TFL Top, PVC Edge Band	36" x 42" x 42"	105	\$1,182
ARYP484836TPS	ARYB484836TPS	TFL Top, PVC Edge Band	36" x 48" x 48"	115	\$1,282
ARYP303042TPS	ARYB303042TPS	TFL Top, PVC Edge Band	42" x 30" x 30"	100	\$1,073

Please specify Laminate Color (Tables 2 and 4), Edge Band Color (Table 4) and Metal Leg Color (Table 3).
Details can be found on pages GEN 4 and GEN 5.

Note: Edge Band Color does NOT have to match Laminate Color.

	Path Legs Catalog No.	Blade Legs Catalog No.	Description	H x W x D	Wt. (lbs.)	Price
Square Table	<u>Square Table with HPL Top, Maple or Oak Edge Band</u>					
	ARYP303030HMS	ARYB303030HMS	HPL Top, Maple Edge Band	30" x 30" x 30"	90	\$1,348
	ARYP303030HOS	ARYB303030HOS	HPL Top, Oak Edge Band	30" x 30" x 30"	90	\$1,348
	ARYP424230HMS	ARYB424230HMS	HPL Top, Maple Edge Band	30" x 42" x 42"	100	\$1,512
	ARYP424230HOS	ARYB424230HOS	HPL Top, Oak Edge Band	30" x 42" x 42"	100	\$1,512
	ARYP484830HMS	ARYB484830HMS	HPL Top, Maple Edge Band	30" x 48" x 48"	110	\$1,612
	ARYP484830HOS	ARYB484830HOS	HPL Top, Oak Edge Band	30" x 48" x 48"	110	\$1,612
	ARYP424236HMS	ARYB424236HMS	HPL Top, Maple Edge Band	36" x 42" x 42"	105	\$1,512
	ARYP424236HOS	ARYB424236HOS	HPL Top, Oak Edge Band	36" x 42" x 42"	105	\$1,512
	ARYP484836HMS	ARYB484836HMS	HPL Top, Maple Edge Band	36" x 48" x 48"	115	\$1,612
	ARYP484836HOS	ARYB484836HOS	HPL Top, Oak Edge Band	36" x 48" x 48"	115	\$1,612
with Path Legs	ARYP303042HMS	ARYB303042HMS	HPL Top, Maple Edge Band	42" x 30" x 30"	100	\$1,348
	ARYP303042HOS	ARYB303042HOS	HPL Top, Oak Edge Band	42" x 30" x 30"	100	\$1,348

Please specify Laminate Color (Tables 2 and 4) and Metal Leg Color (Table 3). Details can be found on pages GEN 4 and GEN 5.



with Blade Legs

Square Table with HPL Top, PVC Edge Band

ARYP303030HPS	ARYB303030HPS	HPL Top, PVC Edge Band	30" x 30" x 30"	90	\$1,147
ARYP424230HPS	ARYB424230HPS	HPL Top, PVC Edge Band	30" x 42" x 42"	100	\$1,311
ARYP484830HPS	ARYB484830HPS	HPL Top, PVC Edge Band	30" x 48" x 48"	110	\$1,411
ARYP424236HPS	ARYB424236HPS	HPL Top, PVC Edge Band	36" x 42" x 42"	105	\$1,311
ARYP484836HPS	ARYB484836HPS	HPL Top, PVC Edge Band	36" x 48" x 48"	115	\$1,411
ARYP303042HPS	ARYB303042HPS	HPL Top, PVC Edge Band	42" x 30" x 30"	100	\$1,147

Please specify Laminate Color (Tables 2 and 4), Edge Band Color (Table 4) and Metal Leg Color (Table 3).
Details can be found on pages GEN 4 and GEN 5.

Note: Edge Band Color does NOT have to match Laminate Color.

Path Legs Catalog No.	Blade Legs Catalog No.	Description	H x W x D	Wt. (lbs.)	Price
<i>Rectangular Table with Veneer Top and Matching Wood Edge Band</i>					
ARYP306030VOS	ARYB306030VOS	Veneer Oak Top/Edge Band	30" x 60" x 30"	96	\$1,648
ARYP306030VMS	ARYB306030VMS	Veneer Maple Top/Edge Band	30" x 60" x 30"	96	\$1,772
ARYP306030VWS	ARYB306030VWS	Veneer Walnut Top/Edge Band	30" x 60" x 30"	96	\$1,907
ARYP307230VOS	ARYB307230VOS	Veneer Oak Top/Edge Band	30" x 72" x 30"	110	\$1,783
ARYP307230VMS	ARYB307230VMS	Veneer Maple Top/Edge Band	30" x 72" x 30"	110	\$1,907
ARYP307230VWS	ARYB307230VWS	Veneer Walnut Top/Edge Band	30" x 72" x 30"	110	\$2,041
ARYP309030VOS	ARYB309030VOS	Veneer Oak Top/Edge Band	30" x 90" x 30"	120	\$1,948
ARYP309030VMS	ARYB309030VMS	Veneer Maple Top/Edge Band	30" x 90" x 30"	120	\$2,072
ARYP309030VWS	ARYB309030VWS	Veneer Walnut Top/Edge Band	30" x 90" x 30"	120	\$2,206
ARYP366030VOS	ARYB366030VOS	Veneer Oak Top/Edge Band	30" x 60" x 36"	104	\$1,717
ARYP366030VMS	ARYB366030VMS	Veneer Maple Top/Edge Band	30" x 60" x 36"	104	\$1,846
ARYP366030VWS	ARYB366030VWS	Veneer Walnut Top/Edge Band	30" x 60" x 36"	104	\$1,986
ARYP367230VOS	ARYB367230VOS	Veneer Oak Top/Edge Band	30" x 72" x 36"	118	\$1,857
ARYP367230VMS	ARYB367230VMS	Veneer Maple Top/Edge Band	30" x 72" x 36"	118	\$1,986
ARYP367230VWS	ARYB367230VWS	Veneer Walnut Top/Edge Band	30" x 72" x 36"	118	\$2,126
ARYP369030VOS	ARYB369030VOS	Veneer Oak Top/Edge Band	30" x 90" x 36"	128	\$2,029
ARYP369030VMS	ARYB369030VMS	Veneer Maple Top/Edge Band	30" x 90" x 36"	128	\$2,158
ARYP369030VWS	ARYB369030VWS	Veneer Walnut Top/Edge Band	30" x 90" x 36"	128	\$2,298
ARYP426030VOS	ARYB426030VOS	Veneer Oak Top/Edge Band	30" x 60" x 42"	110	\$1,830
ARYP426030VMS	ARYB426030VMS	Veneer Maple Top/Edge Band	30" x 60" x 42"	110	\$1,968
ARYP426030VWS	ARYB426030VWS	Veneer Walnut Top/Edge Band	30" x 60" x 42"	110	\$2,117
ARYP427230VOS	ARYB427230VOS	Veneer Oak Top/Edge Band	30" x 72" x 42"	124	\$1,980
ARYP427230VMS	ARYB427230VMS	Veneer Maple Top/Edge Band	30" x 72" x 42"	124	\$2,117
ARYP427230VWS	ARYB427230VWS	Veneer Walnut Top/Edge Band	30" x 72" x 42"	124	\$2,266
ARYP429030VOS	ARYB429030VOS	Veneer Oak Top/Edge Band	30" x 90" x 42"	135	\$2,163
ARYP429030VMS	ARYB429030VMS	Veneer Maple Top/Edge Band	30" x 90" x 42"	135	\$2,300
ARYP429030VWS	ARYB429030VWS	Veneer Walnut Top/Edge Band	30" x 90" x 42"	135	\$2,450
ARYP4210830VOS	ARYB4210830VOS	Veneer Oak Top/Edge Band	30" x 108" x 42"	145	\$2,487
ARYP4210830VMS	ARYB4210830VMS	Veneer Maple Top/Edge Band	30" x 108" x 42"	145	\$2,587
ARYP4210830VWS	ARYB4210830VWS	Veneer Walnut Top/Edge Band	30" x 108" x 42"	145	\$2,727
ARYP4212030VOS	ARYB4212030VOS	Veneer Oak Top/Edge Band	30" x 120" x 42"	155	\$2,626
ARYP4212030VMS	ARYB4212030VMS	Veneer Maple Top/Edge Band	30" x 120" x 42"	155	\$2,803
ARYP4212030VWS	ARYB4212030VWS	Veneer Walnut Top/Edge Band	30" x 120" x 42"	155	\$2,927
ARYP244836VOS	ARYB244836VOS	Veneer Oak Top/Edge Band	36" x 48" x 24"	85	\$1,441
ARYP244836VMS	ARYB244836VMS	Veneer Maple Top/Edge Band	36" x 48" x 24"	85	\$1,549
ARYP244836VWS	ARYB244836VWS	Veneer Walnut Top/Edge Band	36" x 48" x 24"	85	\$1,666
ARYP246036VOS	ARYB246036VOS	Veneer Oak Top and Edge Band	36" x 60" x 24"	96	\$1,516
ARYP246036VMS	ARYB246036VMS	Veneer Maple Top and Edge Band	36" x 60" x 24"	96	\$1,630
ARYP246036VWS	ARYB246036VWS	Veneer Walnut Top and Edge Band	36" x 60" x 24"	96	\$1,754
ARYP247236VOS	ARYB247236VOS	Veneer Oak Top/Edge Band	36" x 72" x 24"	110	\$1,640
ARYP247236VMS	ARYB247236VMS	Veneer Maple Top/Edge Band	36" x 72" x 24"	110	\$1,754
ARYP247236VWS	ARYB247236VWS	Veneer Walnut Top/Edge Band	36" x 72" x 24"	110	\$1,878
ARYP249036VOS	ARYB249036VOS	Veneer Oak Top/Edge Band	36" x 90" x 24"	120	\$1,792
ARYP249036VMS	ARYB249036VMS	Veneer Maple Top/Edge Band	36" x 90" x 24"	120	\$1,906
ARYP249036VWS	ARYB249036VWS	Veneer Walnut Top/Edge Band	36" x 90" x 24"	120	\$2,030
ARYP306036VOS	ARYB306036VOS	Veneer Oak Top/Edge Band	36" x 60" x 30"	100	\$1,648
ARYP306036VMS	ARYB306036VMS	Veneer Maple Top/Edge Band	36" x 60" x 30"	100	\$1,772
ARYP306036VWS	ARYB306036VWS	Veneer Walnut Top/Edge Band	36" x 60" x 30"	100	\$1,907
ARYP307236VOS	ARYB307236VOS	Veneer Oak Top/Edge Band	36" x 72" x 30"	115	\$1,783
ARYP307236VMS	ARYB307236VMS	Veneer Maple Top/Edge Band	36" x 72" x 30"	115	\$1,907
ARYP307236VWS	ARYB307236VWS	Veneer Walnut Top/Edge Band	36" x 72" x 30"	115	\$2,041

Rectangular Table



with Path Legs



with Blade Legs

Please specify Wood Finish for Tabletop and Wood Edge Band (Table 1). Details can be found on page GEN 4.

	Path Legs Catalog No.	Blade Legs Catalog No.	Description	H x W x D	Wt. (lbs.)	Price
Rectangular Table	<u>Rectangular Table with Veneer Top and Matching Wood Edge Band</u>					
	ARYP309036VOS	ARYB309036VOS	Veneer Oak Top/Edge Band	36" x 90" x 30"	125	\$1,948
	ARYP309036VMS	ARYB309036VMS	Veneer Maple Top/Edge Band	36" x 90" x 30"	125	\$2,072
	ARYP309036VWS	ARYB309036VWS	Veneer Walnut Top/Edge Band	36" x 90" x 30"	125	\$2,206
	ARYP426036VOS	ARYB426036VOS	Veneer Oak Top/Edge Band	36" x 60" x 42"	115	\$1,830
	ARYP426036VMS	ARYB426036VMS	Veneer Maple Top/Edge Band	36" x 60" x 42"	115	\$1,968
	ARYP426036VWS	ARYB426036VWS	Veneer Walnut Top/Edge Band	36" x 60" x 42"	115	\$2,117
	ARYP427236VOS	ARYB427236VOS	Veneer Oak Top/Edge Band	36" x 72" x 42"	129	\$1,980
	ARYP427236VMS	ARYB427236VMS	Veneer Maple Top/Edge Band	36" x 72" x 42"	129	\$2,117
	ARYP427236VWS	ARYB427236VWS	Veneer Walnut Top/Edge Band	36" x 72" x 42"	129	\$2,266
	with Path Legs	ARYP429036VOS	ARYB429036VOS	Veneer Oak Top/Edge Band	36" x 90" x 42"	140
	ARYP429036VMS	ARYB429036VMS	Veneer Maple Top/Edge Band	36" x 90" x 42"	140	\$2,300
	ARYP429036VWS	ARYB429036VWS	Veneer Walnut Top/Edge Band	36" x 90" x 42"	140	\$2,450
	ARYP4210836VOS	ARYB4210836VOS	Veneer Oak Top/Edge Band	36" x 108" x 42"	150	\$2,487
	ARYP4210836VMS	ARYB4210836VMS	Veneer Maple Top/Edge Band	36" x 108" x 42"	150	\$2,587
	ARYP4210836VWS	ARYB4210836VWS	Veneer Walnut Top/Edge Band	36" x 108" x 42"	150	\$2,727
	ARYP4212036VOS	ARYB4212036VOS	Veneer Oak Top/Edge Band	36" x 120" x 42"	160	\$2,626
	ARYP4212036VMS	ARYB4212036VMS	Veneer Maple Top/Edge Band	36" x 120" x 42"	160	\$2,803
	ARYP4212036VWS	ARYB4212036VWS	Veneer Walnut Top/Edge Band	36" x 120" x 42"	160	\$2,927
	ARYP244842VOS	ARYB244842VOS	Veneer Oak Top/Edge Band	42" x 48" x 24"	90	\$1,441
	ARYP244842VMS	ARYB244842VMS	Veneer Maple Top/Edge Band	42" x 48" x 24"	90	\$1,549
	ARYP244842VWS	ARYB244842VWS	Veneer Walnut Top/Edge Band	42" x 48" x 24"	90	\$1,666
	with Blade Legs	ARYP246042VOS	ARYB246042VOS	Veneer Oak Top/Edge Band	42" x 60" x 24"	101
	ARYP246042VMS	ARYB246042VMS	Veneer Maple Top/Edge Band	42" x 60" x 24"	101	\$1,549
	ARYP246042VWS	ARYB246042VWS	Veneer Walnut Top/Edge Band	42" x 60" x 24"	101	\$1,666
	ARYP247242VOS	ARYB247242VOS	Veneer Oak Top/Edge Band	42" x 72" x 24"	115	\$1,640
	ARYP247242VMS	ARYB247242VMS	Veneer Maple Top/Edge Band	42" x 72" x 24"	115	\$1,754
	ARYP247242VWS	ARYB247242VWS	Veneer Walnut Top/Edge Band	42" x 72" x 24"	115	\$1,878
	ARYP249042VOS	ARYB249042VOS	Veneer Oak Top/Edge Band	42" x 90" x 24"	125	\$1,792
	ARYP249042VMS	ARYB249042VMS	Veneer Maple Top/Edge Band	42" x 90" x 24"	125	\$1,906
	ARYP249042VWS	ARYB249042VWS	Veneer Walnut Top/Edge Band	42" x 90" x 24"	125	\$2,030

Please specify Wood Finish for Tabletop and Wood Edge Band (Table 1). Details can be found on page GEN 4.

Rectangular with Solid Surface Top

ARYP306030SSS	ARYB306030SSS	Solid Surface Top	30" x 60" x 30"	Call for Pricing
ARYP307230SSS	ARYB307230SSS	Solid Surface Top	30" x 72" x 30"	Call for Pricing
ARYP309030SSS	ARYB309030SSS	Solid Surface Top	30" x 90" x 30"	Call for Pricing
ARYP366030SSS	ARYB366030SSS	Solid Surface Top	30" x 60" x 36"	Call for Pricing
ARYP367230SSS	ARYB367230SSS	Solid Surface Top	30" x 72" x 36"	Call for Pricing
ARYP369030SSS	ARYB369030SSS	Solid Surface Top	30" x 90" x 36"	Call for Pricing
ARYP426030SSS	ARYB426030SSS	Solid Surface Top	30" x 60" x 42"	Call for Pricing
ARYP427230SSS	ARYB427230SSS	Solid Surface Top	30" x 72" x 42"	Call for Pricing
ARYP429030SSS	ARYB429030SSS	Solid Surface Top	30" x 90" x 42"	Call for Pricing
ARYP4210830SSS	ARYB4210830SSS	Solid Surface Top	30" x 108" x 42"	Call for Pricing
ARYP4212030SSS	ARYB4212030SSS	Solid Surface Top	30" x 120" x 42"	Call for Pricing
ARYP244836SSS	ARYB244836SSS	Solid Surface Top	36" x 48" x 24"	Call for Pricing
ARYP246036SSS	ARYB246036SSS	Solid Surface Top	36" x 60" x 24"	Call for Pricing
ARYP247236SSS	ARYB247236SSS	Solid Surface Top	36" x 72" x 24"	Call for Pricing

Please call for details.

Path Legs Catalog No.	Blade Legs Catalog No.	Description	H x W x D	Wt. (lbs.)	Price
<i>Rectangular with Solid Surface Top</i>					
ARYP249036SSS	ARYB249036SSS	Solid Surface Top	36" x 90" x 24"		Call for Pricing
ARYP306036SSS	ARYB306036SSS	Solid Surface Top	36" x 60" x 30"		Call for Pricing
ARYP307236SSS	ARYB307236SSS	Solid Surface Top	36" x 72" x 30"		Call for Pricing
ARYP309036SSS	ARYB309036SSS	Solid Surface Top	36" x 90" x 30"		Call for Pricing
ARYP426036SSS	ARYB426036SSS	Solid Surface Top	36" x 60" x 42"		Call for Pricing
ARYP427236SSS	ARYB427236SSS	Solid Surface Top	36" x 72" x 42"		Call for Pricing
ARYP429036SSS	ARYB429036SSS	Solid Surface Top	36" x 90" x 42"		Call for Pricing
ARYP4210836SSS	ARYB4210836SSS	Solid Surface Top	36" x 108" x 42"		Call for Pricing
ARYP4212036SSS	ARYB4212036SSS	Solid Surface Top	36" x 120" x 42"		Call for Pricing
ARYP244842SSS	ARYB244842SSS	Solid Surface Top	42" x 48" x 24"		Call for Pricing
ARYP246042SSS	ARYB246042SSS	Solid Surface Top	42" x 60" x 24"		Call for Pricing
ARYP247242SSS	ARYB247242SSS	Solid Surface Top	42" x 72" x 24"		Call for Pricing
ARYP249042SSS	ARYB249042SSS	Solid Surface Top	42" x 90" x 24"		Call for Pricing

Please call for details.

Rectangular Table



with Path Legs



with Blade Legs

<i>Rectangular Table with TFL Top, PVC Edge Band</i>					
ARYP306030TPS	ARYB306030TPS	TFL Top, PVC Edge Band	30" x 60" x 30"	96	\$1,246
ARYP307230TPS	ARYB307230TPS	TFL Top, PVC Edge Band	30" x 72" x 30"	110	\$1,317
ARYP309030TPS	ARYB309030TPS	TFL Top, PVC Edge Band	30" x 90" x 30"	120	\$1,462
ARYP366030TPS	ARYB366030TPS	TFL Top, PVC Edge Band	30" x 60" x 36"	104	\$1,298
ARYP367230TPS	ARYB367230TPS	TFL Top, PVC Edge Band	30" x 72" x 36"	118	\$1,372
ARYP369030TPS	ARYB369030TPS	TFL Top, PVC Edge Band	30" x 90" x 36"	128	\$1,523
ARYP426030TPS	ARYB426030TPS	TFL Top, PVC Edge Band	30" x 60" x 42"	110	\$1,384
ARYP427230TPS	ARYB427230TPS	TFL Top, PVC Edge Band	30" x 72" x 42"	124	\$1,463
ARYP429030TPS	ARYB429030TPS	TFL Top, PVC Edge Band	30" x 90" x 42"	135	\$1,624
ARYP4210830TPS	ARYB4210830TPS	TFL Top, PVC Edge Band	30" x 108" x 42"	145	\$1,866
ARYP4212030TPS	ARYB4212030TPS	TFL Top, PVC Edge Band	30" x 120" x 42"	155	\$1,998
ARYP244836TPS	ARYB244836TPS	TFL Top, PVC Edge Band	36" x 48" x 24"	85	\$1,089
ARYP246036TPS	ARYB246036TPS	TFL Top, PVC Edge Band	36" x 60" x 24"	96	\$1,146
ARYP247236TPS	ARYB247236TPS	TFL Top, PVC Edge Band	36" x 72" x 24"	110	\$1,212
ARYP249036TPS	ARYB249036TPS	TFL Top, PVC Edge Band	36" x 90" x 24"	120	\$1,345
ARYP306036TPS	ARYB306036TPS	TFL Top, PVC Edge Band	36" x 60" x 30"	100	\$1,246
ARYP307236TPS	ARYB307236TPS	TFL Top, PVC Edge Band	36" x 72" x 30"	115	\$1,317
ARYP309036TPS	ARYB309036TPS	TFL Top, PVC Edge Band	36" x 90" x 30"	125	\$1,462
ARYP426036TPS	ARYB426036TPS	TFL Top, PVC Edge Band	36" x 60" x 42"	115	\$1,384
ARYP427236TPS	ARYB427236TPS	TFL Top, PVC Edge Band	36" x 72" x 42"	129	\$1,463
ARYP429036TPS	ARYB429036TPS	TFL Top, PVC Edge Band	36" x 90" x 42"	140	\$1,624
ARYP4210836TPS	ARYB4210836TPS	TFL Top, PVC Edge Band	36" x 108" x 42"	150	\$1,866

Please specify Laminate Color (Tables 2 and 4), Edge Band Color (Table 4) and Metal Leg Color (Table 3).
Details can be found on pages GEN 4 and GEN 5.

Note: Edge Band Color does NOT have to match Laminate Color.

	Path Legs Catalog No.	Blade Legs Catalog No.	Description	H x W x D	Wt. (lbs.)	Price
 <p>Rectangular Table</p>	<i>Rectangular Table with TFL Top, PVC Edge Band</i>					
	ARYP4212036TPS	ARYB4212036TPS	TFL Top, PVC Edge Band	36" x 120" x 42"	160	\$1,998
	ARYP244842TPS	ARYB244842TPS	TFL Top, PVC Edge Band	42" x 48" x 24"	90	\$1,089
	ARYP246042TPS	ARYB246042TPS	TFL Top, PVC Edge Band	42" x 60" x 24"	101	\$1,146
	ARYP247242TPS	ARYB247242TPS	TFL Top, PVC Edge Band	42" x 72" x 24"	115	\$1,212
	ARYP249042TPS	ARYB249042TPS	TFL Top, PVC Edge Band	42" x 90" x 24"	125	\$1,345

Please specify Laminate Color (Tables 2 and 4), Edge Band Color (Table 4) and Metal Leg Color (Table 3).
Details can be found on pages GEN 4 and GEN 5.

Note: Edge Band Color does NOT have to match Laminate Color. GEN 5.

with Path Legs



with Blade Legs

	Path Legs Catalog No.	Blade Legs Catalog No.	Description	H x W x D	Wt. (lbs.)	Price	
 <p>Rectangular Table</p>	<i>Rectangular Table with HPL Top, Maple or Oak Edge Band</i>						
	ARYP306030HMS	ARYB306030HMS	HPL Top, Maple Edge Band	30" x 60" x 30"	96	\$1,648	
	ARYP306030HOS	ARYB306030HOS	HPL Top, Oak Edge Band	30" x 60" x 30"	96	\$1,648	
		ARYP307230HMS	ARYB307230HMS	HPL Top, Maple Edge Band	30" x 72" x 30"	110	\$1,783
		ARYP307230HOS	ARYB307230HOS	HPL Top, Oak Edge Band	30" x 72" x 30"	110	\$1,783
		ARYP309030HMS	ARYB309030HMS	HPL Top, Maple Edge Band	30" x 90" x 30"	120	\$1,948
		ARYP309030HOS	ARYB309030HOS	HPL Top, Oak Edge Band	30" x 90" x 30"	120	\$1,948
		ARYP366030HMS	ARYB366030HMS	HPL Top, Maple Edge Band	30" x 60" x 36"	104	\$1,717
		ARYP366030HOS	ARYB366030HOS	HPL Top, Oak Edge Band	30" x 60" x 36"	104	\$1,717
		ARYP367230HMS	ARYB367230HMS	HPL Top, Maple Edge Band	30" x 72" x 36"	118	\$1,857
		ARYP367230HOS	ARYB367230HOS	HPL Top, Oak Edge Band	30" x 72" x 36"	118	\$1,857
		ARYP369030HMS	ARYB369030HMS	HPL Top, Maple Edge Band	30" x 90" x 36"	128	\$2,029
		ARYP369030HOS	ARYB369030HOS	HPL Top, Oak Edge Band	30" x 90" x 36"	128	\$2,029
		ARYP426030HMS	ARYB426030HMS	HPL Top, Maple Edge Band	30" x 60" x 42"	110	\$1,830
		ARYP426030HOS	ARYB426030HOS	HPL Top, Oak Edge Band	30" x 60" x 42"	110	\$1,830
		ARYP427230HMS	ARYB427230HMS	HPL Top, Maple Edge Band	30" x 72" x 42"	124	\$1,980
		ARYP427230HOS	ARYB427230HOS	HPL Top, Oak Edge Band	30" x 72" x 42"	124	\$1,980
		ARYP429030HMS	ARYB429030HMS	HPL Top, Maple Edge Band	30" x 90" x 42"	135	\$2,163
		ARYP429030HOS	ARYB429030HOS	HPL Top, Oak Edge Band	30" x 90" x 42"	135	\$2,163
		ARYP4210830HMS	ARYB4210830HMS	HPL Top, Maple Edge Band	30" x 108" x 42"	145	\$2,487
		ARYP4210830HOS	ARYB4210830HOS	HPL Top, Oak Edge Band	30" x 108" x 42"	145	\$2,487
		ARYP4212030HMS	ARYB4212030HMS	HPL Top, Maple Edge Band	30" x 120" x 42"	155	\$2,626
		ARYP4212030HOS	ARYB4212030HOS	HPL Top, Oak Edge Band	30" x 120" x 42"	155	\$2,626
		ARYP244836HMS	ARYB244836HMS	HPL Top, Maple Edge Band	36" x 48" x 24"	85	\$1,441
		ARYP244836HOS	ARYB244836HOS	HPL Top, Oak Edge Band	36" x 48" x 24"	85	\$1,441
		ARYP246036HMS	ARYB246036HMS	HPL Top, Maple Edge Band	36" x 60" x 24"	96	\$1,516
		ARYP246036HOS	ARYB246036HOS	HPL Top, Oak Edge Band	36" x 60" x 24"	96	\$1,516
		ARYP247236HMS	ARYB247236HMS	HPL Top, Maple Edge Band	36" x 72" x 24"	110	\$1,640
		ARYP247236HOS	ARYB247236HOS	HPL Top, Oak Edge Band	36" x 72" x 24"	110	\$1,640
		ARYP249036HMS	ARYB249036HMS	HPL Top, Maple Edge Band	36" x 90" x 24"	120	\$1,792
		ARYP249036HOS	ARYB249036HOS	HPL Top, Oak Edge Band	36" x 90" x 24"	120	\$1,792
		ARYP306036HMS	ARYB306036HMS	HPL Top, Maple Edge Band	36" x 60" x 30"	100	\$1,648
		ARYP306036HOS	ARYB306036HOS	HPL Top, Oak Edge Band	36" x 60" x 30"	100	\$1,648
	ARYP307236HMS	ARYB307236HMS	HPL Top, Maple Edge Band	36" x 72" x 30"	115	\$1,783	
	ARYP307236HOS	ARYB307236HOS	HPL Top, Oak Edge Band	36" x 72" x 30"	115	\$1,783	
	ARYP309036HMS	ARYB309036HMS	HPL Top, Maple Edge Band	36" x 90" x 30"	125	\$1,948	
	ARYP309036HOS	ARYB309036HOS	HPL Top, Oak Edge Band	36" x 90" x 30"	125	\$1,948	

Please specify Laminate Color (Tables 2 and 4) and Metal Leg Color (Table 3). Details can be found on pages GEN 4 and GEN 5.

Path Legs Catalog No.	Blade Legs Catalog No.	Description	H x W x D	Wt. (lbs.)	Price
<i>Rectangular Table with HPL Top, Maple or Oak Edge Band</i>					
ARYP426036HMS	ARYB426036HMS	HPL Top, Maple Edge Band	36" x 60" x 42"	115	\$1,830
ARYP426036HOS	ARYB426036HOS	HPL Top, Oak Edge Band	36" x 60" x 42"	115	\$1,830
ARYP427236HMS	ARYB427236HMS	HPL Top, Maple Edge Band	36" x 72" x 42"	129	\$1,980
ARYP427236HOS	ARYB427236HOS	HPL Top, Oak Edge Band	36" x 72" x 42"	129	\$1,980
ARYP429036HMS	ARYB429036HMS	HPL Top, Maple Edge Band	36" x 90" x 42"	140	\$2,163
ARYP429036HOS	ARYB429036HOS	HPL Top, Oak Edge Band	36" x 90" x 42"	140	\$2,163
ARYP4210836HMS	ARYB4210836HMS	HPL Top, Maple Edge Band	36" x 108" x 42"	150	\$2,487
ARYP4210836HOS	ARYB4210836HOS	HPL Top, Oak Edge Band	36" x 108" x 42"	150	\$2,487
ARYP4212036HMS	ARYB4212036HMS	HPL Top, Maple Edge Band	36" x 120" x 42"	160	\$2,626
ARYP4212036HOS	ARYB4212036HOS	HPL Top, Oak Edge Band	36" x 120" x 42"	160	\$2,626
ARYP244842HMS	ARYB244842HMS	HPL Top, Maple Edge Band	42" x 48" x 24"	90	\$1,441
ARYP244842HOS	ARYB244842HOS	HPL Top, Oak Edge Band	42" x 48" x 24"	90	\$1,441
ARYP246042HMS	ARYB246042HMS	HPL Top, Maple Edge Band	42" x 60" x 24"	101	\$1,516
ARYP246042HOS	ARYB246042HOS	HPL Top, Oak Edge Band	42" x 60" x 24"	101	\$1,516
ARYP247242HMS	ARYB247242HMS	HPL Top, Maple Edge Band	42" x 72" x 24"	115	\$1,640
ARYP247242HOS	ARYB247242HOS	HPL Top, Oak Edge Band	42" x 72" x 24"	115	\$1,640
ARYP249042HMS	ARYB249042HMS	HPL Top, Maple Edge Band	42" x 90" x 24"	125	\$1,792
ARYP249042HOS	ARYB249042HOS	HPL Top, Oak Edge Band	42" x 90" x 24"	125	\$1,792

Rectangular Table



with Path Legs



with Blade Legs

Please specify Laminate Color (Tables 2 and 4) and Metal Leg Color (Table 3). Details can be found on pages GEN 4 and GEN 5.

Rectangular Table with HPL Top, PVC Edge Band

ARYP306030HPS	ARYB306030HPS	HPL Top, PVC Edge Band	30" x 60" x 30"	96	\$1,375
ARYP307230HPS	ARYB307230HPS	HPL Top, PVC Edge Band	30" x 72" x 30"	110	\$1,490
ARYP309030HPS	ARYB309030HPS	HPL Top, PVC Edge Band	30" x 90" x 30"	120	\$1,636
ARYP366030HPS	ARYB366030HPS	HPL Top, PVC Edge Band	30" x 60" x 36"	104	\$1,432
ARYP367230HPS	ARYB367230HPS	HPL Top, PVC Edge Band	30" x 72" x 36"	118	\$1,552
ARYP369030HPS	ARYB369030HPS	HPL Top, PVC Edge Band	30" x 90" x 36"	128	\$1,704
ARYP426030HPS	ARYB426030HPS	HPL Top, PVC Edge Band	30" x 60" x 42"	110	\$1,527
ARYP427230HPS	ARYB427230HPS	HPL Top, PVC Edge Band	30" x 72" x 42"	124	\$1,654
ARYP429030HPS	ARYB429030HPS	HPL Top, PVC Edge Band	30" x 90" x 42"	135	\$1,816
ARYP4210830HPS	ARYB4210830HPS	HPL Top, PVC Edge Band	30" x 108" x 42"	145	\$2,080
ARYP4212030HPS	ARYB4212030HPS	HPL Top, PVC Edge Band	30" x 120" x 42"	155	\$2,237
ARYP244836HPS	ARYB244836HPS	HPL Top, PVC Edge Band	36" x 48" x 24"	85	\$1,202
ARYP246036HPS	ARYB246036HPS	HPL Top, PVC Edge Band	36" x 60" x 24"	96	\$1,265
ARYP247236HPS	ARYB247236HPS	HPL Top, PVC Edge Band	36" x 72" x 24"	110	\$1,371
ARYP249036HPS	ARYB249036HPS	HPL Top, PVC Edge Band	36" x 90" x 24"	120	\$1,505
ARYP306036HPS	ARYB306036HPS	HPL Top, PVC Edge Band	36" x 60" x 30"	100	\$1,375
ARYP307236HPS	ARYB307236HPS	HPL Top, PVC Edge Band	36" x 72" x 30"	115	\$1,490
ARYP309036HPS	ARYB309036HPS	HPL Top, PVC Edge Band	36" x 90" x 30"	125	\$1,636
ARYP426036HPS	ARYB426036HPS	HPL Top, PVC Edge Band	36" x 60" x 42"	115	\$1,527
ARYP427236HPS	ARYB427236HPS	HPL Top, PVC Edge Band	36" x 72" x 42"	129	\$1,654

Please specify Laminate Color (Tables 2 and 4), Edge Band Color (Table 4) and Metal Leg Color (Table 3).
Details can be found on pages GEN 4 and GEN 5.

Note: Edge Band Color does NOT have to match Laminate Color.

	Path Legs Catalog No.	Blade Legs Catalog No.	Description	H x W x D	Wt. (lbs.)	Price
Rectangular Table	<u>Rectangular Table with HPL Top, PVC Edge Band</u>					
	ARYP429036HPS	ARYB429036HPS	HPL Top, PVC Edge Band	36" x 90" x 42"	140	\$1,816
	ARYP4210836HPS	ARYB4210836HPS	HPL Top, PVC Edge Band	36" x 108" x 42"	150	\$2,080
	ARYP4212036HPS	ARYB4212036HPS	HPL Top, PVC Edge Band	36" x 120" x 42"	160	\$2,237
	ARYP244842HPS	ARYB244842HPS	HPL Top, PVC Edge Band	42" x 48" x 24"	90	\$1,202
	ARYP246042HPS	ARYB246042HPS	HPL Top, PVC Edge Band	42" x 60" x 24"	101	\$1,265
	ARYP247242HPS	ARYB247242HPS	HPL Top, PVC Edge Band	42" x 72" x 24"	115	\$1,371
	ARYP249042HPS	ARYB249042HPS	HPL Top, PVC Edge Band	42" x 90" x 24"	125	\$1,505

with Path Legs

Please specify Laminate Color (Tables 2 and 4), Edge Band Color (Table 4) and Metal Leg Color (Table 3).
Details can be found on pages GEN 4 and GEN 5.

Note: Edge Band Color does NOT have to match Laminate Color.



with Blade Legs

The mTable™ Collection



2017 Price List and Specifications

Brodart Co. Contract Furniture - Made in USA

280 North Road, Clinton County Industrial Park • McElhattan, PA 17748

Toll-Free: 888-521-1884 • E-Mail: furniture@brodart.com • www.brodartfurniture.com

General Specifications

TABLETOP

Tabletop is 1-3/16" thick, 9-ply solid hardwood plywood or 3-ply 45# density particleboard, with a high-pressure laminate top surface .050" thick and a backing sheet .020" thick for balanced construction. Edges are solid Northern-grown Red Oak or maple. Top receives an external solid drop edge Northern-grown Red Oak or maple band 5/8" x 1-5/8" thick, radiused to form a bullnose.

APRON (Optional)

A 1-3/4" W x 25/32" Northern-grown Red Oak or maple apron is fitted between the legs and behind the extended tabletop edge band. A 1/4" styling line, routed into the apron, highlights the tabletop and legs. The bottom edge and both ends of each apron receive a 1/2" radius. Aprons are attached to the table using wood cleats screwed to the underside of the tabletop. Aprons on round tables go straight between the legs.

LEGS

Legs are 2-3/8" round steel tubing with a wall thickness not less than .64". Legs are finished with electrostatically applied epoxy powder paint. Legs are supplied with a standard glide insert. Lockable caster inserts interchange with the glide insert on any leg. Table legs are attached to the tabletop by means of a flange welded to the leg tube. The attachment flange is 4-5/8" in diameter formed and welded on two sides. The leg flange is attached to the tabletop by six (6) 1/4"-20 x 1" bolts engaging 1/4" internally and externally threaded bushings embedded in the underside of the tabletop.

CASTERS (Optional)

When specified, a three-inch black nylon hooded twin-wheel caster with a brake is supplied. Lockable caster inserts interchange with the glide insert on any leg. Add one caster per table leg (sold each).

TABLETOP SUPPORT

For maximum rigidity, rectangular tables 60" wide or more receive a V-shaped, 14-gauge steel keel securely fastened to the underside of the tabletop. Tables 48"D and more than 60"W, receive two steel keels parallel to the length of the table. Tables 90" or wider receive two extra legs located under the center of the table to provide added support.

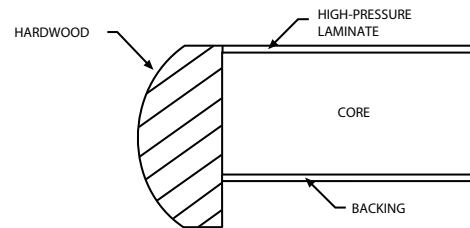

MT Series Drop Edge

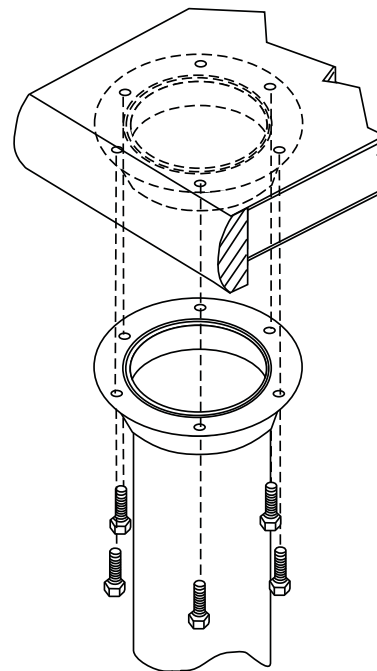

mTable Leg Detail

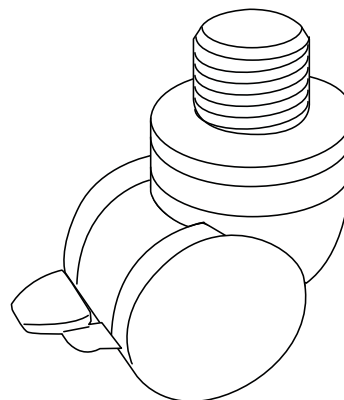

MTCASTER

Plywood Core Catalog No.	Particleboard Core Catalog No.	Description	H x W x D	Wt. (lbs.)	Plywood Core Price	Particleboard Core Price
Round Oak Table						
MT-109-S00 OAK	MT-109-S02 OAK	Adult Table	29"H x 36" Diameter	100	\$1,866	\$1,640
MT-Y09-S00 OAK	MT-Y09-S02 OAK	Youth Table	27-1/2"H x 36" Diameter	100	\$1,866	\$1,640
MT-J09-S00 OAK	MT-J09-S02 OAK	Juvenile Table	25"H x 36" Diameter	100	\$1,866	\$1,640
MT-129-S00 OAK	MT-129-S02 OAK	Adult Table	29"H x 42" Diameter	110	\$1,998	\$1,771
MT-Y29-S00 OAK	MT-Y29-S02 OAK	Youth Table	27-1/2"H x 42" Diameter	110	\$1,998	\$1,771
MT-J29-S00 OAK	MT-J29-S02 OAK	Juvenile Table	25"H x 42" Diameter	110	\$1,998	\$1,771
MT-141-S00 OAK	MT-141-S02 OAK	Adult Table	29"H x 48" Diameter	120	\$1,998	\$1,771
MT-Y41-S00 OAK	MT-Y41-S02 OAK	Youth Table	27-1/2"H x 48" Diameter	120	\$1,998	\$1,771
MT-J41-S00 OAK	MT-J41-S02 OAK	Juvenile Table	25"H x 48" Diameter	120	\$1,998	\$1,771

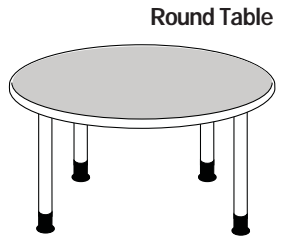

Round Maple Table

MT-109-S00 MAP	MT-109-S02 MAP	Adult Table	29"H x 36" Diameter	100	\$2,034	\$1,788
MT-Y09-S00 MAP	MT-Y09-S02 MAP	Youth Table	27-1/2"H x 36" Diameter	100	\$2,034	\$1,788
MT-J09-S00 MAP	MT-J09-S02 MAP	Juvenile Table	25"H x 36" Diameter	100	\$2,034	\$1,788
MT-129-S00 MAP	MT-129-S02 MAP	Adult Table	29"H x 42" Diameter	110	\$2,178	\$1,931
MT-Y29-S00 MAP	MT-Y29-S02 MAP	Youth Table	27-1/2"H x 42" Diameter	110	\$2,178	\$1,931
MT-J29-S00 MAP	MT-J29-S02 MAP	Juvenile Table	25"H x 42" Diameter	110	\$2,178	\$1,931
MT-141-S00 MAP	MT-141-S02 MAP	Adult Table	29"H x 48" Diameter	120	\$2,178	\$1,931
MT-Y41-S00 MAP	MT-Y41-S02 MAP	Youth Table	27-1/2"H x 48" Diameter	120	\$2,178	\$1,931
MT-J41-S00 MAP	MT-J41-S02 MAP	Juvenile Table	25"H x 48" Diameter	120	\$2,178	\$1,931

Square Oak Table

MT-191-S00 OAK	MT-191-S02 OAK	Adult Table	29" x 30" x 30"	110	\$1,647	\$1,405
MT-Y91-S00 OAK	MT-Y91-S02 OAK	Youth Table	27-1/2" x 30" x 30"	110	\$1,647	\$1,405
MT-J91-S00 OAK	MT-J91-S02 OAK	Juvenile Table	25" x 30" x 30"	110	\$1,647	\$1,405
MT-137-S00 OAK	MT-137-S02 OAK	Adult Table	29" x 42" x 42"	110	\$1,778	\$1,537
MT-Y37-S00 OAK	MT-Y37-S02 OAK	Youth Table	27-1/2" x 42" x 42"	110	\$1,778	\$1,537
MT-J37-S00 OAK	MT-J37-S02 OAK	Juvenile Table	25" x 42" x 42"	110	\$1,778	\$1,537
MT-154-S00 OAK	MT-154-S02 OAK	Adult Table	29" x 48" x 48"	110	\$1,925	\$1,684
MT-Y54-S00 OAK	MT-Y54-S02 OAK	Youth Table	27-1/2" x 48" x 48"	110	\$1,925	\$1,684
MT-J54-S00 OAK	MT-J54-S02 OAK	Juvenile Table	25" x 48" x 48"	110	\$1,925	\$1,684

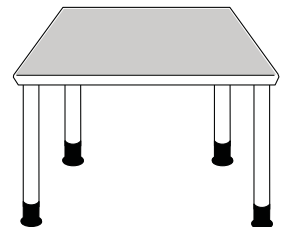

Square Maple Table

MT-191-S00 MAP	MT-191-S02 MAP	Adult Table	29" x 30" x 30"	110	\$1,795	\$1,532
MT-Y91-S00 MAP	MT-Y91-S02 MAP	Youth Table	27-1/2" x 30" x 30"	110	\$1,795	\$1,532
MT-J91-S00 MAP	MT-J91-S02 MAP	Juvenile Table	25" x 30" x 30"	110	\$1,795	\$1,532
MT-137-S00 MAP	MT-137-S02 MAP	Adult Table	29" x 42" x 42"	110	\$1,939	\$1,675
MT-Y37-S00 MAP	MT-Y37-S02 MAP	Youth Table	27-1/2" x 42" x 42"	110	\$1,939	\$1,675
MT-J37-S00 MAP	MT-J37-S02 MAP	Juvenile Table	25" x 42" x 42"	110	\$1,939	\$1,675
MT-154-S00 MAP	MT-154-S02 MAP	Adult Table	29" x 48" x 48"	110	\$2,099	\$1,835
MT-Y54-S00 MAP	MT-Y54-S02 MAP	Youth Table	27-1/2" x 48" x 48"	110	\$2,099	\$1,835
MT-J54-S00 MAP	MT-J54-S02 MAP	Juvenile Table	25" x 48" x 48"	110	\$2,099	\$1,835

Catalog No.	Description	Price
MT-CASTER	Caster add-on to make any table mobile. 3-inch black nylon hooded twin-wheel caster with a brake. Add one caster per table leg (sold each).	\$28

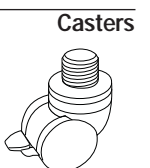

Please specify Wood Finish (Table 1), High-Pressure Laminate (Table 2) and Metal Color (Table 3). Details can be found on pages GEN 4 and GEN 5.

Note: Optional Wood Aprons for Tables are located on page MTA 6.

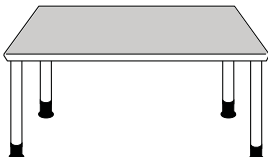
	Plywood Core Catalog No.	Particleboard Core Catalog No.	Description	H x W x D	Wt. (lbs.)	Plywood Core Price	Particleboard Core Price
 <p>Four-Reader Rectrangular Table</p>	<i>Four-Reader Rectangular Oak Table</i>						
	MT-194-S00 OAK	MT-194-S02 OAK	Adult Table	29" x 60" x 30"	120	\$1,664	\$1,442
	MT-Y94-S00 OAK	MT-Y94-S02 OAK	Youth Table	27-1/2" x 60" x 30"	120	\$1,664	\$1,442
	MT-J94-S00 OAK	MT-J94-S02 OAK	Juvenile Table	25" x 60" x 30"	120	\$1,664	\$1,442
	MT-195-S00 OAK	MT-195-S02 OAK	Adult Table	29" x 72" x 30"	140	\$1,844	\$1,603
	MT-Y95-S00 OAK	MT-Y95-S02 OAK	Youth Table	27-1/2" x 72" x 30"	140	\$1,844	\$1,603
	MT-J95-S00 OAK	MT-J95-S02 OAK	Juvenile Table	25" x 72" x 30"	140	\$1,844	\$1,603

Four-Reader Rectangular Maple Table

MT-194-S00 MAP	MT-194-S02 MAP	Adult Table	29" x 60" x 30"	120	\$1,813	\$1,572
MT-Y94-S00 MAP	MT-Y94-S02 MAP	Youth Table	27-1/2" x 60" x 30"	120	\$1,813	\$1,572
MT-J94-S00 MAP	MT-J94-S02 MAP	Juvenile Table	25" x 60" x 30"	120	\$1,813	\$1,572
MT-195-S00 MAP	MT-195-S02 MAP	Adult Table	29" x 72" x 30"	140	\$2,011	\$1,747
MT-Y95-S00 MAP	MT-Y95-S02 MAP	Youth Table	27-1/2" x 72" x 30"	140	\$2,011	\$1,747
MT-J95-S00 MAP	MT-J95-S02 MAP	Juvenile Table	25" x 72" x 30"	140	\$2,011	\$1,747

Six-Reader
Rectrangular Table

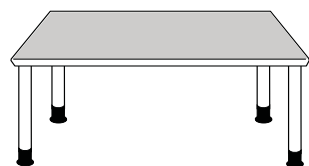

Six-Reader Rectangular Oak Table

MT-144-S00 OAK	MT-144-S02 OAK	Adult Table	29" x 60" x 36"	120	\$1,752	\$1,530
MT-Y44-S00 OAK	MT-Y44-S02 OAK	Youth Table	27-1/2" x 60" x 36"	120	\$1,752	\$1,530
MT-J44-S00 OAK	MT-J44-S02 OAK	Juvenile Table	25" x 60" x 36"	120	\$1,752	\$1,530
MT-138-S00 OAK	MT-138-S02 OAK	Adult Table	29" x 72" x 36"	140	\$1,932	\$1,691
MT-Y38-S00 OAK	MT-Y38-S02 OAK	Youth Table	27-1/2" x 72" x 36"	140	\$1,932	\$1,691
MT-J38-S00 OAK	MT-J38-S02 OAK	Juvenile Table	25" x 72" x 36"	140	\$1,932	\$1,691
MT-145-S00 OAK	MT-145-S02 OAK	Adult Table	29" x 72" x 48"	170	\$2,108	\$1,881
MT-Y45-S00 OAK	MT-Y45-S02 OAK	Youth Table	27-1/2" x 72" x 48"	170	\$2,108	\$1,881
MT-J45-S00 OAK	MT-J45-S02 OAK	Juvenile Table	25" x 72" x 48"	170	\$2,108	\$1,881

Six-Reader Rectangular Maple Table

MT-144-S00 MAP	MT-144-S02 MAP	Adult Table	29" x 60" x 36"	120	\$1,909	\$1,667
MT-Y44-S00 MAP	MT-Y44-S02 MAP	Youth Table	27-1/2" x 60" x 36"	120	\$1,909	\$1,667
MT-J44-S00 MAP	MT-J44-S02 MAP	Juvenile Table	25" x 60" x 36"	120	\$1,909	\$1,667
MT-138-S00 MAP	MT-138-S02 MAP	Adult Table	29" x 72" x 36"	140	\$2,106	\$1,843
MT-Y38-S00 MAP	MT-Y38-S02 MAP	Youth Table	27-1/2" x 72" x 36"	140	\$2,106	\$1,843
MT-J38-S00 MAP	MT-J38-S02 MAP	Juvenile Table	25" x 72" x 36"	140	\$2,106	\$1,843
MT-145-S00 MAP	MT-145-S02 MAP	Adult Table	29" x 72" x 48"	170	\$2,298	\$2,051
MT-Y45-S00 MAP	MT-Y45-S02 MAP	Youth Table	27-1/2" x 72" x 48"	170	\$2,298	\$2,051
MT-J45-S00 MAP	MT-J45-S02 MAP	Juvenile Table	25" x 72" x 48"	170	\$2,298	\$2,051

Catalog No.	Description	Price
-------------	-------------	-------

Casters

MT-CASTER	Caster add-on to make any table mobile. 3-inch black nylon hooded twin-wheel caster with a brake. Add one caster per table leg (sold each).	\$28
-----------	---	------

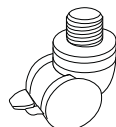

Please specify Wood Finish (Table 1), High-Pressure Laminate (Table 2) and Metal Color (Table 3). Details can be found on pages GEN 4 and GEN 5.

Note: Optional Wood Aprons for Tables are located on page MTA 6.

Plywood Core Catalog No.	Particleboard Core Catalog No.	Description	H x W x D	Wt. (lbs.)	Plywood Core Price	Particleboard Core Price
<i>Rectangular Oak Table with Center Support Legs</i>						
MT-198-S00 OAK	MT-198-S02 OAK	Adult Table	29" x 90" x 30"	165	\$2,517	\$2,181
MT-Y98-S00 OAK	MT-Y98-S02 OAK	Youth Table	27-1/2" x 90" x 30"	165	\$2,517	\$2,181
MT-J98-S00 OAK	MT-J98-S02 OAK	Juvenile Table	25" x 90" x 30"	165	\$2,517	\$2,181
MT-146-S00 OAK	MT-146-S02 OAK	Adult Table	29" x 90" x 36"	165	\$2,606	\$2,269
MT-Y46-S00 OAK	MT-Y46-S02 OAK	Youth Table	27-1/2" x 90" x 36"	165	\$2,606	\$2,269
MT-J46-S00 OAK	MT-J46-S02 OAK	Juvenile Table	25" x 90" x 36"	165	\$2,606	\$2,269
MT-134-S00 OAK	MT-134-S02 OAK	Adult Table	29" x 90" x 48"	185	\$2,781	\$2,423
MT-Y34-S00 OAK	MT-Y34-S02 OAK	Youth Table	27-1/2" x 90" x 48"	185	\$2,781	\$2,423
MT-J34-S00 OAK	MT-J34-S02 OAK	Juvenile Table	25" x 90" x 48"	185	\$2,781	\$2,423

Rectangular Table with Center Support Legs

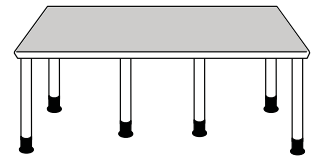

Rectangular Maple Table with Center Support Legs

MT-198-S00 MAP	MT-198-S02 MAP	Adult Table	29" x 90" x 30"	165	\$2,744	\$2,377
MT-Y98-S00 MAP	MT-Y98-S02 MAP	Youth Table	27-1/2" x 90" x 30"	165	\$2,744	\$2,377
MT-J98-S00 MAP	MT-J98-S02 MAP	Juvenile Table	25" x 90" x 30"	165	\$2,744	\$2,377
MT-146-S00 MAP	MT-146-S02 MAP	Adult Table	29" x 90" x 36"	165	\$2,841	\$2,473
MT-Y46-S00 MAP	MT-Y46-S02 MAP	Youth Table	27-1/2" x 90" x 36"	165	\$2,841	\$2,473
MT-J46-S00 MAP	MT-J46-S02 MAP	Juvenile Table	25" x 90" x 36"	165	\$2,841	\$2,473
MT-134-S00 MAP	MT-134-S02 MAP	Adult Table	29" x 90" x 48"	185	\$3,032	\$2,641
MT-Y34-S00 MAP	MT-Y34-S02 MAP	Youth Table	27-1/2" x 90" x 48"	185	\$3,032	\$2,641
MT-J34-S00 MAP	MT-J34-S02 MAP	Juvenile Table	25" x 90" x 48"	185	\$3,032	\$2,641

Catalog No.	Description	Price
MT-CASTER	Caster add-on to make any table mobile. 3-inch black nylon hooded twin-wheel caster with a brake. Add one caster per table leg (sold each).	\$28

Casters

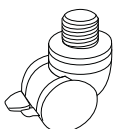

Please specify Wood Finish (Table 1), High-Pressure Laminate (Table 2) and Metal Color (Table 3). Details can be found on pages GEN 4 and GEN 5.

Note: Optional Wood Aprons for Tables are located on page MTA 6.

Optional Wood Apron for Reading Tables

Note: A 1-3/4" W x 25/32" Northern-grown Red Oak or maple apron is fitted between the legs and behind the extended tabletop edge band. A 1/4" styling line, routed into the apron, highlights the tabletop and legs. The bottom edge and both ends of each apron receive a 1/2" radius. Aprons are attached to the table using wood cleats screwed to the underside of the tabletop. Aprons on round tables go straight between the legs.

Oak Catalog No.	Maple Catalog No.	Description	Wt. (lbs.)	Oak Price	Maple Price
109-AK-S00 OAK	109-AK-S00 MAP	For 36" Diameter Table	5	\$208	\$228
129-AK-S00 OAK	129-AK-S00 MAP	For 42" Diameter Table	5	\$208	\$228
141-AK-S00 OAK	141-AK-S00 MAP	For 48" Diameter Table	5	\$215	\$234
191-AK-S00 OAK	191-AK-S00 MAP	For 30" Square Table	5	\$146	\$159
137-AK-S00 OAK	137-AK-S00 MAP	For 42" Square Table	5	\$155	\$168
154-AK-S00 OAK	154-AK-S00 MAP	For 48" Square Table	5	\$170	\$185
194-AK-S00 OAK	194-AK-S00 MAP	For 30" x 60" Table	5	\$175	\$190
195-AK-S00 OAK	195-AK-S00 MAP	For 30" x 72" Table	5	\$190	\$207
198-AK-S00 OAK	198-AK-S00 MAP	For 30" x 90" Table	5	\$194	\$211
144-AK-S00 OAK	144-AK-S00 MAP	For 36" x 60" Table	8	\$181	\$197
138-AK-S00 OAK	138-AK-S00 MAP	For 36" x 72" Table	8	\$198	\$216
146-AK-S00 OAK	146-AK-S00 MAP	For 36" x 90" Table	10	\$198	\$216
145-AK-S00 OAK	145-AK-S00 MAP	For 48" x 72" Table	10	\$208	\$228
134-AK-S00 OAK	134-AK-S00 MAP	For 48" x 90" Table	12	\$215	\$234

Please specify Wood Finish (Table 1). Details can be found on page GEN 4.

General Specifications

TABLETOPS

Tabletop is 1-3/16" thick, 3-ply 45# density particle board, with a high-pressure laminate top surface .050" thick and a backing sheet .020" thick for balanced construction. Edges are solid Northern-grown Red Oak or maple. Top receives an external solid drop edge Northern-grown Red Oak or maple band 5/8" x 1-5/8" thick, radiused to form a bullnose.

Note: Standing Height Tables are Apron construction.

TABLE SUPPORT

For maximum rigidity, rectangular tables 60" or more wide receive a V-shaped, 14-gauge steel keel securely fastened to the underside of the tabletop. Tables 48"D and more than 60"W, receive two steel keels parallel to the length of the table. Tables 72" or wider receive two extra legs located under the center of the table to provide added support.

LEGS

Legs are 2-3/8" round steel tubing with a wall thickness not less than .64". Legs are finished with electrostatically applied epoxy-powder paint. Legs are supplied with a standard glide insert. Lockable caster inserts interchange with the glide insert on any leg. Table legs are attached to the tabletop by means of a flange welded to the leg tube. The attachment flange is 4-5/8" in diameter formed and welded on two sides. The leg flange is attached to the tabletop by six (6) 1/4" - 20 x 1" bolts engaging 1/4" internally and externally threaded bushings embedded in the underside of the tabletop.

CASTER (OPTIONAL)

When specified, a three-inch black nylon hooded twin-wheel caster with a brake is supplied. Lockable caster inserts interchange with the glide insert on any leg. Add one caster per table leg (sold each).

PRIVACY PANEL

Privacy panels are 10"H, constructed of 1" thick, 3-ply veneered particleboard. Exposed edges are banded with 1.6mm oak or maple edge bands. The privacy panel attaches securely to the tabletop by screws passing through the tabletop and into the privacy panels. The privacy panel is finished to match the table and designed to obscure wires exiting computer equipment, to eliminate incidental tampering and create defined patron space.

Note: 72"W and 90"W tables with privacy panels have additional legs for added support.

APRON (OPTIONAL)

A 1-3/4"W x 25/32" solid Northern-grown Red Oak or maple apron is fitted between the legs and behind the extended tabletop edge band. A 1/4" styling line, routed into the apron, highlights the tabletop and legs. The bottom edge and both ends of each apron receive a 1/2" radius. Aprons are attached to the table using wood cleats screwed to the underside of the tabletop. Aprons on round tables go straight between the legs.

ELECTRICAL

Each position on a Computer Table receives one 3" diameter grommet for wire passage and J-channel wire manager to hold excess wires. Grommets are ABS black plastic with notched removable cap. J-channel is 18-gauge steel with electro-statically applied black powder paint and is mounted to the underside of the tabletop.

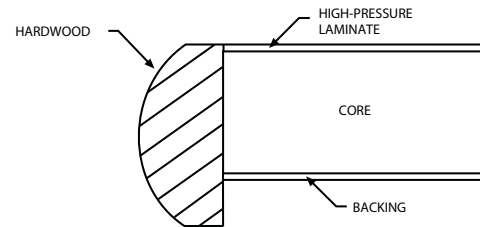

MT Series Drop Edge

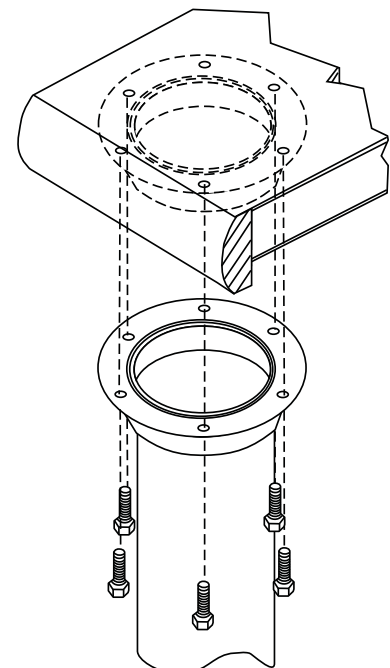

mTable Leg Detail

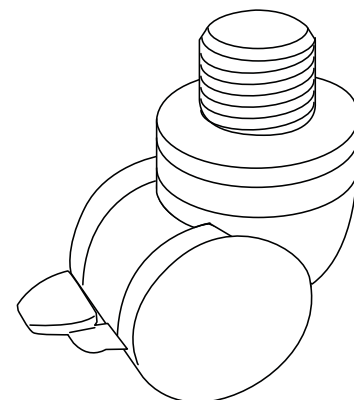

MTCASTER

	Oak Catalog No.	Maple Catalog No.	H x W x D	Wt. (lbs.)	Oak Price	Maple Price
One Position Computer Tables	MT-645-S00 OAK	MT-645-S00 MAP	27-1/2" x 30" x 24"	80	\$1,434	\$1,563
	MT-665-S00 OAK	MT-665-S00 MAP	27-1/2" x 30" x 30"	80	\$1,524	\$1,661

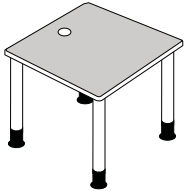

Two Position Computer Tables	MT-649-S00 OAK	MT-649-S00 MAP	27-1/2" x 60" x 24"	110	\$2,049	\$2,233
	MT-669-S00 OAK	MT-669-S00 MAP	27-1/2" x 60" x 30"	110	\$2,196	\$2,394

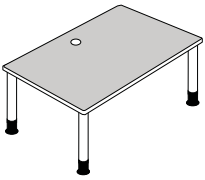

One Position Computer Table with 10"H Privacy Panel	MT-643-S00 OAK	MT-643-S00 MAP	27-1/2" x 36" x 24"	70	\$1,786	\$1,948
	MT-663-S00 OAK	MT-663-S00 MAP	27-1/2" x 36" x 36"	80	\$1,932	\$2,107

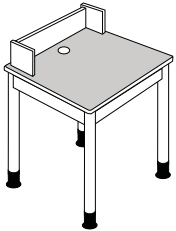

Two Position Computer Table with 10"H Privacy Panel	MT-642-S00 OAK	MT-642-S00 MAP	27-1/2" x 72" x 24"	150	\$2,401	\$2,616
	MT-662-S00 OAK	MT-662-S00 MAP	27-1/2" x 72" x 36"	150	\$2,547	\$2,776

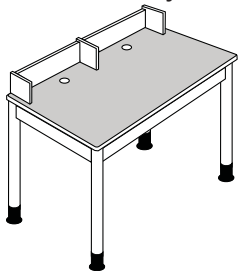

Three Position Computer Table with 10"H Privacy Panel	MT-644-S00 OAK	MT-644-S00 MAP	27-1/2" x 90" x 24"	180	\$3,272	\$3,566
	MT-664-S00 OAK	MT-664-S00 MAP	27-1/2" x 90" x 36"	170	\$3,418	\$3,726

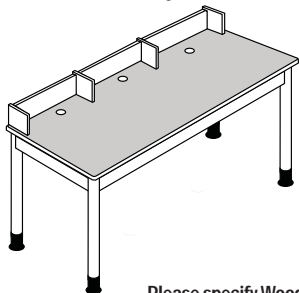

Please specify Wood Finish (Table 1), High-Pressure Laminate (Table 2) and Metal Color (Table 3). Details can be found on pages GEN 4 and GEN 5.

Mobile Tables



2017 Price List and Specifications

Brodart Co. Contract Furniture - Made in USA

280 North Road, Clinton County Industrial Park • McElhattan, PA 17748

Toll-Free: 888-521-1884 • E-Mail: furniture@brodart.com • www.brodartfurniture.com

General Specifications

TABLETOP

Tabletop will be 1-3/16" thick, 3-ply 45# density particleboard, with .050" thick high-pressure laminate surface and .020" thick backing sheet for balanced construction. Edges will be flexible polyethylene tee mold, 5/16" thick x 1-1/4" wide. Core material receives a 5/64" x 3/8" route to receive tee mold. Tee mold is applied to core material after the laminate and backer sheet.

LEGS (WOOD)

Legs are 2-1/2" round solid Northern-grown red oak. Bottom edges of legs are radiused 1/8". Each leg has a 2" diameter, adjustable glide mounted in a recessed tee-nut. The glide is further recessed into the leg by means of a counter-sunk boring which accepts the upper two-thirds of the glide. Legs attach to tabletops by means of a 5" square x 5/16" thick steel plate. The plate is attached to the leg by a 5/16" x 2-1/2" machine bolt engaging a 5/8" diameter barrel nut inserted into the leg. The steel plate is attached to the tabletop by five 5/16" x 1" machine bolts engaging internally and externally threaded bushings in the underside of the tabletop.

CASTER (FOR WOOD LEG)

When specified, a 3" black nylon hooded twin-wheel caster with a brake is supplied. Add one caster per table leg (sold each).

LEGS (METAL)

Legs will be 2-3/8" round steel tubing with a wall thickness not less than .64". Legs are supplied with a standard glide insert. Lockable caster inserts interchange with the glide insert on any leg. Table legs will be attached to the tabletop by means of a flange welded to the leg tube. The attachment flange will be 4-5/8" in diameter formed and welded on two sides. The leg flange is attached to the tabletop by six (6) 1/4"-20 x 1" bolts engaging 1/4" internal and external threaded bushings embedded in the underside of the tabletop. Legs will be finished with electrostatic applied epoxy powder-coat paint.

CASTER (FOR METAL LEG)

When specified, a 2-1/4" black nylon hooded twin-wheel caster with a brake is supplied. Lockable caster inserts interchange with the glide insert on any leg. Add one caster per table leg (sold each).

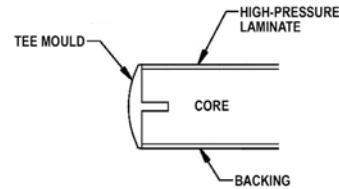

Edge Detail

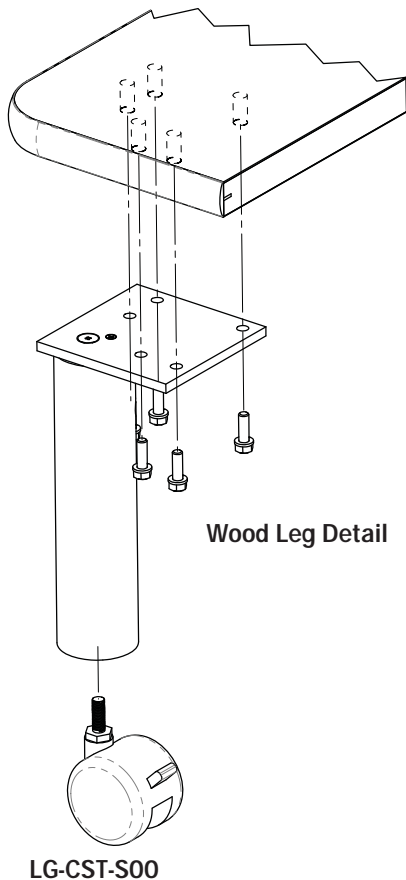

Wood Leg Detail

LG-CST-S00

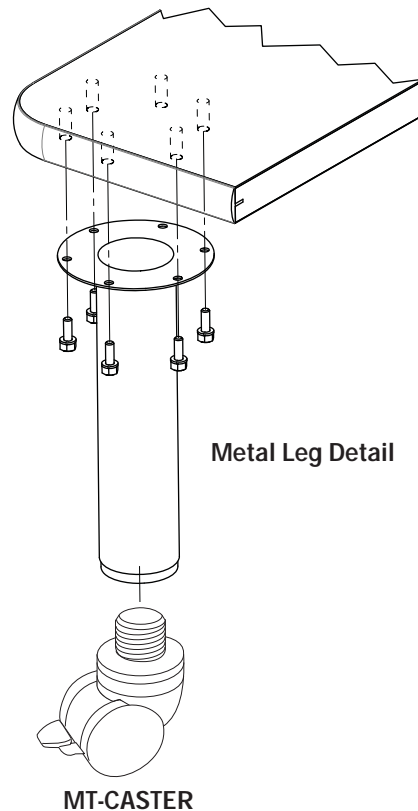





Metal Leg Detail

MT-CASTER

Mobile Tables

Mobile Tables

Note: Tables come equipped with two lockable casters, additional casters (below) can be ordered for other legs.

Oak Wood Leg Catalog No.	Metal Leg Catalog No.	Description	H x W x D	Wt. (lbs.)	Oak Wood Leg Price	Metal Leg Price	
60-768-W00	60-768-M00	Adult Table	29" x 55-1/4" x 50"	110	\$884	\$884	
60-Y68-W00	60-Y68-M00	Youth Table	27-1/2" x 55-1/4" x 50"	110	\$884	\$884	
60-J68-W00	60-J68-M00	Juvenile Table	25" x 55-1/4" x 50"	110	\$884	\$884	
60-799-W00	60-799-M00	Adult Table	29" x 45" x 36"	105	\$981	\$981	
60-Y99-W00	60-Y99-M00	Youth Table	27-1/2" x 45" x 36"	105	\$981	\$981	
60-J99-W00	60-J99-M00	Juvenile Table	25" x 45" x 36"	105	\$981	\$981	
60-763-W00	60-763-M00	Adult Table	29" x 45" x 39-3/4"	110	\$872	\$872	
60-Y63-W00	60-Y63-M00	Youth Table	27-1/2" x 45" x 39-3/4"	110	\$872	\$872	
60-J63-W00	60-J63-M00	Juvenile Table	25" x 45" x 39-3/4"	110	\$872	\$872	
60-778-W00	60-778-M00	Adult Table	29" x 53-5/8" x 51-3/8"	105	\$1,302	\$1,302	
60-Y78-W00	60-Y78-M00	Youth Table	27-1/2" x 53-5/8" x 51-3/8"	105	\$1,302	\$1,302	
60-J78-W00	60-J78-M00	Juvenile Table	25" x 53-5/8" x 51-3/8"	105	\$1,302	\$1,302	

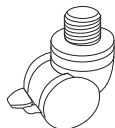
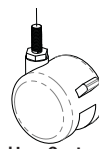
Catalog No.	Description	Price	
MT-CASTER	Caster for Metal Leg 2-1/4" black nylon hooded twin-wheel caster with a brake. Add one caster per table leg (sold each).	\$28	 
LG-CST-S00	Caster for Wood Leg 3" black nylon hooded twin-wheel caster with a brake. Add one caster per table leg (sold each).	\$84	

Please specify Laminate Color (Tables 2 and 4), T-Mold Color (Table 4), Leg Type (Oak or Metal) and Wood Leg Finish (Table 1) or Metal Leg Color (Table 3). Details can be found on pages GEN 4 and GEN 5.

Note: T-Mold Color does NOT have to match Laminate Color.

Mobile Tables

Mobile Tables

Note: Tables come equipped with two lockable casters, additional casters (below) can be ordered for other legs.

	Oak Wood Leg Catalog No.	Metal Leg Catalog No.	Description	H x W x D	Wt. (lbs.)	Oak Wood Leg Price	Metal Leg Price
	60-780-W00	60-780-M00	Adult Table	29" x 68-3/4" x 52-1/2"	100	\$1,101	\$1,101
	60-Y80-W00	60-Y80-M00	Youth Table	27-1/2" x 68-3/4" x 52-1/2"	100	\$1,101	\$1,101
	60-J80-W00	60-J80-M00	Juvenile Table	25" x 68-3/4" x 52-1/2"	100	\$1,101	\$1,101

	Oak Wood Leg Catalog No.	Metal Leg Catalog No.	Description	H x W x D	Wt. (lbs.)	Oak Wood Leg Price	Metal Leg Price
	60-774-W00	60-774-M00	Adult Table	29" x 75-1/2" x 64-7/8"	140	\$1,373	\$1,373
	60-Y74-W00	60-Y74-M00	Youth Table	27-1/2" x 75-1/2" x 64-7/8"	140	\$1,373	\$1,373
	60-J74-W00	60-J74-M00	Juvenile Table	25" x 75-1/2" x 64-7/8"	140	\$1,373	\$1,373

	Oak Wood Leg Catalog No.	Metal Leg Catalog No.	Description	H x W x D	Wt. (lbs.)	Oak Wood Leg Price	Metal Leg Price
	60-776-W00	60-776-M00	Adult Table	29" x 85-1/2" x 53"	125	\$1,373	\$1,373
	60-Y76-W00	60-Y76-M00	Youth Table	27-1/2" x 85-1/2" x 53"	125	\$1,373	\$1,373
	60-J76-W00	60-J76-M00	Juvenile Table	25" x 85-1/2" x 53"	125	\$1,373	\$1,373

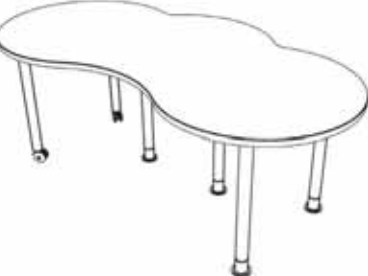
	Oak Wood Leg Catalog No.	Metal Leg Catalog No.	Description	H x W x D	Wt. (lbs.)	Oak Wood Leg Price	Metal Leg Price
	60-781-W00	60-781-M00	Adult Table	29" x 78-1/2" x 41"	120	\$1,523	\$1,523
	60-Y81-W00	60-Y81-M00	Youth Table	27-1/2" x 78-1/2" x 41"	120	\$1,523	\$1,523
	60-J81-W00	60-J81-M00	Juvenile Table	25" x 78-1/2" x 41"	120	\$1,523	\$1,523

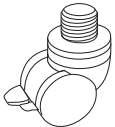
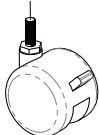
	Catalog No.	Description	Price
 	MT-CASTER	Caster for Metal Leg 2-1/4" black nylon hooded twin-wheel caster with a brake. Add one caster per table leg (sold each).	\$28
	LG-CST-S00	Caster for Wood Leg 3" black nylon hooded twin-wheel caster with a brake. Add one caster per table leg (sold each).	\$84
		Metal Leg Caster	
		Wood Leg Caster	

Please specify Laminate Color (Tables 2 and 4), T-Mold Color (Table 4), Leg Type (Oak or Metal) and Wood Leg Finish (Table 1) or Metal Leg Color (Table 3). Details can be found on pages GEN 4 and GEN 5.

Note: T-Mold Color does NOT have to match Laminate Color.

Sync Tables



2017 Price List and Specifications

Brodart Co. Contract Furniture - Made in USA

280 North Road, Clinton County Industrial Park • McElhattan, PA 17748

Toll-Free: 888-521-1884 • E-Mail: furniture@brodart.com • www.brodartfurniture.com

General Specifications

TABLETOP

Tabletop will be 1-3/16" thick, 3-ply 45# density particleboard, with .050" thick high-pressure laminate surface and .020" thick backing sheet for balanced construction. Edges will be flexible polyethylene tee mold, 5/16" thick x 1-1/4" wide. Core material receives a 5/64" x 3/8" route to receive tee mold. Tee mold is applied to core material after the laminate and backer sheet.

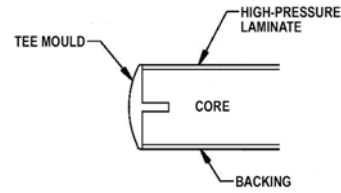

Edge Detail

LEGS (METAL)

Legs will be 2-3/8" round steel tubing with a wall thickness not less than .64". Legs are supplied with a standard glide insert. Lockable caster inserts interchange with the glide insert on any leg. Table legs will be attached to the tabletop by means of a flange welded to the leg tube. The attachment flange will be 4-5/8" in diameter formed and welded on two sides. The leg flange is attached to the tabletop by six (6) 1/4"-20 x 1" bolts engaging 1/4" internal and external threaded bushings embedded in the underside of the tabletop. Legs will be finished with electrostatic applied epoxy powder-coat paint.

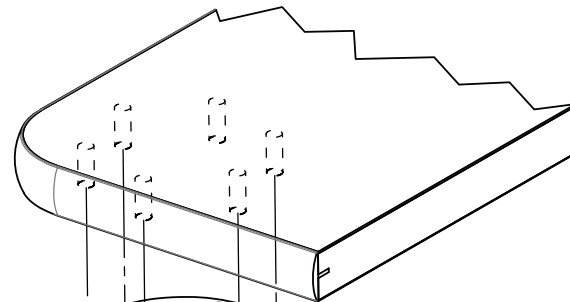

Leg Detail

CASTER

When specified, a 2-1/4" black nylon hooded twin-wheel caster with a brake is supplied. Lockable caster inserts interchange with the glide insert on any leg. Add one caster per table leg (sold each).

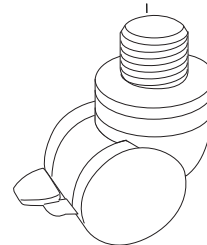



MTCASTER

Collaborative Tables

Sync Tables

Note: Tables come equipped with two lockable casters, additional casters (below) can be ordered for other legs.

Catalog No.	Description	H x W x D	Wt. (lbs.)	Price	
MST45HG29ARMMS	Adult Table	29" x 45" x 36"	90	\$905	Hourglass Table 
MST45HG27ARMMS	Youth Table	27-1/2" x 45" x 36"	90	\$905	
MST45HG25ARMMS	Juvenile Table	25" x 45" x 36"	90	\$905	
MST53HG29ARMMS	Adult Table	29" x 53" x 43"	100	\$1,120	
MST53HG27ARMMS	Youth Table	27-1/2" x 53" x 43"	100	\$1,120	
MST53HG25ARMMS	Juvenile Table	25" x 53" x 43"	100	\$1,120	

MST48RD29ARMMS	Adult Table	29" x 48" x 48"	90	\$905	Round Table 
MST48RD27ARMMS	Youth Table	27-1/2" x 48" x 48"	90	\$905	
MST48RD25ARMMS	Juvenile Table	25" x 48" x 48"	90	\$905	

MST48DT29ARMMS	Adult Table	29" x 48" x 24"	80	\$905	Docking Table 
MST48DT27ARMMS	Youth Table	27-1/2" x 48" x 24"	80	\$905	
MST48DT25ARMMS	Juvenile Table	25" x 48" x 24"	80	\$905	

MST60SC29ARMMS	Adult Table	29" x 60" x 31-5/8"	100	\$882	Semi-Circle Table 
MST60SC27ARMMS	Youth Table	27-1/2" x 60" x 31-5/8"	100	\$882	
MST60SC25ARMMS	Juvenile Table	25" x 60" x 31-5/8"	100	\$882	

MST64TR29ARMMS	Adult Table	29" x 64" x 38"	90	\$1,068	Trapezoid Table 
MST64TR27ARMMS	Youth Table	27-1/2" x 64" x 38"	90	\$1,068	
MST64TR25ARMMS	Juvenile Table	25" x 64" x 38"	90	\$1,068	

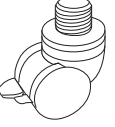
Catalog No.	Description	Price	
MT-CASTER	Metal Leg Caster 2-1/4" black nylon hooded twin-wheel caster with a brake. Add one caster per table leg (sold each).	\$28	Casters 

Please specify Laminate Color (Tables 2 and 4), T-Mold Color (Table 4) and Metal Leg Color (Table 3). Details can be found on pages GEN 4 and GEN 5.

Note: T-Mold Color does NOT have to match Laminate Color.

Note: Tables come equipped with two lockable casters, additional casters (below) can be ordered for other legs.

	Catalog No.	Description	H x W x D	Wt. (lbs.)	Price
	MST65FT29ARMMS	Adult Table	29" x 65" x 37-3/4"	100	\$1,027
	MST65FT27ARMMS	Youth Table	27-1/2" x 65" x 37-3/4"	100	\$1,027
	MST65FT25ARMMS	Juvenile Table	25" x 65" x 37-3/4"	100	\$1,027

	60793M00	Adult Table	29" x 46-7/32" x 44-5/8"	90	\$1,149
	60Y93M00	Youth Table	27-1/2" x 46-7/32" x 44-5/8"	90	\$1,149
	60J93M00	Juvenile Table	25" x 46-7/32" x 44-5/8"	90	\$1,149

	60794M00	Adult Table	29" x 54-19/32" x 51-13/32"	90	\$1,209
	60Y94M00	Youth Table	27-1/2" x 54-19/32" x 51-13/32"	90	\$1,209
	60J94M00	Juvenile Table	25" x 54-19/32" x 51-13/32"	90	\$1,209

	60795M00	Adult Table	29" x 54-1/4" x 23-3/4"	80	\$918
	60Y95M00	Youth Table	27-1/2" x 54-1/4" x 23-3/4"	80	\$918
	60J95M00	Juvenile Table	25" x 54-1/4" x 23-3/4"	80	\$918

	Catalog No.	Description	Price
	MT-CASTER	Metal Leg Caster 2-1/4" black nylon hooded twin-wheel caster with a brake. Add one caster per table leg (sold each).	\$28

Please specify Laminate Color (Tables 2 and 4), T-Mold Color (Table 4) and Metal Leg Color (Table 3). Details can be found on pages GEN 4 and GEN 5.

Note: T-Mold Color does NOT have to match Laminate Color.

Collection Accessories



2017 Price List and Specifications

Brodart Co. Contract Furniture - Made in USA

280 North Road, Clinton County Industrial Park • McElhattan, PA 17748

Toll-Free: 888-521-1884 • E-Mail: furniture@brodart.com • www.brodartfurniture.com

XX-193-S00
39"H Double Action Gate

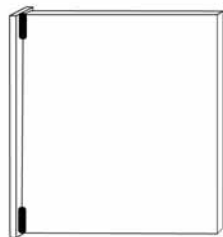

XX-E93-S00
32"H Double Action Gate

XX-342-S00
Mobile
Printer Stand

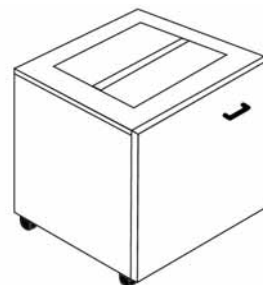

XX-914-S00
Depressible Receiving
Truck for 32"H Units



XX-915-S00
Depressible Receiving
Truck for 39"H Units



XX-914-S02
Depressible Receiving
Truck for 32"H Units
w/Rubber Bumpers

XX-915-S02
Depressible Receiving
Truck for 39"H Units
w/Rubber Bumpers

Catalog No.	Description	Wt. (lbs.)	Price
Accessories In Oak Wood			
TO-193-S00	39"H Double Action Gate	42	\$1,107
TO-E93-S00	32"H Double Action Gate	40	\$988
TO-342-S00	Mobile Printer Stand	50	\$1,759
TO-914-S00	Depressible Receiving Truck for 32"H Units	100	\$1,557
TO-914-S02	Depressible Receiving Truck for 32"H Units w/Rubber Bumpers	100	\$1,695
TO-915-S00	Depressible Receiving Truck for 39"H Units	100	\$1,812
TO-915-S02	Depressible Receiving Truck for 39"H Units w/Rubber Bumpers	100	\$1,957
TO-025-S00	Knee Space Hang A Drawer without Lock (No image)	18	\$337
TO-025-S02	Knee Space Hang A Drawer with Lock (No image)	18	\$379
Accessories In Maple Wood			
MO-193-S00	39"H Double Action Gate	42	\$1,206
MO-E93-S00	32"H Double Action Gate	40	\$1,078
MO-342-S00	Mobile Printer Stand	50	\$1,917
MO-914-S00	Depressible Receiving Truck for 32"H Units	100	\$1,696
MO-914-S02	Depressible Receiving Truck for 32"H Units w/Rubber Bumpers	100	\$1,848
MO-915-S00	Depressible Receiving Truck for 39"H Units	100	\$1,975
MO-915-S02	Depressible Receiving Truck for 39"H Units w/Rubber Bumpers	100	\$2,133
MO-025-S00	Knee Space Hang A Drawer without Lock (No image)	18	\$367
MO-025-S02	Knee Space Hang A Drawer with Lock (No image)	18	\$413
Accessories In Cherry Wood			
CO-193-S00	39"H Double Action Gate	42	\$1,328
CO-E93-S00	32"H Double Action Gate	40	\$1,187
CO-342-S00	Mobile Printer Stand	50	\$2,110
CO-914-S00	Depressible Receiving Truck for 32"H Units	100	\$1,867
CO-914-S02	Depressible Receiving Truck for 32"H Units w/Rubber Bumpers	100	\$2,034
CO-915-S00	Depressible Receiving Truck for 39"H Units	100	\$2,175
CO-915-S02	Depressible Receiving Truck for 39"H Units w/Rubber Bumpers	100	\$2,349
CO-025-S00	Knee Space Hang A Drawer without Lock (No image)	18	\$404
CO-025-S02	Knee Space Hang A Drawer with Lock (No image)	18	\$456

Please specify Wood Finish (Table 1) . Details can be found on page GEN 4.

XX-019-S00
33"H
Open Shelf/
Computer Unit
w/Casters



XX-020-S00
33"H
Cupboard Unit
w/Caster



XX-021-S00
33"H
3 Drawer Unit
w/Caster



XX-E19-S00
25-1/2"H
Open Shelf/
Computer Unit
w/Casters

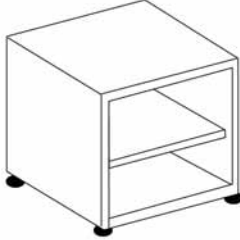

XX-E20-S00
25-1/2"H
Cupboard Unit
w/Caster

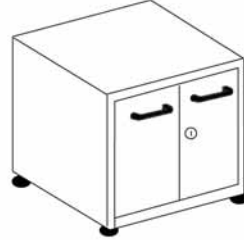

XX-E21-S00
25-1/2"H
2 Drawer Unit
w/Caster

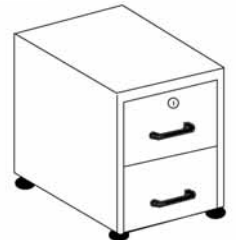

XX-E19-S01
23-1/4"H
Open Shelf/
Computer Unit
w/Glides

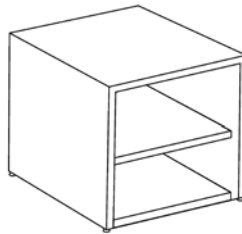

XX-E20-S01
23-1/4"H
Cupboard Unit
w/Glides

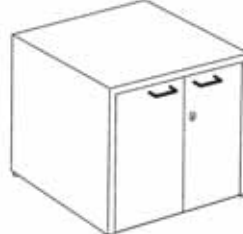

XX-E21-S01
23-1/4"H
2 Drawer Unit
w/Glides

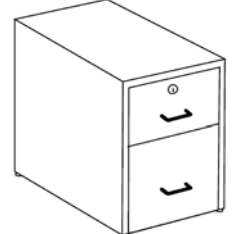

Catalog No.	Description	Wt. (lbs.)	Price
Mobile Pedestals In Oak Wood			
TO-019-S00	33"H Open Shelf/Computer Unit with Casters	115	\$1,395
TO-E19-S00	25-1/2"H Open Shelf/Computer Unit with Casters	100	\$1,246
TO-E19-S01	23-1/4"H Open Shelf/Computer Unit with Nail Glides	100	\$1,246
TO-020-S00	33"H Cupboard Unit with Caster	120	\$2,010
TO-E20-S00	25-1/2"H Cupboard Unit with Caster	105	\$1,818
TO-E20-S01	23-1/4"H Cupboard Unit with Nail Glides	105	\$1,818
TO-021-S00	33"H 3 Drawer Unit with Caster	170	\$1,790
TO-E21-S00	25-1/2"H 2 Drawer Unit with Casters	150	\$1,608
TO-E21-S01	25-1/2"H 2 Drawer Unit with Nail Glides	150	\$1,608

Mobile Pedestals In Maple Wood			
MO-019-S00	33"H Open Shelf/Computer Unit with Casters	115	\$1,522
MO-E19-S00	25-1/2"H Open Shelf/Computer Unit with Casters	100	\$1,358
MO-E19-S01	23-1/4"H Open Shelf/Computer Unit with Nail Glides	100	\$1,358
MO-020-S00	33"H Cupboard Unit with Caster	120	\$2,190
MO-E20-S00	25-1/2"H Cupboard Unit with Caster	105	\$1,982
MO-E20-S01	23-1/4"H Cupboard Unit with Nail Glides	105	\$1,982
MO-021-S00	33"H 3 Drawer Unit with Caster	170	\$1,952
MO-E21-S00	25-1/2"H 2 Drawer Unit with Casters	150	\$1,753
MO-E21-S01	25-1/2"H 2 Drawer Unit with Nail Glides	150	\$1,753

Mobile Pedestals In Cherry Wood			
CO-019-S00	33"H Open Shelf/Computer Unit with Casters	115	\$1,675
CO-E19-S00	25-1/2"H Open Shelf/Computer Unit with Casters	100	\$1,495
CO-E19-S01	23-1/4"H Open Shelf/Computer Unit with Nail Glides	100	\$1,495
CO-020-S00	33"H Cupboard Unit with Caster	120	\$2,411
CO-E20-S00	25-1/2"H Cupboard Unit with Caster	105	\$2,181
CO-E20-S01	23-1/4"H Cupboard Unit with Nail Glides	105	\$2,181
CO-021-S00	33"H 3 Drawer Unit with Caster	170	\$2,148
CO-E21-S00	25-1/2"H 2 Drawer Unit with Casters	150	\$1,931
CO-E21-S01	25-1/2"H 2 Drawer Unit with Nail Glides	150	\$1,931

Please specify Wood Finish (Table 1) . Details can be found on page GEN 4.

Basic Keyboard Pullout

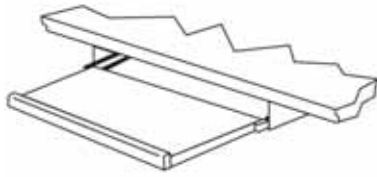

Articulating Keyboard Pullout with Swing A Mouse

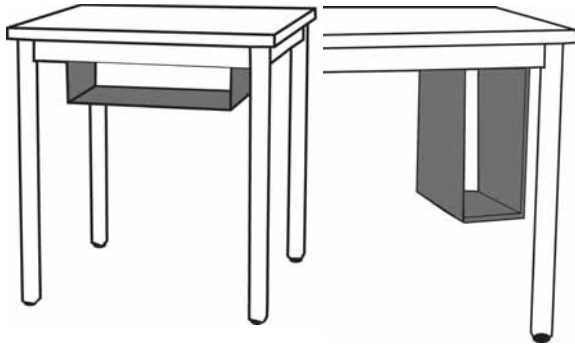
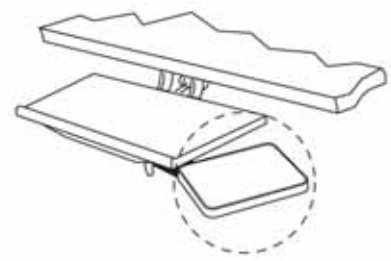

Metal Adjustable CPU Holder

Catalog No.	Description	Wt. (lbs.)	Price
Computer Accessories			
60-464-000	Basic Keyboard Pullout, Black	15	\$187
60-465-000	Articulating Keyboard Pullout, Black	13	\$455
60-465-002	Swing A Mouse, Black	2	\$166
73-105-S00	Metal Adjustable CPU Holder	7	\$331

Oak Catalog No.	Maple Catalog No.	Description	H x W x D	Wt. (lbs.)	Oak Price	Maple Price
-----------------	-------------------	-------------	-----------	------------	-----------	-------------

Movable Printer Shelf for PAC Stations

64-694-S00 OAK	64-694-S00 MAP	Printer Shelf	3" x 14-1/4" x 23-1/4"	10	\$510	\$556
Shelf mounts on top edge of vertical panels. Shelf does not attach to panels. It may be completely removed or relocated at any time. Usable shelf size is 13"W x 22"D.						

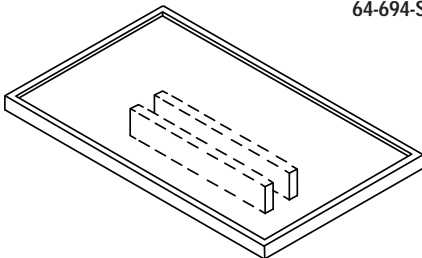

Please specify Wood Finish (Table 1) . Details can be found on page GEN 4.

Classic Shelving



2017 Price List and Specifications

Brodart Co. Contract Furniture - Made in USA

280 North Road, Clinton County Industrial Park • McElhattan, PA 17748

Toll-Free: 888-521-1884 • E-Mail: furniture@brodart.com • www.brodartfurniture.com

General Specifications

CONSTRUCTION

Shelving construction is modular type, utilizing all natural hardwoods. No particleboard or synthetic materials will be used. Shelving units are designed with the starter and adder concept and measure 36-3/16" from center to center of the uprights. Oak and Maple are the standard wood species for Brodart shelving.

END PANELS

End panels are 1" thick, 9-ply Formaldehyde-free hardwood veneer core plywood. All exposed vertical and top edges are banded with matching solid Northern-grown Oak or Maple hardwood. Edges are square, but eased. Vertical rows of holes are drilled near the front and rear of each panel for shelf adjustment on 32mm centers. Panels are drilled at front, rear, top, and bottom for embedding internal and external threaded bushings. Tops and bases are attached to end panels with 5/16" - 18 x 2" hex-head bolts and washers. Lag bolts or wood screws are not used. Clip and metal strip style shelf attachments are available if specified.

INTERMEDIATE UPRIGHTS

Intermediate uprights are 1" thick, 9-ply Formaldehyde-free hardwood veneer core plywood. All exposed vertical and top edges are banded with matching solid Northern-grown Oak or Maple hardwood. Edges are square, but eased. Shelf pinholes are bored on both sides of the panel but staggered so that pins can be deeply seated. Panels are drilled through at front, rear, top, and bottom for attachment of tops and bases with 5/16" - 18 x 4-1/2" hex-head bolts, nuts, and washers. Clip and metal strip style shelf attachments are available if specified.

BASE

The base front is 4"H X 3/4" thick solid Northern-grown Oak or Maple hardwood. A 2" x 3/4" rail is tenoned full-length to the inside of the front. Bolting cleats 1-1/4" x 1-1/4" are glued and stapled perpendicular at the ends of the rail and drilled to allow assembly bolts to pass through. A second full-length rail is glued and stapled to the rear of the bolting cleats for support and proper alignment. Bases are manufactured so the base shelf rests on the bolting cleats set behind and flush with the top of the base front.

ATTACHMENT

Four bolts are used to attach each single-faced base or top, except for 16"D single-faced units, on which six bolts are used. Eight bolts are used to attach each double-faced base or top, except for 32"D double-faced units, on which twelve bolts are used. All hardware is concealed from view after assembly. Each single-faced unit is supplied with a metal bracket, lead anchor, and screws for fastening to the wall. Double-faced ranges that do not have partitions receive two steel sway bars per range, 46-7/8" long and 5/16" square. These attach to the starter panel at both sides of the range and the adjoining intermediate panel with screws.

BACKS AND PARTITIONS

Backs and partitions are constructed of 3-ply or 5-ply furniture-grade Oak or Maple veneered plywood finished to match shelving. Backs are finished on one side and used with single-faced shelving. Partitions are used with double-faced shelving, and therefore finished on both sides. Economical painted backs and partitions are also available upon request.

Note: Backs and partitions do not function with "Book Stop" shelving.

Note: Clip and Strip shelving is available for Wood Shelf units ONLY and can be ordered by changing the S1 prefix on the starter unit to S3, and changing the S2 prefix on the adder unit to S4. i.e.: S3-861-S00 or S4-861-S00.

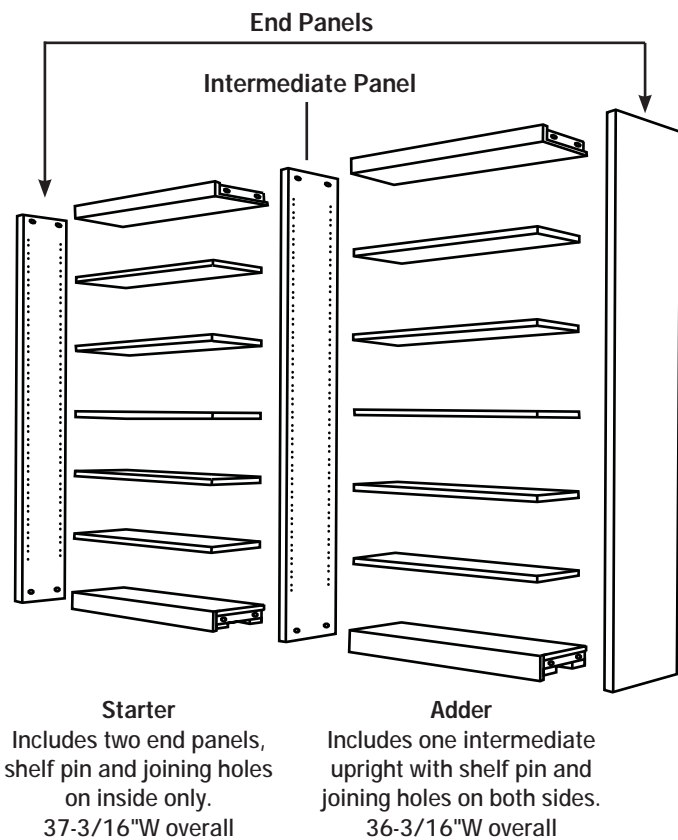

General Specifications - Tops

WOOD SHELVING TOPS

Cornice tops have a 2-1/8" fascia, 3/4" thick, of solid Northern-grown Oak or Maple hardwood banded to a 3/4" 7-ply hardwood plywood panel of specified depth. The top front corner of the fascia has a 1/8" radius. On the inside surface of the top at each end, butted to the fascia, are solid hardwood bolting cleats 1-1/4" x 1-1/4" that are both glued and stapled. For additional strength, a 4" cleat is added at the intersection of the fascia and top panel. Bolting cleats are drilled to allow assembly bolts to pass through.

Note: Tops on 72"H, 82"H, and 90"H units are inverted.

SUB TOPS FOR CONTINUOUS SHELVING TOPS

Sub tops are constructed using solid hardwood cleats and plywood components. Tops have a 2-1/8" fascia, 3/4" thick, of solid Northern-grown Oak or Maple hardwood banded to the front.

Note: Sub-tops for shelving (to accept continuous HPL Tops - sold separately) are available and can be ordered by changing the S00 extension on the catalog number to S02. i.e.: S1-861-S02.

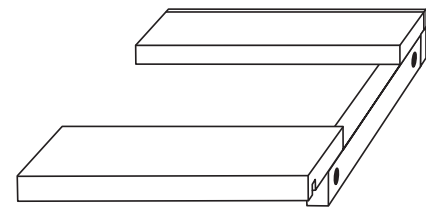

Sub-Top

INDIVIDUAL HIGH-PRESSURE LAMINATE TOPS

Cornice tops have a 2-1/8" fascia, 3/4" thick, of solid Northern-grown Oak or Maple hardwood banded to a 3/4" 3-ply 45# density particleboard panel of specified depth, that consists of a top surface of .050" thick high-pressure laminate, with a backing sheet not less than .020" thick for balanced construction. High-pressure laminate has a lo-glare finish resistant to scratches, fading, and staining that meets or exceeds NEMA standards.

Note: Individual HPL tops for shelving are available and can be ordered by changing the S00 extension on the catalog number to S03. i.e.: S1-861-S03.

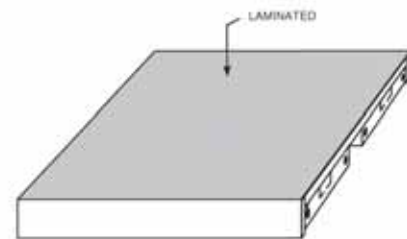

Individual High-Pressure Laminate Top

SHELVING TOPS (High-Pressure Laminate and Continuous)

To order wood shelving with individual high-pressure laminate tops use the standard shelving part number, changing the S00 to S03. Tops are available in 42" and 60-1/2"H units. If 72" or 82" is required, order as M03.

To order wood shelving with sub tops for use with continuous shelving tops, use the standard shelving part number changing the S00 to S02. The sub tops are available in 42", 48", and 60-1/2"H units.

Note: Continuous tops must be ordered separately.



Shelving Starter/Adder with Sub-Top and Continuous Top

General Specifications - Shelves & Mobile Units

WOOD SHELVES

Shelves are 3/4" thick, glued-up solid Northern-grown Oak or Maple hardwood. Random widths no more than 4" or less than 1-1/2" are used. To ensure adequate support for heavy volumes, no substitute for solid hardwood is permitted. Adjustable shelves are grooved 11/32" diameter half round on the underside to set firmly on 1" long, 5/16" diameter threaded shelf pins, cadmium-plated. Shelf depths are nominal.

OMEGA (STEEL) SHELVES

Omega (steel) shelves are designed to fit Brodart's wood shelving units. These shelves are 18-gauge steel stamped with notches in the bottom edge to fit over shelf pins. The front and back edges are triple bent for strength and to eliminate sharp edges. Shelves are electrostatic powder-coat painted with epoxy paint and oven cured. Shelf accepts spring-type overhead wire book support. Units are supplied with a wood base shelf. Omega shelves are available in many standard and optional colors - please call for selection.

OMEGA "BOOK STOP" STEEL SHELVES

Omega "Book Stop" steel shelves are designed to fit Brodart's wood shelving units. These shelves are 18-gauge steel stamped with notches in the bottom edge to fit over shelf pins. The front and back edges are triple bent for strength and to eliminate sharp edges. **The back edge of the shelf is bent upward to form a 90° angle,** 1-5/8"H above the shelf surface to function as a book stop. Shelves are electrostatic powder-coat painted with epoxy paint and oven cured. Units are supplied with a metal base shelf. Omega shelves are available in many standard and optional colors - please call for selection.

Note: Backs and partitions do not function with "Book Stop" shelving.

MOBILE SHELVING UNITS

Mobile Shelving is available on 42", 48", and 60-1/2" units. Shelving construction is the same as the standard shelving with the exception of the base. The base facing is 4-3/8"H, receives four reinforced 14-gauge corner brackets with four 2-1/2" heavy-duty swivel casters attached to a 14-gauge caster bracket. Corner brackets are attached to the end panel and the base facing. The caster assembly is hidden within the base, giving the appearance of standard unit. All mobile units receive partitions, with the exception of Omega Book Stop units, which receive sway braces. Units are offered as starter or starter/adder only.

PICTURE BOOK SHELVING SHELVES

Picture Book Shelving is 12"D with six (6) hardboard dividers per shelf. A 2"H, solid wood back keeps dividers in place.

GLASS DOOR SHELVING

Each unit has sliding 1/4" thick laminated glass doors to protect shelved items. A solid back and door lock ensures safe storage. Door pulls are provided. Doors slide smoothly in aluminum tracks at top and bottom. Wood shelves are 9"D.

TILT AND STORE SHELVING

Sloping display shelves have a 13"H clear display area and lift up to expose flat storage shelves via a pivot hinge. Storage space is concealed when display shelves are in normal position.

METAL PICTURE BOOK SHELVING

Metal Picture Book Shelves are 11"D x 7"H overall with two metal dividers per shelf. Dividers can be placed at 26 equal spaces along the width of each shelf. A steel cotter pin is provided with each divider to prevent removal.

PERIODICAL SHELVING

Periodical shelving can display any type of media such as CD's, videocassettes, books and magazines. The shelf can be divided with the six dividers provided with each shelf. Each sloping display shelf will have a 13-3/4"H clear display area.



Flat Wood Shelf

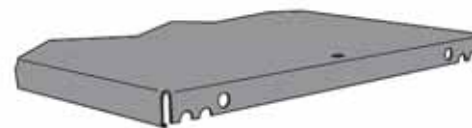

Omega Flat Shelf

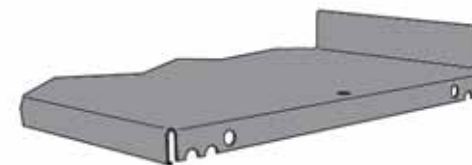

Omega Book Stop Shelf

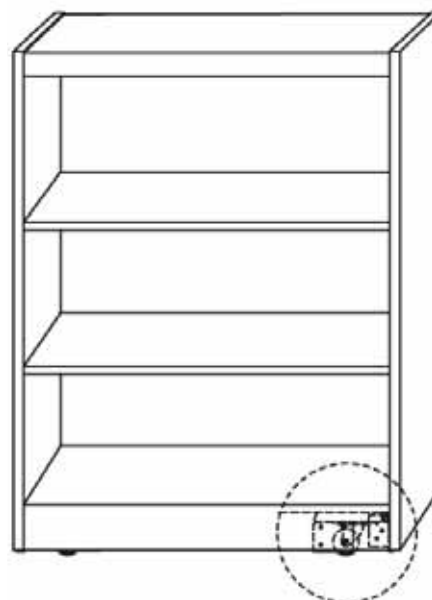

Mobile Shelving Unit

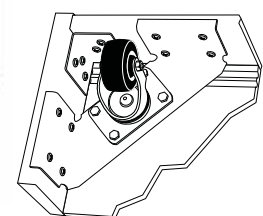

Oak Catalog No.	Maple Catalog No.	Description	H x W x D	Wt. (lbs.)	Oak Price	Maple Price
5 Adjustable Shelves, 1 Fixed Shelf and 1 Base Shelf						
S1-960-S00	1S-960-S00	S/F Starter	90" x 37-3/16" x 10"	103	\$1,462	\$1,535
S2-960-S00	2S-960-S00	S/F Adder	90" x 36-3/16" x 10"	90	\$1,113	\$1,169
S1-967-S00	1S-967-S00	S/F Starter	90" x 37-3/16" x 12"	122	\$1,577	\$1,656
S2-967-S00	2S-967-S00	S/F Adder	90" x 36-3/16" x 12"	102	\$1,199	\$1,259
S1-673-S00	1S-673-S00	S/F Starter	90" x 37-3/16" x 16"	127	\$1,755	\$1,843
S2-673-S00	2S-673-S00	S/F Adder	90" x 36-3/16" x 16"	107	\$1,376	\$1,445



90"H Wood Shelves



4 Adjustable Shelves, 1 Fixed Shelf and 1 Base Shelf						
S1-976-S00	1S-976-S00	S/F Starter	82" x 37-3/16" x 10"	93	\$1,333	\$1,401
S2-976-S00	2S-976-S00	S/F Adder	82" x 36-3/16" x 10"	80	\$1,011	\$1,061
S1-977-S00	1S-977-S00	S/F Starter	82" x 37-3/16" x 12"	112	\$1,440	\$1,513
S2-977-S00	2S-977-S00	S/F Adder	82" x 36-3/16" x 12"	92	\$1,092	\$1,147
S1-679-S00	1S-679-S00	S/F Starter	82" x 37-3/16" x 16"	117	\$1,602	\$1,682
S2-679-S00	2S-679-S00	S/F Adder	82" x 36-3/16" x 16"	97	\$1,254	\$1,317

82"H Wood Shelves



4 Adjustable Shelves and 1 Base Shelf						
S1-861-S00	1S-861-S00	S/F Starter	72" x 37-3/16" x 10"	88	\$1,215	\$1,276
S2-861-S00	2S-861-S00	S/F Adder	72" x 36-3/16" x 10"	75	\$919	\$965
S1-863-S00	1S-863-S00	S/F Starter	72" x 37-3/16" x 12"	102	\$1,316	\$1,382
S2-863-S00	2S-863-S00	S/F Adder	72" x 36-3/16" x 12"	87	\$994	\$1,044
S1-675-S00	1S-675-S00	S/F Starter	72" x 37-3/16" x 16"	107	\$1,439	\$1,511
S2-675-S00	2S-675-S00	S/F Adder	72" x 36-3/16" x 16"	92	\$1,139	\$1,196

72"H Wood Shelves



4 Adjustable Shelves and 1 Base Shelf						
S1-979-S00	1S-979-S00	S/F Starter	60-1/2" x 37-3/16" x 10"	75	\$1,098	\$1,153
S2-979-S00	2S-979-S00	S/F Adder	60-1/2" x 36-3/16" x 10"	65	\$829	\$871
S1-988-S00	1S-988-S00	S/F Starter	60-1/2" x 37-3/16" x 12"	96	\$1,189	\$1,249
S2-988-S00	2S-988-S00	S/F Adder	60-1/2" x 36-3/16" x 12"	81	\$899	\$945
S1-678-S00	1S-678-S00	S/F Starter	60-1/2" x 37-3/16" x 16"	101	\$1,307	\$1,372
S2-678-S00	2S-678-S00	S/F Adder	60-1/2" x 36-3/16" x 16"	86	\$1,023	\$1,074

60-1/2"H Wood Shelves



Please specify Wood Finish (Table 1). Details can be found on page GEN 4.

For details regarding Clip & Strip Shelving, Sub Tops or Individual HPL Tops, please reference the Modifications & Up Charges Section located on page MOD 8.

Note: Shelving Backs and Partitions are sold separately and are located in the Shelving Accessories Section on pages CLA 40 and CLA 41.



48"H Wood Shelves



Oak Catalog No.	Maple Catalog No.	Description	H x W x D	Wt. (lbs.)	Oak Price	Maple Price
<i>2 Adjustable Shelves and 1 Base Shelf</i>						
S1-761-S00	1S-761-S00	S/F Starter	48" x 37-3/16" x 10"	71	\$907	\$952
S2-761-S00	2S-761-S00	S/F Adder	48" x 36-3/16" x 10"	63	\$656	\$689
S1-762-S00	1S-762-S00	S/F Starter	48" x 37-3/16" x 12"	84	\$967	\$1,016
S2-762-S00	2S-762-S00	S/F Adder	48" x 36-3/16" x 12"	74	\$693	\$728
S1-676-S00	1S-676-S00	S/F Starter	48" x 37-3/16" x 16"	89	\$1,048	\$1,100
S2-676-S00	2S-676-S00	S/F Adder	48" x 36-3/16" x 16"	79	\$771	\$809

42"H Wood Shelves

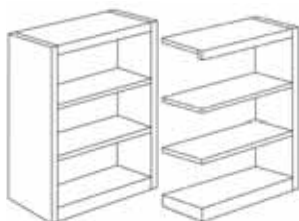

Oak Catalog No.	Maple Catalog No.	Description	H x W x D	Wt. (lbs.)	Oak Price	Maple Price
<i>2 Adjustable Shelves and 1 Base Shelf</i>						
S1-981-S00	1S-981-S00	S/F Starter	42" x 37-3/16" x 10"	61	\$857	\$901
S2-981-S00	2S-981-S00	S/F Adder	42" x 36-3/16" x 10"	53	\$612	\$643
S1-989-S00	1S-989-S00	S/F Starter	42" x 37-3/16" x 12"	74	\$913	\$958
S2-989-S00	2S-989-S00	S/F Adder	42" x 36-3/16" x 12"	64	\$643	\$675
S1-677-S00	1S-677-S00	S/F Starter	42" x 37-3/16" x 16"	79	\$946	\$994
S2-677-S00	2S-677-S00	S/F Adder	42" x 36-3/16" x 16"	68	\$672	\$705

Please specify Wood Finish (Table 1). Details can be found on page GEN 4.

For details regarding Clip & Strip Shelving, Sub Tops or Individual HPL Tops, please reference the Modifications & Up Charges Section located on page MOD 8.

Note: Shelving Backs and Partitions are sold separately and are located in the Shelving Accessories Section on pages CLA 40 and CLA 41.

Oak Catalog No.	Maple Catalog No.	Description	H x W x D	Wt. (lbs.)	Oak Price	Maple Price
5 Adjustable Shelves, 1 Fixed Shelf and 1 Base Shelf per Side						
S1-969-S00	1S-969-S00	D/F Starter	90" x 37-3/16" x 20"	185	\$2,561	\$2,689
S2-969-S00	2S-969-S00	D/F Adder	90" x 36-3/16" x 20"	153	\$2,023	\$2,124
S1-973-S00	1S-973-S00	D/F Starter	90" x 37-3/16" x 24"	224	\$2,771	\$2,909
S2-973-S00	2S-973-S00	D/F Adder	90" x 36-3/16" x 24"	188	\$2,153	\$2,260
S1-683-S00	1S-683-S00	D/F Starter	90" x 37-3/16" x 32"	239	\$3,079	\$3,233
S2-683-S00	2S-683-S00	D/F Adder	90" x 36-3/16" x 32"	203	\$2,470	\$2,594



90"H Wood Shelves

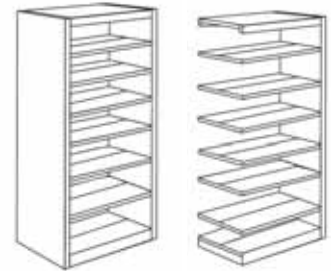

4 Adjustable Shelves, 1 Fixed Shelf and 1 Base Shelf per Side						
S1-983-S00	1S-983-S00	D/F Starter	82" x 37-3/16" x 20"	175	\$2,393	\$2,513
S2-983-S00	2S-983-S00	D/F Adder	82" x 36-3/16" x 20"	143	\$1,863	\$1,956
S1-990-S00	1S-990-S00	D/F Starter	82" x 37-3/16" x 24"	214	\$2,609	\$2,740
S2-990-S00	2S-990-S00	D/F Adder	82" x 36-3/16" x 24"	178	\$2,007	\$2,107
S1-689-S00	1S-689-S00	D/F Starter	82" x 37-3/16" x 32"	229	\$2,899	\$3,045
S2-689-S00	2S-689-S00	D/F Adder	82" x 36-3/16" x 32"	193	\$2,304	\$2,419

82"H Wood Shelves

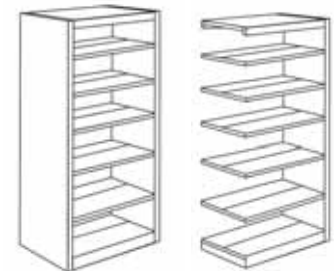

4 Adjustable Shelves and 1 Base Shelf per Side						
S1-865-S00	1S-865-S00	D/F Starter	72" x 37-3/16" x 20"	160	\$2,274	\$1,747
S2-865-S00	2S-865-S00	D/F Adder	72" x 36-3/16" x 20"	128	\$2,388	\$1,834
S1-866-S00	1S-866-S00	D/F Starter	72" x 37-3/16" x 24"	199	\$2,453	\$2,576
S2-866-S00	2S-866-S00	D/F Adder	72" x 36-3/16" x 24"	163	\$1,891	\$1,985
S1-685-S00	1S-685-S00	D/F Starter	72" x 37-3/16" x 32"	214	\$2,602	\$2,732
S2-685-S00	2S-685-S00	D/F Adder	72" x 36-3/16" x 32"	178	\$2,167	\$2,275

72"H Wood Shelves

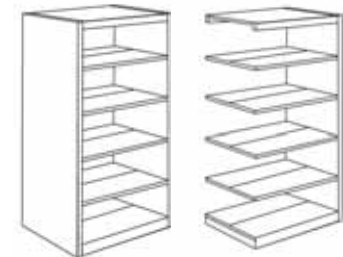

4 Adjustable Shelves and 1 Base Shelf per Side						
S1-985-S00	1S-985-S00	D/F Starter	60-1/2" x 37-3/16" x 20"	139	\$2,154	\$2,261
S2-985-S00	2S-985-S00	D/F Adder	60-1/2" x 36-3/16" x 20"	115	\$1,633	\$1,715
S1-986-S00	1S-986-S00	D/F Starter	60-1/2" x 37-3/16" x 24"	170	\$2,293	\$2,407
S2-986-S00	2S-986-S00	D/F Adder	60-1/2" x 36-3/16" x 24"	142	\$1,779	\$1,868
S1-688-S00	1S-688-S00	D/F Starter	60-1/2" x 37-3/16" x 32"	185	\$2,524	\$2,650
S2-688-S00	2S-688-S00	D/F Adder	60-1/2" x 36-3/16" x 32"	157	\$2,023	\$2,124

60-1/2"H Wood Shelves



Please specify Wood Finish (Table 1). Details can be found on page GEN 4.

For details regarding Clip & Strip Shelving, Sub Tops or Individual HPL Tops, please reference the Modifications & Up Charges Section located on page MOD 8.

Note: Shelving Backs and Partitions are sold separately and are located in the Shelving Accessories Section on pages CLA 40 and CLA 41.



Oak Catalog No.	Maple Catalog No.	Description	H x W x D	Wt. (lbs.)	Oak Price	Maple Price
-----------------	-------------------	-------------	-----------	------------	-----------	-------------

48"H Wood Shelves

2 Adjustable Shelves and 1 Base Shelf per Side

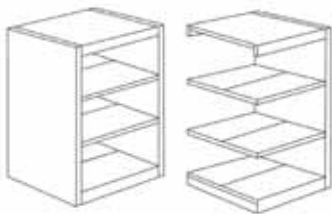

S1-765-S00	1S-765-S00	D/F Starter	48" x 37-3/16" x 20"	111	\$1,642	\$1,724
S2-765-S00	2S-765-S00	D/F Adder	48" x 36-3/16" x 20"	96	\$1,232	\$1,294
S1-766-S00	1S-766-S00	D/F Starter	48" x 37-3/16" x 24"	134	\$1,717	\$1,803
S2-766-S00	2S-766-S00	D/F Adder	48" x 36-3/16" x 24"	111	\$1,317	\$1,383
S1-686-S00	1S-686-S00	D/F Starter	48" x 37-3/16" x 32"	145	\$1,860	\$1,953
S2-686-S00	2S-686-S00	D/F Adder	48" x 36-3/16" x 32"	122	\$1,464	\$1,538

42"H Wood Shelves

2 Adjustable Shelves and 1 Base Shelf per Side

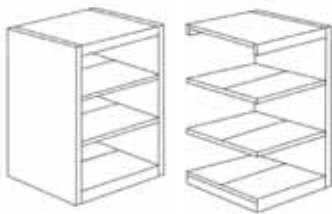

S1-987-S00	1S-987-S00	D/F Starter	42" x 37-3/16" x 20"	101	\$1,512	\$1,588
S2-987-S00	2S-987-S00	D/F Adder	42" x 36-3/16" x 20"	86	\$1,130	\$1,186
S1-991-S00	1S-991-S00	D/F Starter	42" x 37-3/16" x 24"	124	\$1,573	\$1,652
S2-991-S00	2S-991-S00	D/F Adder	42" x 36-3/16" x 24"	105	\$1,199	\$1,259
S1-687-S00	1S-687-S00	D/F Starter	42" x 37-3/16" x 32"	135	\$1,647	\$1,729
S2-687-S00	2S-687-S00	D/F Adder	42" x 36-3/16" x 32"	116	\$1,255	\$1,318

Please specify Wood Finish (Table 1). Details can be found on page GEN 4.

For details regarding Clip & Strip Shelving, Sub Tops or Individual HPL Tops, please reference the Modifications & Up Charges Section located on page MOD 8.

Note: Shelving Backs and Partitions are sold separately and are located in the Shelving Accessories Section on pages CLA 40 and CLA 41.

Wood Picture Book Shelves, Single-Faced

Classic Shelving

Picture Book Shelving

Picture Book Shelving is 12"D with six (6) hardboard dividers per shelf. A 2"H, solid wood back keeps dividers in place.



Oak Catalog No.	Maple Catalog No.	Description	H x W x D	Wt. (lbs.)	Oak Price	Maple Price	
<i>2 Adjustable Picture Book with Divider Shelves and 1 Base Shelf</i>							
S1-931-S00	1S-931-S00	S/F Starter	60-1/2" x 37-3/16" x 12"	105	\$1,276	\$1,340	60-1/2"H Wood Picture Book Shelves
S2-931-S00	2S-931-S00	S/F Adder	60-1/2" x 36-3/16" x 12"	90	\$920	\$966	

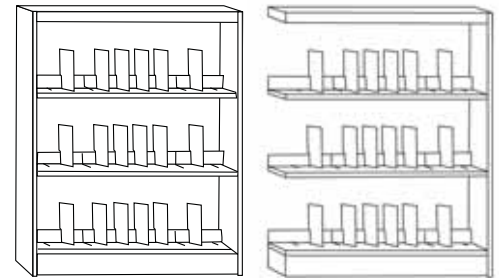

<i>1 Adjustable Picture Book with Divider Shelves and 1 Base Shelf</i>							
S1-929-S00	1S-929-S00	S/F Starter	48" x 37-3/16" x 12"	86	\$1,182	\$1,241	48"H Wood Picture Book Shelves
S2-929-S00	2S-929-S00	S/F Adder	48" x 36-3/16" x 12"	76	\$882	\$926	

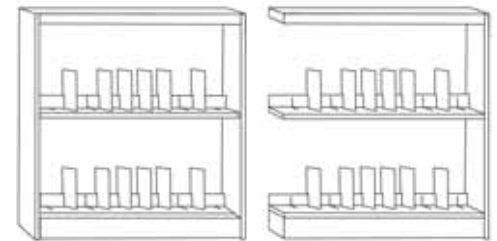

<i>1 Adjustable Picture Book with Divider Shelves and 1 Base Shelf</i>							
S1-932-S00	1S-932-S00	S/F Starter	42" x 37-3/16" x 12"	78	\$982	\$1,031	42"H Wood Picture Book Shelves
S2-932-S00	2S-932-S00	S/F Adder	42" x 36-3/16" x 12"	68	\$703	\$739	



Please specify Wood Finish (Table 1). Details can be found on page GEN 4.

For details regarding Clip & Strip Shelving, Sub Tops or Individual HPL Tops, please reference the Modifications & Up Charges Section located on page MOD 8.

Note: Shelving Backs and Partitions are sold separately and are located in the Shelving Accessories Section on pages CLA 40 and CLA 41.

Classic Shelving

Wood Picture Book Shelves, Double-Faced



Picture Book Shelving

Picture Book Shelving is 12"D with six (6) hardboard dividers per shelf. A 2"H, solid wood back keeps dividers in place.

	Oak Catalog No.	Maple Catalog No.	Description	H x W x D	Wt. (lbs.)	Oak Price	Maple Price
60-1/2"H Wood Picture Book Shelves	<u>2 Adjustable Picture Book with Divider Shelves and 1 Base Shelf per Side</u>						
	S1-933-S00	1S-933-S00	D/F Starter	60-1/2" x 37-3/16" x 24"	180	\$2,430	\$2,551
	S2-933-S00	2S-933-S00	D/F Adder	60-1/2" x 36-3/16" x 24"	152	\$1,780	\$1,869

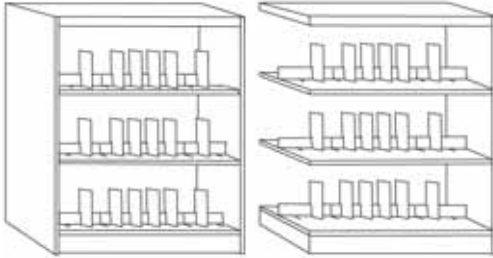

	Oak Catalog No.	Maple Catalog No.	Description	H x W x D	Wt. (lbs.)	Oak Price	Maple Price
48"H Wood Picture Book Shelves	<u>1 Adjustable Picture Book with Divider Shelves and 1 Base Shelf per Side</u>						
	S1-930-S00	1S-930-S00	D/F Starter	48" x 37-3/16" x 24"	149	\$1,887	\$1,981
	S2-930-S00	2S-930-S00	D/F Adder	48" x 36-3/16" x 24"	130	\$1,449	\$1,522

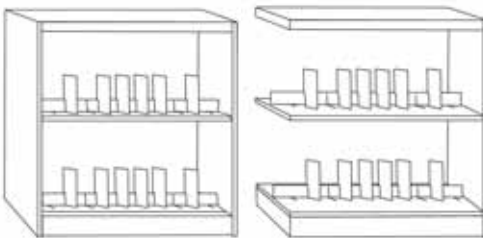

	Oak Catalog No.	Maple Catalog No.	Description	H x W x D	Wt. (lbs.)	Oak Price	Maple Price
42"H Wood Picture Book Shelves	<u>1 Adjustable Picture Book with Divider Shelves and 1 Base Shelf per Side</u>						
	S1-934-S00	1S-934-S00	D/F Starter	42" x 37-3/16" x 24"	130	\$1,684	\$1,768
	S2-934-S00	2S-934-S00	D/F Adder	42" x 36-3/16" x 24"	110	\$1,373	\$1,442

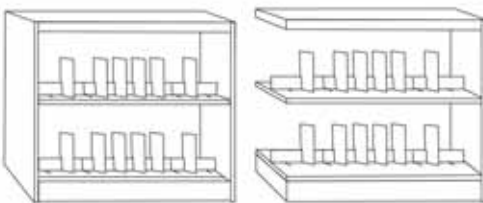

Please specify Wood Finish (Table 1). Details can be found on page GEN 4.

For details regarding Clip & Strip Shelving, Sub Tops or Individual HPL Tops, please reference the Modifications & Up Charges Section located on page MOD 8.

Note: Shelving Backs and Partitions are sold separately and are located in the Shelving Accessories Section on pages CLA 40 and CLA 41.

Glass Door Shelving

Each unit has sliding 1/4" thick laminated glass doors to protect shelved items. A solid back and door lock ensures safe storage. Door pulls are provided. Doors slide smoothly in aluminum tracks at top and bottom. Wood shelves are 9"D.



Oak Catalog No.	Maple Catalog No.	Description	H x W x D	Wt. (lbs.)	Oak Price	Maple Price
-----------------	-------------------	-------------	-----------	------------	-----------	-------------

4 Adjustable Shelves, 1 Fixed Shelf and 1 Base Shelf

82"H Wood Shelves

S1-950-S00	1S-950-S00	S/F Starter	82" x 37-3/16" x 12"	290	\$5,278	\$5,542
S2-950-S00	2S-950-S00	S/F Adder	82" x 36-3/16" x 12"	260	\$4,637	\$4,869



4 Adjustable Shelves and 1 Base Shelf

72"H Wood Shelves

S1-885-S00	1S-885-S00	S/F Starter	72" x 37-3/16" x 12"	270	\$4,855	\$5,098
S2-885-S00	2S-885-S00	S/F Adder	72" x 36-3/16" x 12"	240	\$4,266	\$4,479



4 Adjustable Shelves and 1 Base Shelf

60-1/2"H Wood Shelves

S1-954-S00	1S-954-S00	S/F Starter	60-1/2" x 37-3/16" x 12"	230	\$4,466	\$4,690
S2-954-S00	2S-954-S00	S/F Adder	60-1/2" x 36-3/16" x 12"	200	\$3,960	\$4,158



2 Adjustable Shelves and 1 Base Shelf

48"H Wood Shelves

S1-955-S00	1S-955-S00	S/F Starter	48" x 37-3/16" x 12"	200	\$4,015	\$4,216
S2-955-S00	2S-955-S00	S/F Adder	48" x 36-3/16" x 12"	160	\$3,571	\$3,750



2 Adjustable Shelves and 1 Base Shelf

42"H Wood Shelves

S1-680-S00	1S-680-S00	S/F Starter	42" x 37-3/16" x 12"	180	\$3,563	\$3,742
S2-680-S00	2S-680-S00	S/F Adder	42" x 36-3/16" x 12"	140	\$3,188	\$3,348



Please specify Wood Finish (Table 1). Details can be found on page GEN 4.
For details regarding Clip & Strip Shelving, Sub Tops or Individual HPL Tops, please reference the Modifications & Up Charges Section located on page MOD 8.

Classic Shelving

Wood with Glass Door, Double-Faced





Glass Door Shelving

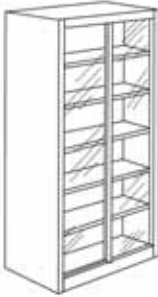
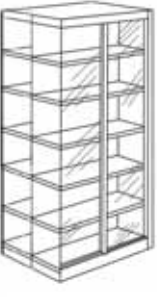

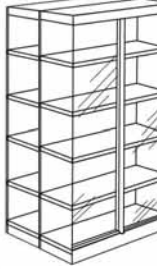
Each unit has sliding 1/4" thick laminated glass doors to protect shelved items. A solid back and door lock ensures safe storage. Door pulls are provided. Doors slide smoothly in aluminum tracks at top and bottom. Wood shelves are 9"D.

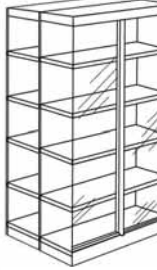
	Oak Catalog No.	Maple Catalog No.	Description	H x W x D	Wt. (lbs.)	Oak Price	Maple Price
82"H Wood Shelves	<i>4 Adjustable Shelves, 1 Fixed Shelf and 1 Base Shelf per Side</i>						
	S1-690-S00	1S-690-S00	D/F Starter	82" x 37-3/16" x 24"	551	\$9,060	\$9,513
	S2-690-S00	2S-690-S00	D/F Adder	82" x 36-3/16" x 24"	494	\$8,605	\$9,035

72"H Wood Shelves	<i>4 Adjustable Shelves and 1 Base Shelf per Side</i>						
	S1-886-S00	1S-886-S00	D/F Starter	72" x 37-3/16" x 24"	513	\$8,153	\$8,560
	S2-886-S00	2S-886-S00	D/F Adder	72" x 36-3/16" x 24"	456	7,744	\$8,131

60-1/2"H Wood Shelves	<i>4 Adjustable Shelves and 1 Base Shelf per Side</i>						
	S1-691-S00	1S-691-S00	D/F Starter	60-1/2" x 37-3/16" x 24"	437	\$7,377	\$7,746
	S2-691-S00	2S-691-S00	D/F Adder	60-1/2" x 36-3/16" x 24"	380	\$6,958	\$7,306

48"H Wood Shelves	<i>2 Adjustable Shelves and 1 Base Shelf per Side</i>						
	S1-682-S00	1S-682-S00	D/F Starter	48" x 37-3/16" x 24"	380	\$6,778	\$7,117
	S2-682-S00	2S-682-S00	D/F Adder	48" x 36-3/16" x 24"	304	\$6,494	\$6,819

42"H Wood Shelves	<i>2 Adjustable Shelves and 1 Base Shelf per Side</i>						
	S1-681-S00	1S-681-S00	D/F Starter	42" x 37-3/16" x 24"	342	\$6,075	\$6,379
	S2-681-S00	2S-681-S00	D/F Adder	42" x 36-3/16" x 24"	266	\$5,818	\$6,109

Please specify Wood Finish (Table 1). Details can be found on page GEN 4.
For details regarding Clip & Strip Shelving, Sub Tops or Individual HPL Tops, please reference the Modifications & Up Charges Section located on page MOD 8.

Wood Periodical Display Shelves, Single-Faced

Classic Shelving

Periodical Display Shelving

Periodical Display Shelves are 13"H with a 3/4"H retaining lip. The display shelves are adjustable on a pin and hole system but they do not tilt. Each sloping display shelf has a 13-3/4"H clear display area.

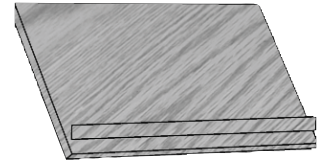

Oak Catalog No.	Maple Catalog No.	Description	H x W x D	Wt. (lbs.)	Oak Price	Maple Price
-----------------	-------------------	-------------	-----------	------------	-----------	-------------

5 Sloping Shelves, 4 Flat Shelves (1 Fixed Shelf) and 1 Base Shelf

82"H Wood Periodical Display Shelves

S1-918-S00	1S-918-S00	S/F Starter	82" x 37-3/16" x 12"	120	\$2,009	\$2,109
S2-918-S00	2S-918-S00	S/F Adder	82" x 36-3/16" x 12"	100	\$1,528	\$1,604



4 Sloping Shelves, 3 Flat Shelves and 1 Base Shelf

72"H Wood Periodical Display Shelves

S1-875-S00	1S-875-S00	S/F Starter	72" x 37-3/16" x 12"	114	\$1,743	\$1,830
S2-875-S00	2S-875-S00	S/F Adder	72" x 36-3/16" x 12"	95	\$1,304	\$1,369



3 Sloping Shelves, 2 Flat Shelves and 1 Base Shelf

60-1/2"H Wood Periodical Display Shelves

S1-920-S00	1S-920-S00	S/F Starter	60-1/2" x 37-3/16" x 12"	105	\$1,473	\$1,547
S2-920-S00	2S-920-S00	S/F Adder	60-1/2" x 36-3/16" x 12"	90	\$1,080	\$1,134

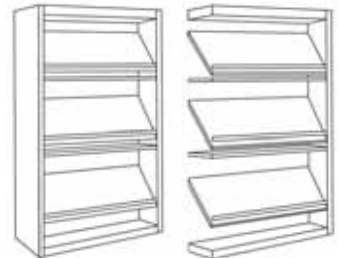

2 Sloping Shelves, 1 Flat Shelf and 1 Base Shelf

48"H Wood Periodical Display Shelves

S1-919-S00	1S-919-S00	S/F Starter	48" x 37-3/16" x 12"	90	\$1,290	\$1,354
S2-919-S00	2S-919-S00	S/F Adder	48" x 36-3/16" x 12"	80	\$996	\$1,046



2 Sloping Shelves, 1 Flat Shelf and 1 Base Shelf

42"H Wood Periodical Display Shelves

S1-921-S00	1S-921-S00	S/F Starter	42" x 37-3/16" x 12"	80	\$1,113	\$1,169
S2-921-S00	2S-921-S00	S/F Adder	42" x 36-3/16" x 12"	70	\$913	\$958



Please specify Wood Finish (Table 1). Details can be found on page GEN 4.
For details regarding Clip & Strip Shelving, Sub Tops or Individual HPL Tops, please reference the Modifications & Up Charges Section located on page MOD 8.

Note: Shelving Backs and Partitions are sold separately and are located in the Shelving Accessories Section on pages CLA 40 and CLA 41.

Classic Shelving

Wood Periodical Display Shelves, Double-Faced

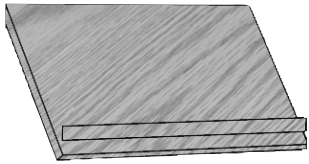

Periodical Display Shelving

Periodical Display Shelves are 13"H with a 3/4"H retaining lip. The display shelves are adjustable on a pin and hole system but they do not tilt. Each sloping display shelf has a 13-3/4"H clear display area.

	Oak Catalog No.	Maple Catalog No.	Description	H x W x D	Wt. (lbs.)	Oak Price	Maple Price
82"H Wood Periodical Display Shelves							
<i>5 Sloping Shelves, 4 Flat Shelves (1 Fixed Shelf) and 1 Base Shelf per Side</i>							
	S1-922-S00	1S-922-S00	D/F Starter	82" x 37-3/16" x 24"	230	\$3,644	\$3,826
	S2-922-S00	2S-922-S00	D/F Adder	82" x 36-3/16" x 24"	194	\$3,068	\$3,222
72"H Wood Periodical Display Shelves							
<i>4 Sloping Shelves, 3 Flat Shelves and 1 Base Shelf per Side</i>							
	S1-876-S00	1S-876-S00	D/F Starter	72" x 37-3/16" x 24"	210	\$3,316	\$3,482
	S2-876-S00	2S-876-S00	D/F Adder	72" x 36-3/16" x 24"	180	\$2,793	\$2,932
60-1/2"H Wood Periodical Display Shelves							
<i>3 Sloping Shelves, 2 Flat Shelves and 1 Base Shelf per Side</i>							
	S1-923-S00	1S-923-S00	D/F Starter	60-1/2" x 37-3/16" x 24"	185	\$2,624	\$2,755
	S2-923-S00	2S-923-S00	D/F Adder	60-1/2" x 36-3/16" x 24"	157	\$2,060	\$2,163
48"H Wood Periodical Display Shelves							
<i>2 Sloping Shelves, 1 Flat Shelf and 1 Base Shelf per Side</i>							
	S1-925-S00	1S-925-S00	D/F Starter	48" x 37-3/16" x 24"	150	\$2,362	\$2,480
	S2-925-S00	2S-925-S00	D/F Adder	48" x 36-3/16" x 24"	130	\$1,794	\$1,883
42"H Wood Periodical Display Shelves							
<i>2 Sloping Shelves, 1 Flat Shelf and 1 Base Shelf per Side</i>							
	S1-924-S00	1S-924-S00	D/F Starter	42" x 37-3/16" x 24"	130	\$2,106	\$2,211
	S2-924-S00	2S-924-S00	D/F Adder	42" x 36-3/16" x 24"	111	\$1,528	\$1,604

Please specify Wood Finish (Table 1). Details can be found on page GEN 4.
For details regarding Clip & Strip Shelving, Sub Tops or Individual HPL Tops, please reference
the Modifications & Up Charges Section located on page MOD 8.

Note: Shelving Backs and Partitions are sold separately and are located in the Shelving Accessories Section on pages CLA 40 and CLA 41.

Wood Tilt and Store Shelves, Single-Faced

Classic Shelving

Tilt and Store Shelving

Sloping display shelves have a 13"H clear display area and lift up to expose flat storage shelves via a pivot hinge. Storage space is concealed when display shelves are in normal position.

Note: Tilt and Store Shelving is available in 16" depth ONLY.

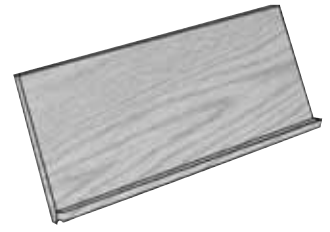

Oak Catalog No.	Maple Catalog No.	Description	H x W x D	Wt. (lbs.)	Oak Price	Maple Price
-----------------	-------------------	-------------	-----------	------------	-----------	-------------

5 Tilting Shelves, 4 Flat Shelves (1 Fixed Shelf) and 1 Base Shelf

S1-935-S00	1S-935-S00	S/F Starter	82" x 37-3/16" x 16"	250	\$2,432	\$2,553
S2-935-S00	2S-935-S00	S/F Adder	82" x 36-3/16" x 16"	214	\$1,956	\$2,054

82"H Wood Tilt & Store Shelves



4 Tilting Shelves, 3 Flat Shelves and 1 Base Shelf

S1-880-S00	1S-880-S00	S/F Starter	72" x 37-3/16" x 16"	220	\$2,213	\$2,324
S2-880-S00	2S-880-S00	S/F Adder	72" x 36-3/16" x 16"	180	\$1,780	\$1,869

72"H Wood Tilt & Store Shelves

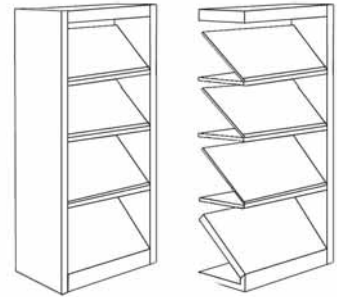

3 Tilting Shelves, 2 Flat Shelves and 1 Base Shelf

S1-936-S00	1S-936-S00	S/F Starter	60-1/2" x 37-3/16" x 16"	180	\$1,876	\$1,970
S2-936-S00	2S-936-S00	S/F Adder	60-1/2" x 36-3/16" x 16"	130	\$1,426	\$1,497

60-1/2"H Wood Tilt & Store Shelves



2 Tilting Shelves, 1 Flat Shelf and 1 Base Shelf

S1-938-S00	1S-938-S00	S/F Starter	48" x 37-3/16" x 16"	120	\$1,634	\$1,716
S2-938-S00	2S-938-S00	S/F Adder	48" x 36-3/16" x 16"	110	\$1,251	\$1,314

48"H Wood Tilt & Store Shelves

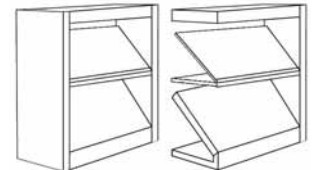

2 Tilting Shelves, 1 Flat Shelf and 1 Base Shelf

S1-937-S00	1S-937-S00	S/F Starter	42" x 37-3/16" x 16"	100	\$1,391	\$1,460
S2-937-S00	2S-937-S00	S/F Adder	42" x 36-3/16" x 16"	90	\$1,075	\$1,129

42"H Wood Tilt & Store Shelves

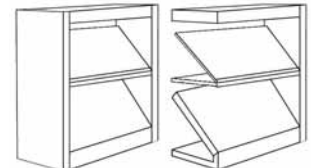

Please specify Wood Finish (Table 1). Details can be found on page GEN 4.
For details regarding Clip & Strip Shelving, Sub Tops or Individual HPL Tops, please reference the Modifications & Up Charges Section located on page MOD 8.

Note: Shelving Backs and Partitions are sold separately and are located in the Shelving Accessories Section on pages CLA 40 and CLA 41.

Classic Shelving

Wood Tilt and Store Shelves, Double-Faced

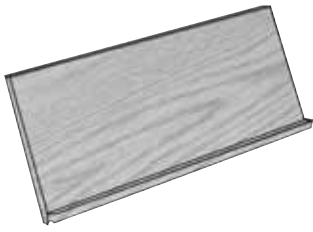

Tilt and Store Shelving

Sloping display shelves have a 13"H clear display area and lift up to expose flat storage shelves via a pivot hinge. Storage space is concealed when display shelves are in normal position.

Note: Tilt and Store Shelving is available in 16" depth ONLY.

82"H Wood Tilt & Store Shelves

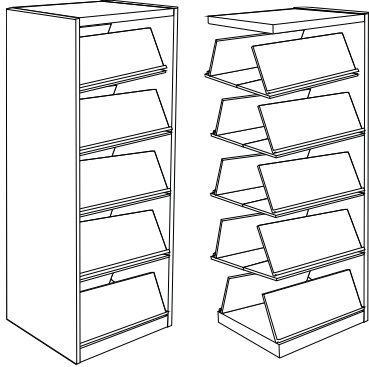

Oak Catalog No.	Maple Catalog No.	Description	H x W x D	Wt. (lbs.)	Oak Price	Maple Price
<i>5 Tilting Shelves, 4 Flat Shelves and 1 Base Shelf per Side</i>						
S1-945-S00	1S-945-S00	D/F Starter	82" x 37-3/16" x 32"	450	\$4,379	\$4,596
S2-945-S00	2S-945-S00	D/F Adder	82" x 36-3/16" x 32"	385	\$3,521	\$3,698

72"H Wood Tilt & Store Shelves

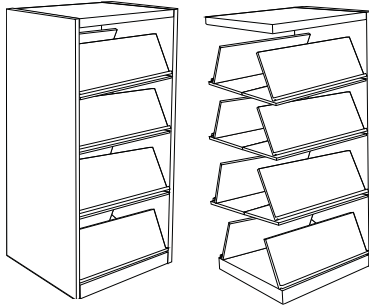

Oak Catalog No.	Maple Catalog No.	Description	H x W x D	Wt. (lbs.)	Oak Price	Maple Price
<i>4 Tilting Shelves, 3 Flat Shelves and 1 Base Shelf per Side</i>						
S1-840-S00	1S-840-S00	D/F Starter	72" x 37-3/16" x 32"	396	\$3,985	\$4,183
S2-840-S00	2S-840-S00	D/F Adder	72" x 36-3/16" x 32"	324	\$3,203	\$3,364

60-1/2"H Wood Tilt & Store Shelves

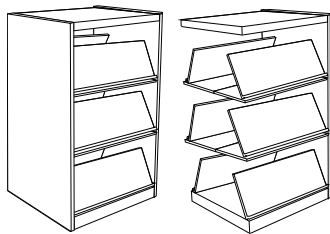

Oak Catalog No.	Maple Catalog No.	Description	H x W x D	Wt. (lbs.)	Oak Price	Maple Price
<i>3 Tilting Shelves, 2 Flat Shelves and 1 Base Shelf per Side</i>						
S1-946-S00	1S-946-S00	D/F Starter	60-1/2" x 37-3/16" x 32"	324	\$3,377	\$3,546
S2-946-S00	2S-946-S00	D/F Adder	60-1/2" x 36-3/16" x 32"	234	\$2,565	\$2,694

48"H Wood Tilt & Store Shelves

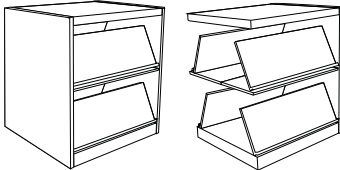

Oak Catalog No.	Maple Catalog No.	Description	H x W x D	Wt. (lbs.)	Oak Price	Maple Price
<i>2 Tilting Shelves, 1 Flat Shelf and 1 Base Shelf per Side</i>						
S1-948-S00	1S-948-S00	D/F Starter	48" x 37-3/16" x 32"	216	\$2,940	\$3,088
S2-948-S00	2S-948-S00	D/F Adder	48" x 36-3/16" x 32"	198	\$2,250	\$2,364

42"H Wood Tilt & Store Shelves

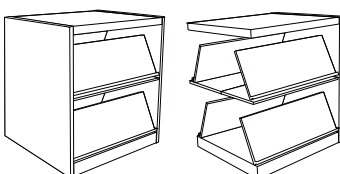

Oak Catalog No.	Maple Catalog No.	Description	H x W x D	Wt. (lbs.)	Oak Price	Maple Price
<i>2 Tilting Shelves, 1 Flat Shelf and 1 Base Shelf per Side</i>						
S1-947-S00	1S-947-S00	D/F Starter	42" x 37-3/16" x 32"	180	\$2,504	\$2,629
S2-947-S00	2S-947-S00	D/F Adder	42" x 36-3/16" x 32"	162	\$1,934	\$2,033

Please specify Wood Finish (Table 1). Details can be found on page GEN 4.
For details regarding Clip & Strip Shelving, Sub Tops or Individual HPL Tops, please reference the Modifications & Up Charges Section located on page MOD 8.

Note: Shelving Backs and Partitions are sold separately and are located in the Shelving Accessories Section on pages CLA 40 and CLA 41.

Oak Catalog No.	Maple Catalog No.	Description	H x W x D	Wt. (lbs.)	Oak Price	Maple Price
5 Adjustable Metal Shelves, 1 Fixed Metal Shelf and 1 Wood Base Shelf						
S5-960-S00	5S-960-S00	S/F Starter	90" x 37-3/16" x 10"	103	\$1,238	\$1,301
S6-960-S00	6S-960-S00	S/F Adder	90" x 36-3/16" x 10"	90	\$938	\$985
S5-967-S00	5S-967-S00	S/F Starter	90" x 37-3/16" x 12"	122	\$1,393	\$1,463
S6-967-S00	6S-967-S00	S/F Adder	90" x 36-3/16" x 12"	102	\$1,002	\$1,052



90"H Omega Shelves



4 Adjustable Metal Shelves, 1 Fixed Metal Shelf and 1 Wood Base Shelf						
S5-976-S00	5S-976-S00	S/F Starter	82" x 37-3/16" x 10"	93	\$1,130	\$1,186
S6-976-S00	6S-976-S00	S/F Adder	82" x 36-3/16" x 10"	80	\$858	\$901
S5-977-S00	5S-977-S00	S/F Starter	82" x 37-3/16" x 12"	112	\$1,268	\$1,331
S6-977-S00	6S-977-S00	S/F Adder	82" x 36-3/16" x 12"	92	\$929	\$975

82"H Omega Shelves



4 Adjustable Metal Shelves and 1 Wood Base Shelf						
S5-861-S00	5S-861-S00	S/F Starter	72" x 37-3/16" x 10"	88	\$1,031	\$1,082
S6-861-S00	6S-861-S00	S/F Adder	72" x 36-3/16" x 10"	75	\$787	\$826
S5-863-S00	5S-863-S00	S/F Starter	72" x 37-3/16" x 12"	102	\$1,156	\$1,214
S6-863-S00	6S-863-S00	S/F Adder	72" x 36-3/16" x 12"	87	\$862	\$905

72"H Omega Shelves



4 Adjustable Metal Shelves and 1 Wood Base Shelf						
S5-979-S00	5S-979-S00	S/F Starter	60-1/2" x 37-3/16" x 10"	75	\$933	\$979
S6-979-S00	6S-979-S00	S/F Adder	60-1/2" x 36-3/16" x 10"	65	\$714	\$750
S5-988-S00	5S-988-S00	S/F Starter	60-1/2" x 37-3/16" x 12"	96	\$1,046	\$1,098
S6-988-S00	6S-988-S00	S/F Adder	60-1/2" x 36-3/16" x 12"	81	\$794	\$833

60-1/2"H Omega Shelves



Please specify Wood Finish (Table 1) and Metal Color (Table 3). Details can be found on pages GEN 4 and GEN 5.

Note: Shelving Backs and Partitions are sold separately and are located in the Shelving Accessories Section on pages CLA 40 and CLA 41.
Clip & Strip Shelving CANNOT be used with Omega Shelves.



Oak Catalog No.	Maple Catalog No.	Description	H x W x D	Wt. (lbs.)	Oak Price	Maple Price
-----------------	-------------------	-------------	-----------	------------	-----------	-------------

48"H Omega Shelves

2 Adjustable Metal Shelves and 1 Wood Base Shelf

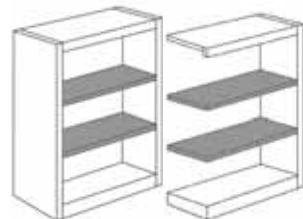

S5-761-S00	5S-761-S00	S/F Starter	48" x 37-3/16" x 10"	71	\$801	\$840
S6-761-S00	6S-761-S00	S/F Adder	48" x 36-3/16" x 10"	63	\$584	\$614
S5-762-S00	5S-762-S00	S/F Starter	48" x 37-3/16" x 12"	84	\$851	\$894
S6-762-S00	6S-762-S00	S/F Adder	48" x 36-3/16" x 12"	74	\$613	\$644

42"H Omega Shelves

2 Adjustable Metal Shelves and 1 Wood Base Shelf

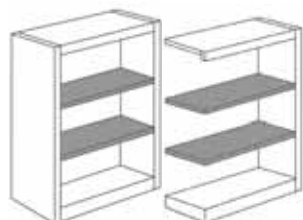

S5-981-S00	5S-981-S00	S/F Starter	42" x 37-3/16" x 10"	61	\$765	\$803
S6-981-S00	6S-981-S00	S/F Adder	42" x 36-3/16" x 10"	53	\$551	\$578
S5-989-S00	5S-989-S00	S/F Starter	42" x 37-3/16" x 12"	74	\$802	\$842
S6-989-S00	6S-989-S00	S/F Adder	42" x 36-3/16" x 12"	64	\$568	\$597

Please specify Wood Finish (Table 1) and Metal Color (Table 3). Details can be found on pages GEN 4 and GEN 5.

Note: Shelving Backs and Partitions are sold separately and are located in the Shelving Accessories Section on pages CLA 40 and CLA 41.
Clip & Strip Shelving CANNOT be used with Omega Shelves.

Oak Catalog No.	Maple Catalog No.	Description	H x W x D	Wt. (lbs.)	Oak Price	Maple Price
5 Adjustable Metal Shelves, 1 Fixed Metal Shelf and 1 Wood Base Shelf per Side						
S5-969-S00	5S-969-S00	D/F Starter	90" x 37-3/16" x 20"	185	\$2,080	\$2,184
S6-969-S00	6S-969-S00	D/F Adder	90" x 36-3/16" x 20"	153	\$1,565	\$1,644
S5-973-S00	5S-973-S00	D/F Starter	90" x 37-3/16" x 24"	224	\$2,493	\$2,618
S6-973-S00	6S-973-S00	D/F Adder	90" x 36-3/16" x 24"	188	\$1,731	\$1,818



90"H Omega Shelves

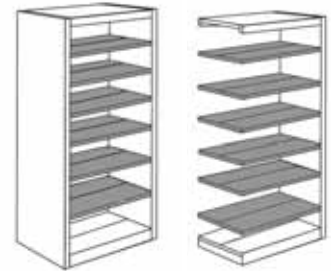

4 Adjustable Metal Shelves, 1 Fixed Metal Shelf and 1 Wood Base Shelf per Side						
S5-983-S00	5S-983-S00	D/F Starter	82" x 37-3/16" x 20"	175	\$1,976	\$2,075
S6-983-S00	6S-983-S00	D/F Adder	82" x 36-3/16" x 20"	143	\$1,518	\$1,594
S5-990-S00	5S-990-S00	D/F Starter	82" x 37-3/16" x 24"	214	\$2,325	\$2,442
S6-990-S00	6S-990-S00	D/F Adder	82" x 36-3/16" x 24"	178	\$1,675	\$1,758

82"H Omega Shelves

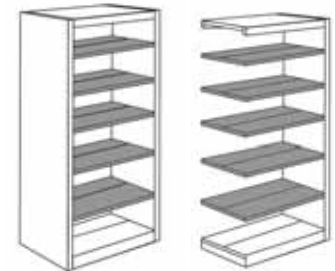

4 Adjustable Metal Shelves and 1 Wood Base Shelf per Side						
S5-865-S00	5S-865-S00	D/F Starter	72" x 37-3/16" x 20"	160	\$1,876	\$1,970
S6-865-S00	6S-865-S00	D/F Adder	72" x 36-3/16" x 20"	128	\$1,471	\$1,545
S5-866-S00	5S-866-S00	D/F Starter	72" x 37-3/16" x 24"	199	\$2,171	\$2,279
S6-866-S00	6S-866-S00	D/F Adder	72" x 36-3/16" x 24"	163	\$1,620	\$1,701

72"H Omega Shelves

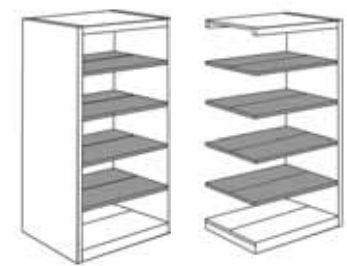

4 Adjustable Metal Shelves and 1 Wood Base Shelf per Side						
S5-985-S00	5S-985-S00	D/F Starter	60-1/2" x 37-3/16" x 20"	139	\$1,779	\$1,868
S6-985-S00	6S-985-S00	D/F Adder	60-1/2" x 36-3/16" x 20"	115	\$1,425	\$1,496
S5-986-S00	5S-986-S00	D/F Starter	60-1/2" x 37-3/16" x 24"	170	\$2,015	\$2,116
S6-986-S00	6S-986-S00	D/F Adder	60-1/2" x 36-3/16" x 24"	142	\$1,563	\$1,642

60-1/2"H Omega Shelves

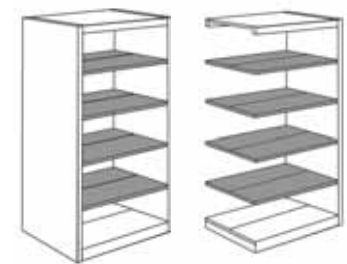

Please specify Wood Finish (Table 1) and Metal Color (Table 3). Details can be found on pages GEN 4 and GEN 5.

Note: Shelving Backs and Partitions are sold separately and are located in the Shelving Accessories Section on pages CLA 40 and CLA 41. Clip & Strip Shelving CANNOT be used with Omega Shelves.



48"H Omega Shelves

Oak Catalog No.	Maple Catalog No.	Description	H x W x D	Wt. (lbs.)	Oak Price	Maple Price
<i>2 Adjustable Metal Shelves and 1 Wood Base Shelf per Side</i>						
S5-765-S00	5S-765-S00	D/F Starter	48" x 37-3/16" x 20"	111	\$1,405	\$1,475
S6-765-S00	6S-765-S00	D/F Adder	48" x 36-3/16" x 20"	96	\$1,031	\$1,082
S5-766-S00	5S-766-S00	D/F Starter	48" x 37-3/16" x 24"	134	\$1,518	\$1,594
S6-766-S00	6S-766-S00	D/F Adder	48" x 36-3/16" x 24"	111	\$1,138	\$1,195

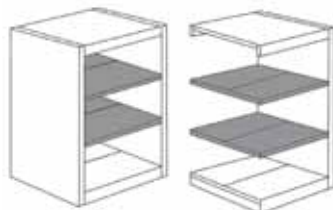

42"H Omega Shelves

Oak Catalog No.	Maple Catalog No.	Description	H x W x D	Wt. (lbs.)	Oak Price	Maple Price
<i>2 Adjustable Metal Shelves and 1 Wood Base Shelf per Side</i>						
S5-987-S00	5S-987-S00	D/F Starter	42" x 37-3/16" x 20"	101	\$1,311	\$1,376
S6-987-S00	6S-987-S00	D/F Adder	42" x 36-3/16" x 20"	86	\$933	\$979
S5-991-S00	5S-991-S00	D/F Starter	42" x 37-3/16" x 24"	124	\$1,393	\$1,463
S6-991-S00	6S-991-S00	D/F Adder	42" x 36-3/16" x 24"	105	\$1,032	\$1,083

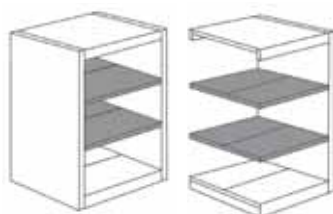

Please specify Wood Finish (Table 1) and Metal Color (Table 3). Details can be found on pages GEN 4 and GEN 5.

Note: Shelving Backs and Partitions are sold separately and are located in the Shelving Accessories Section on pages CLA 40 and CLA 41.
Clip & Strip Shelving CANNOT be used with Omega Shelves.

Oak Catalog No.	Maple Catalog No.	Description	H x W x D	Wt. (lbs.)	Oak Price	Maple Price
5 Adjustable Metal Shelves, 1 Fixed Metal Shelf and 1 Metal Base Shelf						
S7-960-S00	7S-960-S00	S/F Starter	90" x 37-3/16" x 10"	103	\$1,238	\$1,301
S8-960-S00	8S-960-S00	S/F Adder	90" x 36-3/16" x 10"	90	\$938	\$985
S7-967-S00	7S-967-S00	S/F Starter	90" x 37-3/16" x 12"	122	\$1,393	\$1,463
S8-967-S00	8S-967-S00	S/F Adder	90" x 36-3/16" x 12"	102	\$1,002	\$1,052



90"H Omega Book Stop Shelves



4 Adjustable Metal Shelves, 1 Fixed Metal Shelf and 1 Metal Base Shelf						
S7-976-S00	7S-976-S00	S/F Starter	82" x 37-3/16" x 10"	93	\$1,265	\$1,328
S8-976-S00	8S-976-S00	S/F Adder	82" x 36-3/16" x 10"	80	\$985	\$1,034
S7-977-S00	7S-977-S00	S/F Starter	82" x 37-3/16" x 12"	112	\$1,425	\$1,496
S8-977-S00	8S-977-S00	S/F Adder	82" x 36-3/16" x 12"	92	\$1,059	\$1,111

82"H Omega Book Stop Shelves



4 Adjustable Metal Shelves and 1 Metal Base Shelf						
S7-861-S00	7S-861-S00	S/F Starter	72" x 37-3/16" x 10"	88	\$1,133	\$1,190
S8-861-S00	8S-861-S00	S/F Adder	72" x 36-3/16" x 10"	75	\$884	\$928
S7-863-S00	7S-863-S00	S/F Starter	72" x 37-3/16" x 12"	102	\$1,295	\$1,359
S8-863-S00	8S-863-S00	S/F Adder	72" x 36-3/16" x 12"	87	\$960	\$1,008

72"H Omega Book Stop Shelves



4 Adjustable Metal Shelves and 1 Metal Base Shelf						
S7-979-S00	7S-979-S00	S/F Starter	60-1/2" x 37-3/16" x 10"	75	\$1,002	\$1,052
S8-979-S00	8S-979-S00	S/F Adder	60-1/2" x 36-3/16" x 10"	65	\$784	\$823
S7-988-S00	7S-988-S00	S/F Starter	60-1/2" x 37-3/16" x 12"	96	\$1,165	\$1,223
S8-988-S00	8S-988-S00	S/F Adder	60-1/2" x 36-3/16" x 12"	81	\$861	\$904

60-1/2"H Omega Book Stop Shelves



Please specify Wood Finish (Table 1) and Metal Color (Table 3). Details can be found on pages GEN 4 and GEN 5.

Note: Clip & Strip Shelving CANNOT be used with Omega Shelves. Shelving Backs and Partitions CANNOT be used with Omega Book Stop Shelving.



Oak Catalog No.	Maple Catalog No.	Description	H x W x D	Wt. (lbs.)	Oak Price	Maple Price
-----------------	-------------------	-------------	-----------	------------	-----------	-------------

48"H Omega Book Stop Shelves

2 Adjustable Metal Shelves and 1 Metal Base Shelf

S7-761-S00	7S-761-S00	S/F Starter	48" x 37-3/16" x 10"	71	\$843	\$885
S8-761-S00	8S-761-S00	S/F Adder	48" x 36-3/16" x 10"	63	\$627	\$658
S7-762-S00	7S-762-S00	S/F Starter	48" x 37-3/16" x 12"	84	\$914	\$959
S8-762-S00	8S-762-S00	S/F Adder	48" x 36-3/16" x 12"	74	\$661	\$694



42"H Omega Book Stop Shelves

2 Adjustable Metal Shelves and 1 Metal Base Shelf

S7-981-S00	7S-981-S00	S/F Starter	42" x 37-3/16" x 10"	61	\$804	\$844
S8-981-S00	8S-981-S00	S/F Adder	42" x 36-3/16" x 10"	53	\$587	\$617
S7-989-S00	7S-989-S00	S/F Starter	42" x 37-3/16" x 12"	74	\$851	\$894
S8-989-S00	8S-989-S00	S/F Adder	42" x 36-3/16" x 12"	64	\$613	\$644

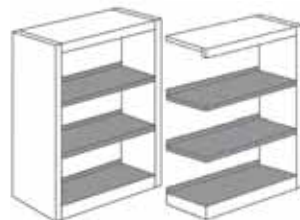

Please specify Wood Finish (Table 1) and Metal Color (Table 3). Details can be found on pages GEN 4 and GEN 5.

Note: Clip & Strip Shelving CANNOT be used with Omega Shelves. Shelving Backs and Partitions CANNOT be used with Omega Book Stop Shelving.

Oak Catalog No.	Maple Catalog No.	Description	H x W x D	Wt. (lbs.)	Oak Price	Maple Price
5 Adjustable Metal Shelves, 1 Fixed Metal Shelf and 1 Metal Base Shelf per Side						
S7-969-S00	7S-969-S00	D/F Starter	90" x 37-3/16" x 20"	185	\$2,420	\$2,541
S8-969-S00	8S-969-S00	D/F Adder	90" x 36-3/16" x 20"	153	\$1,883	\$1,977
S7-973-S00	7S-973-S00	D/F Starter	90" x 37-3/16" x 24"	224	\$2,847	\$2,990
S8-973-S00	8S-973-S00	D/F Adder	90" x 36-3/16" x 24"	188	\$2,057	\$2,159



90"H Omega Book Stop Shelves



4 Adjustable Metal Shelves, 1 Fixed Metal Shelf and 1 Metal Base Shelf per Side						
S7-983-S00	7S-983-S00	D/F Starter	82" x 37-3/16" x 20"	175	\$2,243	\$2,355
S8-983-S00	8S-983-S00	D/F Adder	82" x 36-3/16" x 20"	143	\$1,771	\$1,859
S7-990-S00	7S-990-S00	D/F Starter	82" x 37-3/16" x 24"	214	\$2,601	\$2,730
S8-990-S00	8S-990-S00	D/F Adder	82" x 36-3/16" x 24"	178	\$1,927	\$2,023

82"H Omega Book Stop Shelves



4 Adjustable Metal Shelves and 1 Metal Base Shelf per Side						
S7-865-S00	7S-865-S00	D/F Starter	72" x 37-3/16" x 20"	160	\$2,079	\$2,183
S8-865-S00	8S-865-S00	D/F Adder	72" x 36-3/16" x 20"	128	\$1,665	\$1,748
S7-866-S00	7S-866-S00	D/F Starter	72" x 37-3/16" x 24"	199	\$2,377	\$2,496
S8-866-S00	8S-866-S00	D/F Adder	72" x 36-3/16" x 24"	163	\$1,805	\$1,895

72"H Omega Book Stop Shelves



4 Adjustable Metal Shelves and 1 Metal Base Shelf per Side						
S7-985-S00	7S-985-S00	D/F Starter	60-1/2" x 37-3/16" x 20"	139	\$1,914	\$2,009
S8-985-S00	8S-985-S00	D/F Adder	60-1/2" x 36-3/16" x 20"	115	\$1,561	\$1,639
S7-986-S00	7S-986-S00	D/F Starter	60-1/2" x 37-3/16" x 24"	170	\$2,149	\$2,256
S8-986-S00	8S-986-S00	D/F Adder	60-1/2" x 36-3/16" x 24"	142	\$1,685	\$1,769

60-1/2"H Omega Book Stop Shelves



Please specify Wood Finish (Table 1) and Metal Color (Table 3). Details can be found on pages GEN 4 and GEN 5.

Note: Clip & Strip Shelving CANNOT be used with Omega Shelves. Shelving Backs and Partitions CANNOT be used with Omega Book Stop Shelving.



Oak Catalog No.	Maple Catalog No.	Description	H x W x D	Wt. (lbs.)	Oak Price	Maple Price
-----------------	-------------------	-------------	-----------	------------	-----------	-------------

48"H Omega Book Stop Shelves

2 Adjustable Metal Shelves and 1 Metal Base Shelf per Side

S7-765-S00	7S-765-S00	D/F Starter	48" x 37-3/16" x 20"	111	\$1,493	\$1,568
S8-765-S00	8S-765-S00	D/F Adder	48" x 36-3/16" x 20"	96	\$1,119	\$1,175
S7-766-S00	7S-766-S00	D/F Starter	48" x 37-3/16" x 24"	134	\$1,605	\$1,685
S8-766-S00	8S-766-S00	D/F Adder	48" x 36-3/16" x 24"	111	\$1,224	\$1,285

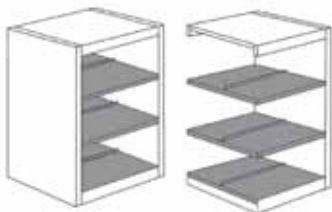

42"H Omega Book Stop Shelves

2 Adjustable Metal Shelves and 1 Metal Base Shelf per Side

S7-987-S00	7S-987-S00	D/F Starter	42" x 37-3/16" x 20"	101	\$1,389	\$1,458
S8-987-S00	8S-987-S00	D/F Adder	42" x 36-3/16" x 20"	86	\$1,009	\$1,059
S7-991-S00	7S-991-S00	D/F Starter	42" x 37-3/16" x 24"	124	\$1,470	\$1,544
S8-991-S00	8S-991-S00	D/F Adder	42" x 36-3/16" x 24"	105	\$1,109	\$1,165



Please specify Wood Finish (Table 1) and Metal Color (Table 3). Details can be found on pages GEN 4 and GEN 5.

Note: Clip & Strip Shelving CANNOT be used with Omega Shelves. Shelving Backs and Partitions CANNOT be used with Omega Book Stop Shelving.

Omega Periodical Display Shelves, Single-Faced

Classic Shelving

Periodical Display Shelving

Periodical Display Shelves are 13"H with a 3/4"H retaining lip. The display shelves are adjustable on a pin and hole system but they do not tilt. Each sloping display shelf has a 13-3/4"H clear display area.

Note: Each metal display shelf receives 6 metal dividers per shelf.

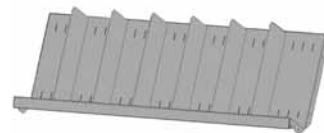

Oak Catalog No.	Maple Catalog No.	Description	H x W x D	Wt. (lbs.)	Oak Price	Maple Price
-----------------	-------------------	-------------	-----------	------------	-----------	-------------

5 Display Metal Shelves, 3 Adjustable Metal Shelves, 1 Fixed Metal Shelf and 1 Wood Base Shelf

S7-918-S00	7S-918-S00	S/F Starter	82" x 37-3/16" x 12"	120	\$1,949	\$2,047
S8-918-S00	8S-918-S00	S/F Adder	82" x 36-3/16" x 12"	100	\$1,483	\$1,557

82"H Omega Periodical Display Shelves

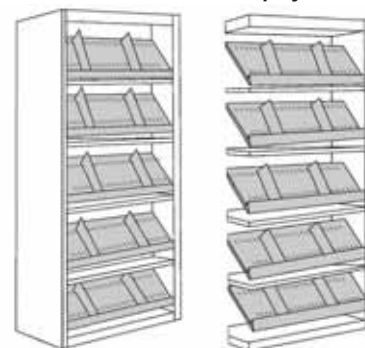

4 Display Metal Shelves, 3 Adjustable Metal Shelves and 1 Wood Base Shelf

S7-875-S00	7S-875-S00	S/F Starter	72" x 37-3/16" x 12"	270	\$1,691	\$1,776
S8-875-S00	8S-875-S00	S/F Adder	72" x 36-3/16" x 12"	240	\$1,266	\$1,329

72"H Omega Periodical Display Shelves

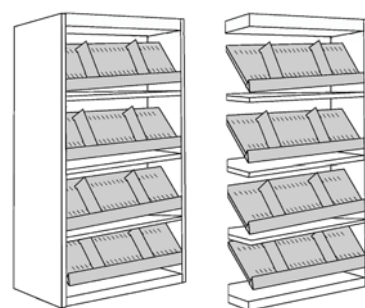

3 Display Metal Shelves, 2 Adjustable Metal Shelves and 1 Wood Base Shelf

S7-920-S00	7S-920-S00	S/F Starter	60-1/2" x 37-3/16" x 12"	230	\$1,431	\$1,502
S8-920-S00	8S-920-S00	S/F Adder	60-1/2" x 36-3/16" x 12"	200	\$1,048	\$1,100

60-1/2"H Omega Periodical Display Shelves

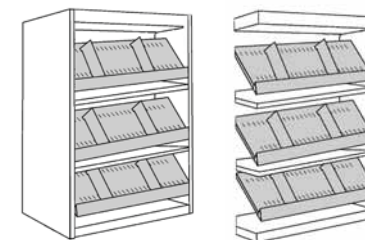

Please specify Wood Finish (Table 1) and Metal Color (Table 3). Details can be found on pages GEN 4 and GEN 5.

Note: Shelving Backs and Partitions are sold separately and are located in the Shelving Accessories Section on pages CLA 40 and CLA 41.
Clip & Strip Shelving CANNOT be used with Omega Shelves.

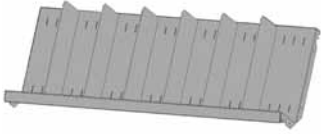

Periodical Display Shelving

Periodical Display Shelves are 13"H with a 3/4"H retaining lip. The display shelves are adjustable on a pin and hole system but they do not tilt. Each sloping display shelf has a 13-3/4"H clear display area.

Note: Each metal display shelf receives 6 metal dividers per shelf.

48"H Omega Periodical Display Shelves

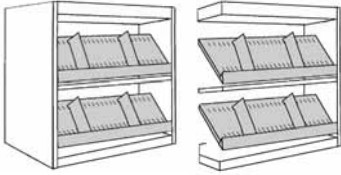

Oak Catalog No.	Maple Catalog No.	Description	H x W x D	Wt. (lbs.)	Oak Price	Maple Price
<i>2 Display Metal Shelves, 1 Adjustable Metal Shelf and 1 Wood Base Shelf</i>						
S7-919-S00	7S-919-S00	S/F Starter	48" x 37-3/16" x 12"	200	\$1,251	\$1,314
S8-919-S00	8S-919-S00	S/F Adder	48" x 36-3/16" x 12"	160	\$967	\$1,016

42"H Omega Periodical Display Shelves

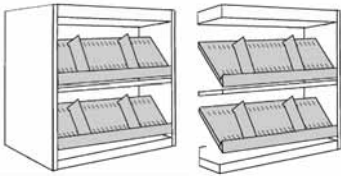

Oak Catalog No.	Maple Catalog No.	Description	H x W x D	Wt. (lbs.)	Oak Price	Maple Price
<i>2 Display Metal Shelves, 1 Adjustable Metal Shelf and 1 Wood Base Shelf</i>						
S7-921-S00	7S-921-S00	S/F Starter	42" x 37-3/16" x 12"	180	\$1,079	\$1,133
S8-921-S00	8S-921-S00	S/F Adder	42" x 36-3/16" x 12"	140	\$886	\$930

Please specify Wood Finish (Table 1) and Metal Color (Table 3). Details can be found on pages GEN 4 and GEN 5.

Note: Shelving Backs and Partitions are sold separately and are located in the Shelving Accessories Section on pages CLA 40 and CLA 41.
Clip & Strip Shelving CANNOT be used with Omega Shelves.

Omega Periodical Display Shelves, Double-Faced

Classic Shelving

Periodical Display Shelving

Periodical Display Shelves are 13"H with a 3/4"H retaining lip. The display shelves are adjustable on a pin and hole system but they do not tilt. Each sloping display shelf has a 13-3/4"H clear display area.

Note: Each metal display shelf receives 6 metal dividers per shelf.

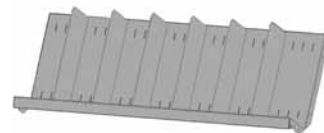

Oak Catalog No.	Maple Catalog No.	Description	H x W x D	Wt. (lbs.)	Oak Price	Maple Price
<u>5 Display Metal Shelves, 3 Adjustable Metal Shelves, 1 Fixed Metal Shelf and 1 Wood Base Shelf per Side</u>						
S7-922-S00	7S-922-S00	D/F Starter	82" x 37-3/16" x 24"	230	\$3,536	\$3,713
S8-922-S00	8S-922-S00	D/F Adder	82" x 36-3/16" x 24"	194	\$2,977	\$3,126

82"H Omega Periodical Display Shelves

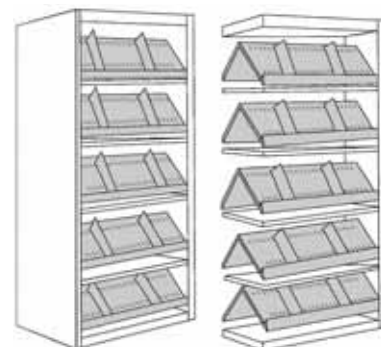

<u>4 Display Metal Shelves, 3 Adjustable Metal Shelves and 1 Wood Base Shelf per Side</u>						
S7-876-S00	7S-876-S00	D/F Starter	72" x 37-3/16" x 24"	210	\$3,217	\$3,378
S8-876-S00	8S-876-S00	D/F Adder	72" x 36-3/16" x 24"	180	\$2,709	\$2,845

72"H Omega Periodical Display Shelves

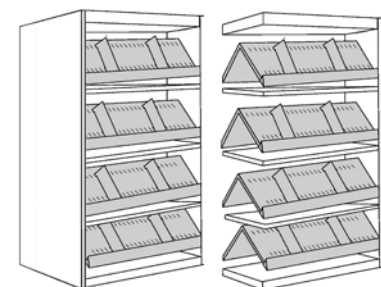

<u>3 Display Metal Shelves, 2 Adjustable Metal Shelves and 1 Wood Base Shelf per Side</u>						
S7-923-S00	7S-923-S00	D/F Starter	60-1/2" x 37-3/16" x 24"	185	\$2,546	\$2,673
S8-923-S00	8S-923-S00	D/F Adder	60-1/2" x 36-3/16" x 24"	157	\$1,999	\$2,099

60-1/2"H Omega Periodical Display Shelves

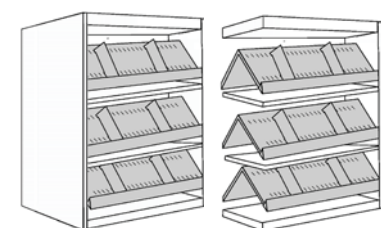

Please specify Wood Finish (Table 1) and Metal Color (Table 3). Details can be found on pages GEN 4 and GEN 5.

Note: Shelving Backs and Partitions are sold separately and are located in the Shelving Accessories Section on pages CLA 40 and CLA 41.
Clip & Strip Shelving CANNOT be used with Omega Shelves.

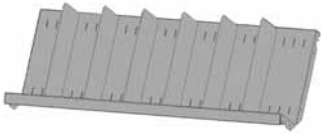

Periodical Display Shelving

Periodical Display Shelves are 13"H with a 3/4"H retaining lip. The display shelves are adjustable on a pin and hole system but they do not tilt. Each sloping display shelf has a 13-3/4"H clear display area.

Note: Each metal display shelf receives 6 metal dividers per shelf.

48"H Omega Periodical Display Shelves

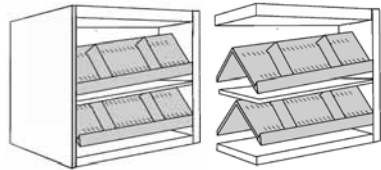

Oak Catalog No.	Maple Catalog No.	Description	H x W x D	Wt. (lbs.)	Oak Price	Maple Price
<u>2 Display Metal Shelves, 1 Adjustable Metal Shelf and 1 Wood Base Shelf per side</u>						
S7-925-S00	7S-925-S00	D/F Starter	48" x 37-3/16" x 24"	150	\$2,292	\$2,406
S8-925-S00	8S-925-S00	D/F Adder	48" x 36-3/16" x 24"	130	\$1,740	\$1,827

42"H Omega Periodical Display Shelves

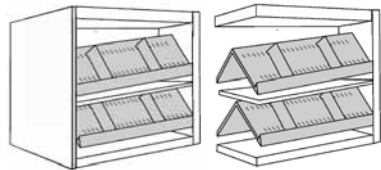

Oak Catalog No.	Maple Catalog No.	Description	H x W x D	Wt. (lbs.)	Oak Price	Maple Price
<u>2 Display Metal Shelves, 1 Adjustable Metal Shelf and 1 Wood Base Shelf per side</u>						
S7-924-S00	7S-924-S00	D/F Starter	42" x 37-3/16" x 12"	130	\$2,044	\$2,146
S8-924-S00	8S-924-S00	D/F Adder	42" x 36-3/16" x 12"	111	\$1,483	\$1,557

Please specify Wood Finish (Table 1) and Metal Color (Table 3). Details can be found on pages GEN 4 and GEN 5.

Note: Shelving Backs and Partitions are sold separately and are located in the Shelving Accessories Section on pages CLA 40 and CLA 41. Clip & Strip Shelving CANNOT be used with Omega Shelves.

Omega Tilt and Store Shelves, Single-Faced

Classic Shelving

Metal Tilt and Store Shelving

Sloping display shelves have a 13"H clear display area and lift up to expose flat storage shelves via a pivot hinge. Storage space is concealed when display shelves are in normal position.

Note: Tilt and Store Shelving is available in 16" depth ONLY.

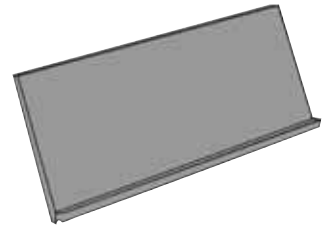

Oak Catalog No.	Maple Catalog No.	Description	H x W x D	Wt. (lbs.)	Oak Price	Maple Price
5 Tilting Metal Shelves, 4 Flat Wood Shelves and 1 Wood Base Shelf						
S7-935-S00	7S-935-S00	S/F Starter	82" x 37-3/16" x 16"	250	\$2,520	\$2,646
S8-935-S00	8S-935-S00	S/F Adder	82" x 36-3/16" x 16"	214	\$2,116	\$2,222

82"H Omega Tilt & Store Shelves

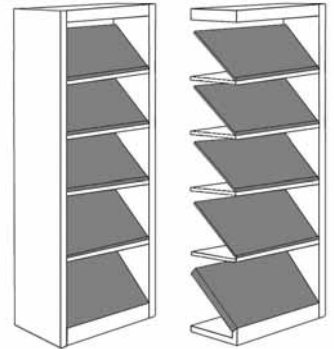

4 Tilting Metal Shelves, 3 Flat Wood Shelves and 1 Wood Base Shelf						
S7-880-S00	7S-880-S00	S/F Starter	72" x 37-3/16" x 16"	220	\$2,390	\$2,509
S8-880-S00	8S-880-S00	S/F Adder	72" x 36-3/16" x 16"	180	\$1,879	\$1,973

72"H Omega Tilt & Store Shelves

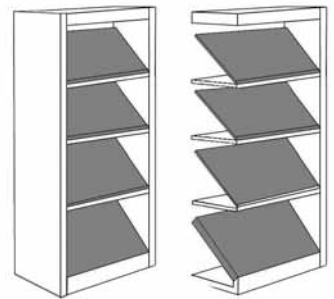

3 Tilting Metal Shelves, 2 Flat Wood Shelves and 1 Wood Base Shelf						
S7-936-S00	7S-936-S00	S/F Starter	60-1/2" x 37-3/16" x 16"	180	\$2,260	\$2,373
S8-936-S00	8S-936-S00	S/F Adder	60-1/2" x 36-3/16" x 16"	130	\$1,639	\$1,721

60-1/2"H Omega Tilt & Store Shelves

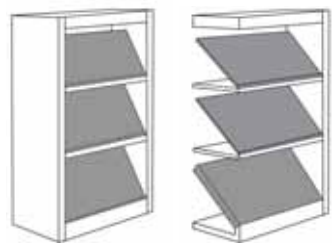

2 Tilting Metal Shelves, 1 Flat Wood Shelves and 1 Wood Base Shelf						
S7-938-S00	7S-938-S00	S/F Starter	48" x 37-3/16" x 16"	120	\$2,016	\$2,117
S8-938-S00	8S-938-S00	S/F Adder	48" x 36-3/16" x 16"	110	\$1,543	\$1,620

48"H Omega Tilt & Store Shelves

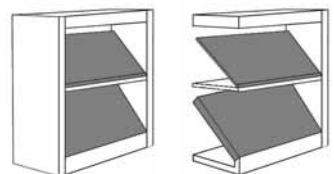

2 Tilting Metal Shelves, 1 Flat Wood Shelves and 1 Wood Base Shelf						
S7-937-S00	7S-937-S00	S/F Starter	42" x 37-3/16" x 16"	100	\$1,773	\$1,861
S8-937-S00	8S-937-S00	S/F Adder	42" x 36-3/16" x 16"	90	\$1,445	\$1,518

42"H Omega Tilt & Store Shelves

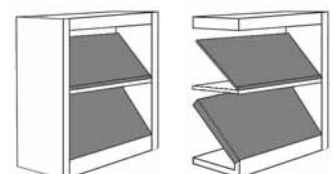

Please specify Wood Finish (Table 1) and Metal Color (Table 3).
Details can be found on pages GEN 4 and GEN 5.

Note: Shelving Backs and Partitions are sold separately and are located in the Shelving Accessories Section on pages CLA 40 and CLA 41.
Clip & Strip Shelving CANNOT be used with Omega Shelves.

Classic Shelving

Omega Tilt and Store Shelves, Double-Faced

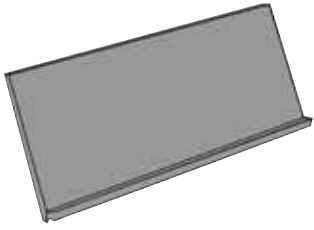

Metal Tilt and Store Shelving

Sloping display shelves have a 13"H clear display area and lift up to expose flat storage shelves via a pivot hinge. Storage space is concealed when display shelves are in normal position.

Note: Tilt and Store Shelving is available in 16" depth ONLY.

82"H Omega Tilt & Store Shelves

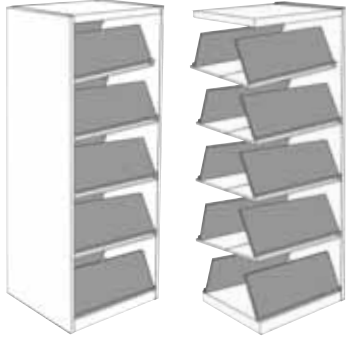

Oak Catalog No.	Maple Catalog No.	Description	H x W x D	Wt. (lbs.)	Oak Price	Maple Price
<i>5 Tilting Metal Shelves, 4 Flat Wood Shelves and 1 Wood Base Shelf per Side</i>						
S7-945-S00	7S-945-S00	D/F Starter	82" x 37-3/16" x 32"	450	\$4,535	\$4,763
S8-945-S00	8S-945-S00	D/F Adder	82" x 36-3/16" x 32"	385	\$3,810	\$3,999

72"H Omega Tilt & Store Shelves

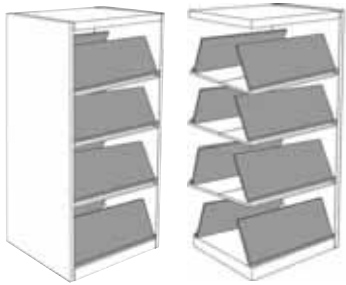

Oak Catalog No.	Maple Catalog No.	Description	H x W x D	Wt. (lbs.)	Oak Price	Maple Price
<i>4 Tilting Metal Shelves, 3 Flat Wood Shelves and 1 Wood Base Shelf per Side</i>						
S7-840-S00	7S-840-S00	D/F Starter	72" x 37-3/16" x 32"	396	\$4,303	\$4,517
S8-840-S00	8S-840-S00	D/F Adder	72" x 36-3/16" x 32"	324	\$3,381	\$3,551

60-1/2"H Omega Tilt & Store Shelves

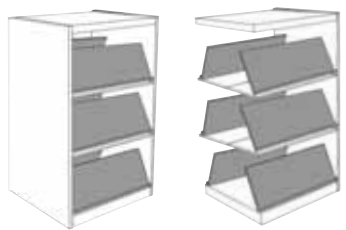

Oak Catalog No.	Maple Catalog No.	Description	H x W x D	Wt. (lbs.)	Oak Price	Maple Price
<i>3 Tilting Metal Shelves, 2 Flat Wood Shelves and 1 Wood Base Shelf per Side</i>						
S7-946-S00	7S-946-S00	D/F Starter	60-1/2" x 37-3/16" x 32"	324	\$4,068	\$4,271
S8-946-S00	8S-946-S00	D/F Adder	60-1/2" x 36-3/16" x 32"	234	\$2,950	\$3,098

48"H Omega Tilt & Store Shelves

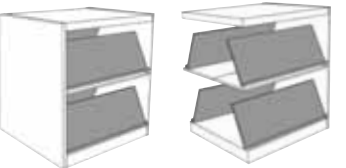

Oak Catalog No.	Maple Catalog No.	Description	H x W x D	Wt. (lbs.)	Oak Price	Maple Price
<i>2 Tilting Metal Shelves, 1 Flat Wood Shelves and 1 Wood Base Shelf per Side</i>						
S7-948-S00	7S-948-S00	D/F Starter	48" x 37-3/16" x 32"	216	\$3,629	\$3,810
S8-948-S00	8S-948-S00	D/F Adder	48" x 36-3/16" x 32"	198	\$2,777	\$2,916

42"H Omega Tilt & Store Shelves

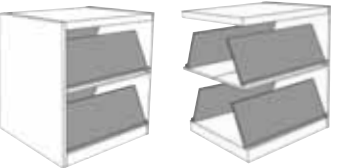

Oak Catalog No.	Maple Catalog No.	Description	H x W x D	Wt. (lbs.)	Oak Price	Maple Price
<i>2 Tilting Metal Shelves, 1 Flat Wood Shelves and 1 Wood Base Shelf per Side</i>						
S7-947-S00	7S-947-S00	D/F Starter	42" x 37-3/16" x 32"	180	\$3,190	\$3,351
S8-947-S00	8S-947-S00	D/F Adder	42" x 36-3/16" x 32"	162	\$2,602	\$2,732

Please specify Wood Finish (Table 1) and Metal Color (Table 3). Details can be found on pages GEN 4 and GEN 5.

Note: Shelving Backs and Partitions are sold separately and are located in the Shelving Accessories Section on pages CLA 40 and CLA 41.

Clip & Strip Shelving CANNOT be used with Omega Shelves.

Omega Picture Book Shelves, Single-Faced

Classic Shelving

Metal Picture Book Shelving

Metal Picture Book Shelves are 11"D x 7"H overall with two metal dividers per shelf. Dividers can be placed at 26 equal spaces along the width of each shelf. A steel cotter pin is provided with each divider to prevent removal.



Oak Catalog No.	Maple Catalog No.	Description	H x W x D	Wt. (lbs.)	Oak Price	Maple Price
-----------------	-------------------	-------------	-----------	------------	-----------	-------------

4 Adjustable (1 Fixed) Picture Book w/Divider Metal Shelves and 1 Wood Base Shelf

S1-233-S00	1S-233-S00	S/F Starter	82" x 37-3/16" x 12"	250	\$1,445	\$1,518
S2-233-S00	2S-233-S00	S/F Adder	82" x 36-3/16" x 12"	214	\$1,059	\$1,111

82"H Omega Picture Book Shelves

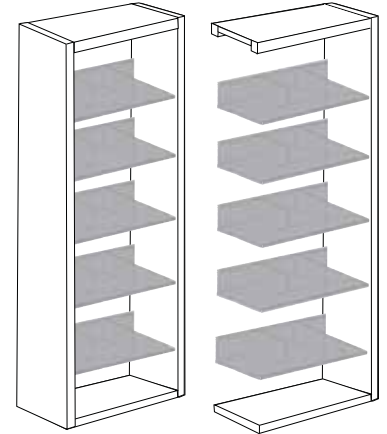

4 Adjustable Picture Book w/Divider Metal Shelves and 1 Wood Base Shelf

S1-237-S00	1S-237-S00	S/F Starter	72" x 37-3/16" x 12"	220	\$1,318	\$1,384
S2-237-S00	2S-237-S00	S/F Adder	72" x 36-3/16" x 12"	180	\$982	\$1,031

72"H Omega Picture Book Shelves

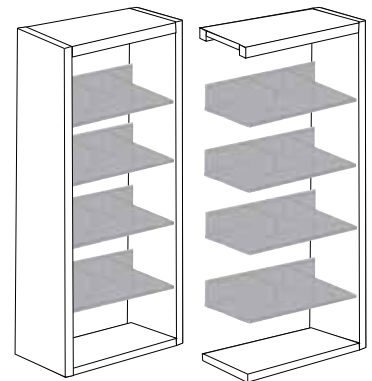

3 Adjustable Picture Book w/Divider Metal Shelves and 1 Wood Base Shelf

S1-232-S00	1S-232-S00	S/F Starter	60-1/2" x 37-3/16" x 12"	180	\$1,191	\$1,251
S2-232-S00	2S-232-S00	S/F Adder	60-1/2" x 36-3/16" x 12"	130	\$906	\$951

60-1/2"H Omega Picture Book Shelves

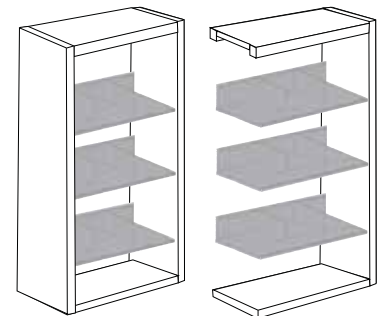

Please specify Wood Finish (Table 1) and Metal Color (Table 3). Details can be found on pages GEN 4 and GEN 5.

Note: Clip & Strip Shelving CANNOT be used with Omega Shelves. Shelving Backs and Partitions CANNOT be used with Omega Picture Book Shelving.



Metal Picture Book Shelving

Metal Picture Book Shelves are 11"D x 7"H overall with two metal dividers per shelf. Dividers can be placed at 26 equal spaces along the width of each shelf. A steel cotter pin is provided with each divider to prevent removal.

	Oak Catalog No.	Maple Catalog No.	Description	H x W x D	Wt. (lbs.)	Oak Price	Maple Price
48"H Omega Picture Book Shelves	<i>2 Adjustable Picture Book w/Divider Metal Shelves and 1 Wood Base Shelf</i>						
	S1-238-S00	1S-238-S00	S/F Starter	48" x 37-3/16" x 12"	120	\$971	\$1,020
	S2-238-S00	2S-238-S00	S/F Adder	48" x 36-3/16" x 12"	110	\$700	\$735

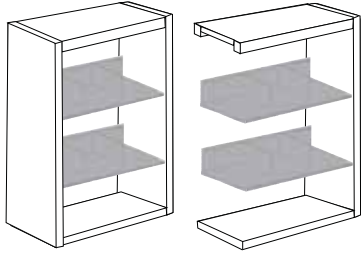

	Oak Catalog No.	Maple Catalog No.	Description	H x W x D	Wt. (lbs.)	Oak Price	Maple Price
42"H Omega Picture Book Shelves	<i>2 Adjustable Picture Book w/Divider Metal Shelves and 1 Wood Base Shelf</i>						
	S1-231-S00	1S-231-S00	S/F Starter	42" x 37-3/16" x 12"	100	\$914	\$959
	S2-231-S00	2S-231-S00	S/F Adder	42" x 36-3/16" x 12"	90	\$647	\$679

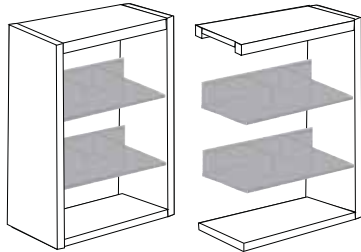

Please specify Wood Finish (Table 1) and Metal Color (Table 3). Details can be found on pages GEN 4 and GEN 5.

Note: Clip & Strip Shelving CANNOT be used with Omega Shelves. Shelving Backs and Partitions CANNOT be used with Omega Picture Book Shelving.

Omega Picture Book Shelves, Double-Faced

Classic Shelving

Metal Picture Book Shelving

Metal Picture Book Shelves are 11"D x 7"H overall with two metal dividers per shelf. Dividers can be placed at 26 equal spaces along the width of each shelf. A steel cotter pin is provided with each divider to prevent removal.



Oak Catalog No.	Maple Catalog No.	Description	H x W x D	Wt. (lbs.)	Oak Price	Maple Price
-----------------	-------------------	-------------	-----------	------------	-----------	-------------

4 Adjustable (1 Fixed) Picture Book w/Divider Metal Shelves and 1 Wood Base Shelf per Side

S1-236-S00	1S-236-S00	D/F Starter	82" x 37-3/16" x 24"	450	\$2,653	\$2,785
S2-236-S00	2S-236-S00	D/F Adder	82" x 36-3/16" x 24"	385	\$1,909	\$2,004

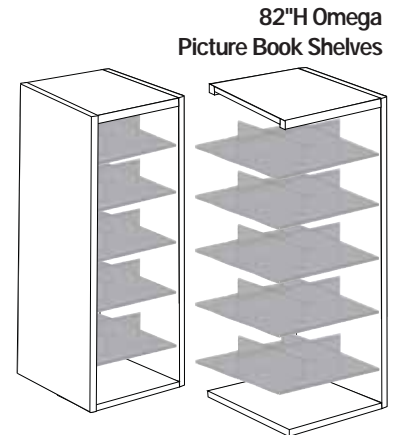

4 Adjustable Picture Book w/Divider Metal Shelves and 1 Wood Base Shelf per Side

S1-247-S00	1S-247-S00	D/F Starter	72" x 37-3/16" x 24"	396	\$2,475	\$2,599
S2-247-S00	2S-247-S00	D/F Adder	72" x 36-3/16" x 24"	324	\$1,846	\$1,939

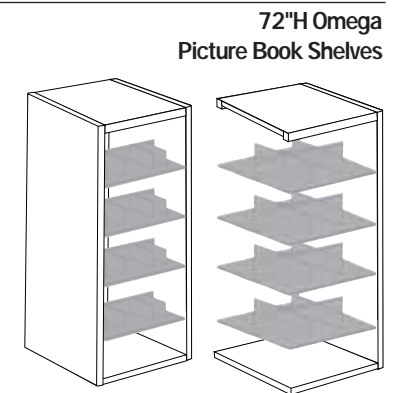

3 Adjustable Picture Book w/Divider Metal Shelves and 1 Wood Base Shelf per Side

S1-235-S00	1S-235-S00	D/F Starter	60-1/2" x 37-3/16" x 24"	324	\$2,297	\$2,411
S2-235-S00	2S-235-S00	D/F Adder	60-1/2" x 36-3/16" x 24"	234	\$1,782	\$1,871

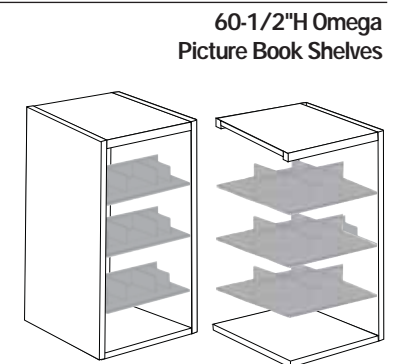

Please specify Wood Finish (Table 1) and Metal Color (Table 3). Details can be found on pages GEN 4 and GEN 5.

Note: Clip & Strip Shelving CANNOT be used with Omega Shelves. Shelving Backs and Partitions CANNOT be used with Omega Picture Book Shelving.



Metal Picture Book Shelving

Metal Picture Book Shelves are 11"D x 7"H overall with two metal dividers per shelf. Dividers can be placed at 26 equal spaces along the width of each shelf. A steel cotter pin is provided with each divider to prevent removal.

	Oak Catalog No.	Maple Catalog No.	Description	H x W x D	Wt. (lbs.)	Oak Price	Maple Price
<u>2 Adjustable Picture Book w/Divider Metal Shelves and 1 Wood Base Shelf per Side</u>							
48"H Omega Picture Book Shelves	S1-248-S00	1S-248-S00	D/F Starter	48" x 37-3/16" x 24"	216	\$1,730	\$1,817
	S2-248-S00	2S-248-S00	D/F Adder	48" x 36-3/16" x 24"	198	\$1,298	\$1,363

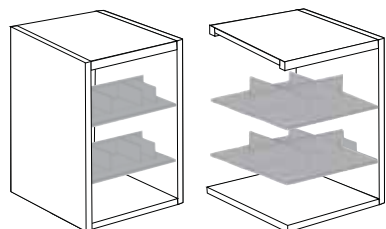

	Oak Catalog No.	Maple Catalog No.	Description	H x W x D	Wt. (lbs.)	Oak Price	Maple Price
<u>2 Adjustable Picture Book w/Divider Metal Shelves and 1 Wood Base Shelf per Side</u>							
42"H Omega Picture Book Shelves	S1-234-S00	1S-234-S00	D/F Starter	42" x 37-3/16" x 24"	180	\$1,587	\$1,667
	S2-234-S00	2S-234-S00	D/F Adder	42" x 36-3/16" x 24"	162	\$1,178	\$1,236

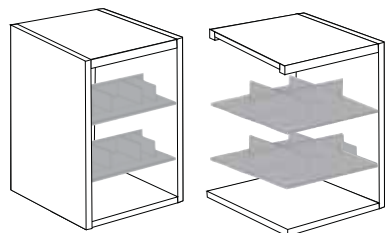

Please specify Wood Finish (Table 1) and Metal Color (Table 3). Details can be found on pages GEN 4 and GEN 5.

Note: Clip & Strip Shelving CANNOT be used with Omega Shelves. Shelving Backs and Partitions CANNOT be used with Omega Picture Book Shelving.

Casters Base



Oak Catalog No.	Maple Catalog No.	Description	H x W x D	Wt. (lbs.)	Oak Price	Maple Price
4 Adjustable Shelves and 1 Base Shelf per Side						
S1-985-S07	1S-985-S07	D/F Starter	60-1/2" x 37-3/16" x 20"	144	\$2,515	\$2,640
S1-985-S08	1S-985-S08	D/F Starter/Adder	60-1/2" x 73-3/8" x 20"	268	\$4,527	\$4,753
S1-986-S07	1S-986-S07	D/F Starter	60-1/2" x 37-3/16" x 24"	190	\$2,647	\$2,779
S1-986-S08	1S-986-S08	D/F Starter/Adder	60-1/2" x 73-3/8" x 24"	352	\$4,765	\$5,003

60-1/2"H Wood Shelves



2 Adjustable Shelves and 1 Base Shelf per Side						
S1-765-S07	1S-765-S07	D/F Starter	48" x 37-3/16" x 20"	117	\$1,983	\$2,081
S1-765-S08	1S-765-S08	D/F Starter/Adder	48" x 73-3/8" x 20"	217	\$3,570	\$3,749
S1-766-S07	1S-766-S07	D/F Starter	48" x 37-3/16" x 24"	154	\$2,086	\$2,191
S1-766-S08	1S-766-S08	D/F Starter/Adder	48" x 73-3/8" x 24"	285	\$3,758	\$3,946

48"H Wood Shelves

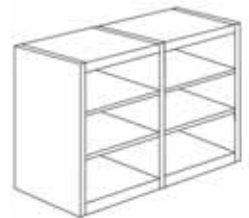

2 Adjustable Shelves and 1 Base Shelf per Side						
S1-987-S07	1S-987-S07	D/F Starter	42" x 37-3/16" x 20"	106	\$1,850	\$1,944
S1-987-S08	1S-987-S08	D/F Starter/Adder	42" x 73-3/8" x 20"	204	\$3,328	\$3,494
S1-991-S07	1S-991-S07	D/F Starter	42" x 37-3/16" x 24"	140	\$1,948	\$2,046
S1-991-S08	1S-991-S08	D/F Starter/Adder	42" x 73-3/8" x 24"	269	\$3,503	\$3,678

42"H Wood Shelves



Please specify Wood Finish (Table 1). Details can be found on page GEN 4.
 For details regarding Clip & Strip Shelving, Sub Tops or Individual HPL Tops, please reference the Modifications & Up Charges Section located on page MOD 8.

Note: Partitions included for Mobile Units.

Classic Shelving *Mobile Unit w/ Wood Periodical Display Shelves, Double-Faced*



Casters Base

	Oak Catalog No.	Maple Catalog No.	Description	H x W x D	Wt. (lbs.)	Oak Price	Maple Price
60-1/2"H Wood Periodical Display Shelves	<i>3 Sloping Shelves, 2 Flat Shelves and 1 Wood Base Shelf per Side</i>						
	S1-923-S07	1S-923-S07	D/F Starter	60-1/2" x 37-3/16" x 24"	190	\$3,891	\$4,085
	S1-923-S08	1S-923-S08	D/F Starter/Adder	60-1/2" x 73-3/8" x 24"	352	\$7,004	\$7,355

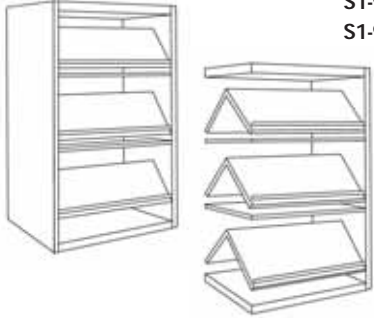

	Oak Catalog No.	Maple Catalog No.	Description	H x W x D	Wt. (lbs.)	Oak Price	Maple Price
48"H Wood Periodical Display Shelves	<i>2 Sloping Shelves, 1 Flat Shelves and 1 Wood Base Shelf per Side</i>						
	S1-925-S07	1S-925-S07	D/F Starter	48" x 37-3/16" x 24"	154	\$3,067	\$3,220
	S1-925-S08	1S-925-S08	D/F Starter/Adder	48" x 73-3/8" x 24"	285	\$5,524	\$5,801

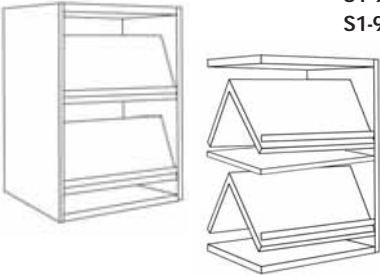

	Oak Catalog No.	Maple Catalog No.	Description	H x W x D	Wt. (lbs.)	Oak Price	Maple Price
42"H Wood Periodical Display Shelves	<i>2 Sloping Shelves, 1 Flat Shelves and 1 Wood Base Shelf per Side</i>						
	S1-924-S07	1S-924-S07	D/F Starter	42" x 37-3/16" x 24"	140	\$2,864	\$3,007
	S1-924-S08	1S-924-S08	D/F Starter/Adder	42" x 73-3/8" x 24"	269	\$5,149	\$5,407

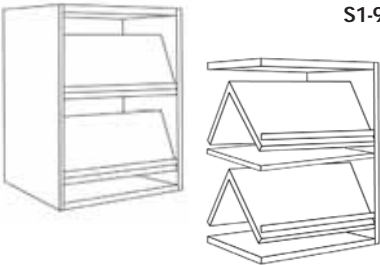

Please specify Wood Finish (Table 1). Details can be found on page GEN 4.

For details regarding Clip & Strip Shelving, Sub Tops or Individual HPL Tops, please reference the Modifications & Up Charges Section located on page MOD 8.

Note: Partitions included for Mobile Units.

Casters Base



Oak Catalog No.	Maple Catalog No.	Description	H x W x D	Wt. (lbs.)	Oak Price	Maple Price
2 Adjustable Picture Book w/Divider Shelves and 1 Base Shelf per Side						
S1-933-S07	1S-933-S07	D/F Starter	60-1/2" x 37-3/16" x 24"	190	\$2,779	\$2,918
S1-933-S08	1S-933-S08	D/F Starter/Adder	60-1/2" x 73-3/8" x 24"	352	\$4,901	\$5,145

60-1/2"H Wood Picture Book Shelves

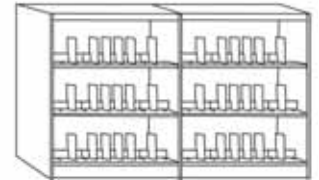

1 Adjustable Picture Book w/Divider Shelves and 1 Base Shelf per Side						
S1-930-S07	1S-930-S07	D/F Starter	48" x 37-3/16" x 24"	154	\$2,252	\$2,365
S1-930-S08	1S-930-S08	D/F Starter/Adder	48" x 73-3/8" x 24"	285	\$4,051	\$4,253

48"H Wood Picture Book Shelves

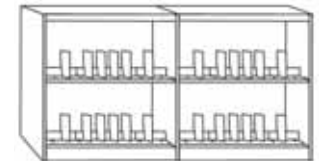

1 Adjustable Picture Book w/Divider Shelves and 1 Base Shelf per Side						
S1-934-S07	1S-934-S07	D/F Starter	42" x 37-3/16" x 24"	140	\$2,056	\$2,158
S1-934-S08	1S-934-S08	D/F Starter/Adder	42" x 73-3/8" x 24"	269	\$3,780	\$3,969

42"H Wood Picture Book Shelves

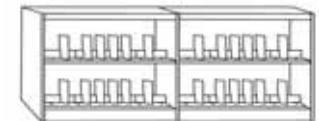

Please specify Wood Finish (Table 1). Details can be found on page GEN 4.
 For details regarding Clip & Strip Shelving, Sub Tops or Individual HPL Tops, please reference the Modifications & Up Charges Section located on page MOD 8.

Note: Partitions included for Mobile Units.



Casters Base

	Oak Catalog No.	Maple Catalog No.	Description	H x W x D	Wt. (lbs.)	Oak Price	Maple Price
60-1/2"H Omega Shelves	<i>4 Adjustable Metal Shelves and 1 Wood Base Shelf per Side</i>						
	S5-985-S07	5S-985-S07	D/F Starter	60-1/2" x 37-3/16" x 20"	144	\$2,462	\$2,585
	S5-985-S08	5S-985-S08	D/F Starter/Adder	60-1/2" x 73-3/8" x 20"	268	\$4,432	\$4,653
	S5-986-S07	5S-986-S07	D/F Starter	60-1/2" x 37-3/16" x 24"	190	\$2,513	\$2,639
	S5-986-S08	5S-986-S08	D/F Starter/Adder	60-1/2" x 73-3/8" x 24"	352	\$4,523	\$4,749

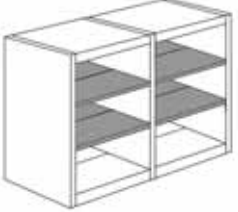
48"H Omega Shelves	<i>2 Adjustable Metal Shelves and 1 Wood Base Shelf per Side</i>						
	S5-765-S07	5S-765-S07	D/F Starter	48" x 37-3/16" x 20"	117	\$1,942	\$2,039
	S5-765-S08	5S-765-S08	D/F Starter/Adder	48" x 73-3/8" x 20"	217	\$3,496	\$3,671
	S5-766-S07	5S-766-S07	D/F Starter	48" x 37-3/16" x 24"	154	\$1,980	\$2,079
	S5-766-S08	5S-766-S08	D/F Starter/Adder	48" x 73-3/8" x 24"	285	\$3,567	\$3,746

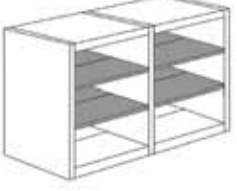
42"H Omega Shelves	<i>2 Adjustable Metal Shelves and 1 Wood Base Shelf per Side</i>						
	S5-987-S07	5S-987-S07	D/F Starter	42" x 37-3/16" x 20"	106	\$1,812	\$1,902
	S5-987-S08	5S-987-S08	D/F Starter/Adder	42" x 73-3/8" x 20"	204	\$3,259	\$3,422
	S5-991-S07	5S-991-S07	D/F Starter	42" x 37-3/16" x 24"	140	\$1,849	\$1,942
	S5-991-S08	5S-991-S08	D/F Starter/Adder	42" x 73-3/8" x 24"	269	\$3,325	\$3,492

Please specify Wood Finish (Table 1) and Metal Color (Table 3). Details can be found on pages GEN 4 and GEN 5.

Note: Clip & Strip Shelving CANNOT be used with Omega Shelves. Partitions included for Mobile Units.

Casters Base



Oak Catalog No.	Maple Catalog No.	Description	H x W x D	Wt. (lbs.)	Oak Price	Maple Price
4 Adjustable Metal Shelves and 1 Metal Base Shelf per Side						
S7-985-S07	7S-985-S07	D/F Starter	60-1/2" x 37-3/16" x 20"	144	\$3,012	\$3,163
S7-985-S08	7S-985-S08	D/F Starter/Adder	60-1/2" x 73-3/8" x 20"	268	\$5,291	\$5,555
S7-986-S07	7S-986-S07	D/F Starter	60-1/2" x 37-3/16" x 24"	190	\$3,085	\$3,240
S7-986-S08	7S-986-S08	D/F Starter/Adder	60-1/2" x 73-3/8" x 24"	352	\$5,381	\$5,650

60-1/2"H Omega Book Stop Shelves



2 Adjustable Metal Shelves and 1 Metal Base Shelf per Side						
S7-765-S07	7S-765-S07	D/F Starter	48" x 37-3/16" x 20"	117	\$2,216	\$2,327
S7-765-S08	7S-765-S08	D/F Starter/Adder	48" x 73-3/8" x 20"	217	\$3,822	\$4,014
S7-766-S07	7S-766-S07	D/F Starter	48" x 37-3/16" x 24"	154	\$2,334	\$2,451
S7-766-S08	7S-766-S08	D/F Starter/Adder	48" x 73-3/8" x 24"	285	\$4,024	\$4,225

48"H Omega Book Stop Shelves

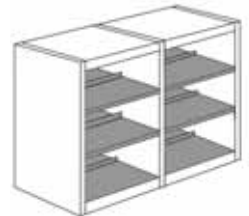

2 Adjustable Metal Shelves and 1 Metal Base Shelf per Side						
S7-987-S07	7S-987-S07	D/F Starter	42" x 37-3/16" x 20"	106	\$1,996	\$2,096
S7-987-S08	7S-987-S08	D/F Starter/Adder	42" x 73-3/8" x 20"	204	\$3,577	\$3,756
S7-991-S07	7S-991-S07	D/F Starter	42" x 37-3/16" x 24"	140	\$2,101	\$2,206
S7-991-S08	7S-991-S08	D/F Starter/Adder	42" x 73-3/8" x 24"	269	\$3,766	\$3,954

(42"H Omega Book Stop Shelves

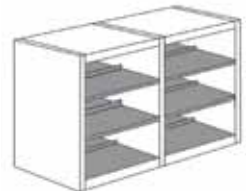



Please specify Wood Finish (Table 1) and Metal Color (Table 3). Details can be found on pages GEN 4 and GEN 5.

Note: Clip & Strip Shelving CANNOT be used with Omega Shelves. Shelving Backs and Partitions CANNOT be used with Omega Book Stop Shelving. Sway Braces included.

Shelving Backs

Except where specified, all single-faced shelving is supplied without backs. When specified, single-faced shelving is supplied with full-height and full width plywood backs, 1/4" thick. Backs Partitions fit into rabbets in the end panels, intermediates, tops, and base, so that edges are concealed from view after installation.

	Oak Catalog No.	Maple Catalog No.	Description	H x W x D	Wt. (lbs.)	Oak Price	Maple Price
Plywood with Veneer Face Single-Faced Shelving Backs 	SB-608-S00	BS-608-S00	S/F Back, 90"H	87-5/16" x 35-5/8" x 1/4"	24	\$182	\$191
	SB-600-S00	BS-600-S00	S/F Back, 82"H	79-5/16" x 35-5/8" x 1/4"	22	\$176	\$184
	SB-620-S00	BS-620-S00	S/F Back, 72"H	69-5/16" x 35-5/8" x 1/4"	20	\$173	\$181
	SB-602-S00	BS-602-S00	S/F Back, 60-1/2"H	58-15/16" x 35-5/8" x 1/4"	18	\$169	\$177
	SB-606-S00	BS-606-S00	S/F Back, 48"H	46-7/16" x 35-5/8" x 1/4"	15	\$117	\$123
	SB-604-S00	BS-604-S00	S/F Back, 42"H	40-7/16" x 35-5/8" x 1/4"	12	\$105	\$110

	Oak Catalog No.	Maple Catalog No.	Description	H x W x D	Wt. (lbs.)	Oak Price	Maple Price
Finished Two Sides Plywood with Veneer Face Single-Faced Shelving Backs 	SB-608-S02	BS-608-S02	S/F Back, 90"H	87-5/16" x 35-5/8" x 1/4"	24	\$238	\$250
	SB-600-S02	BS-600-S02	S/F Back, 82"H	79-5/16" x 35-5/8" x 1/4"	22	\$230	\$242
	SB-620-S02	BS-620-S02	S/F Back, 72"H	69-5/16" x 35-5/8" x 1/4"	20	\$214	\$225
	SB-602-S02	BS-602-S02	S/F Back, 60-1/2"H	58-15/16" x 35-5/8" x 1/4"	18	\$198	\$208
	SB-606-S02	BS-606-S02	S/F Back, 48"H	46-7/16" x 35-5/8" x 1/4"	15	\$146	\$153
	SB-604-S02	BS-604-S02	S/F Back, 42"H	40-7/16" x 35-5/8" x 1/4"	12	\$134	\$141

Note: For use with shelving with exposed backs. (Does not include finishing and banding back edge of shelving unit.)

	Oak Catalog No.	Maple Catalog No.	Description	H x W x D	Wt. (lbs.)	Oak Price	Maple Price
Painted Single-Faced Shelving Backs 	SB-940-S00	N/A	S/F Back, 90"H	87-5/16" x 35-5/8" x 1/4"	24	\$150	N/A
	SB-939-S00	N/A	S/F Back, 82"H	79-5/16" x 35-5/8" x 1/4"	22	\$144	N/A
	SB-960-S00	N/A	S/F Back, 72"H	69-5/16" x 35-5/8" x 1/4"	20	\$141	N/A
	SB-942-S00	N/A	S/F Back, 60-1/2"H	58-15/16" x 35-5/8" x 1/4"	18	\$139	N/A
	SB-948-S00	N/A	S/F Back, 48"H	46-7/16" x 35-5/8" x 1/4"	15	\$96	N/A
	SB-943-S00	N/A	S/F Back, 42"H	40-7/16" x 35-5/8" x 1/4"	12	\$83	N/A





Please specify Wood Finish (Table 1) or Paint Color; if applicable (Table 3). Details can be found on pages GEN 4 and GEN 5.

Shelving Partitions

Except where specified, all double-faced shelving is supplied without partitions. When specified, double-faced shelving is supplied with full-height and full width plywood partitions, 1/4" thick. Partitions fit into rabbets in the end panels, intermediates, tops, and base, so that edges are concealed from view after installation.

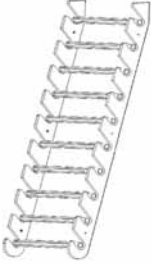
Oak Catalog No.	Maple Catalog No.	Description	H x W x D	Wt. (lbs.)	Oak Price	Maple Price	
SB-609-S00	BS-609-S00	D/F Partition, 90"H	87-5/16" x 35-5/8" x 1/4"	24	\$238	\$250	Plywood with Veneer Face Double-Faced Shelving Partitions 
SB-601-S00	BS-601-S00	D/F Partition, 82"H	79-5/16" x 35-5/8" x 1/4"	22	\$230	\$242	
SB-621-S00	BS-621-S00	D/F Partition, 72"H	69-5/16" x 35-5/8" x 1/4"	20	\$214	\$225	
SB-603-S00	BS-603-S00	D/F Partition, 60-1/2"H	58-15/16" x 35-5/8" x 1/4"	18	\$198	\$208	
SB-607-S00	BS-607-S00	D/F Partition, 48"H	46-7/16" x 35-5/8" x 1/4"	15	\$146	\$153	
SB-605-S00	BS-605-S00	D/F Partition, 42"H	40-7/16" x 35-5/8" x 1/4"	12	\$134	\$141	

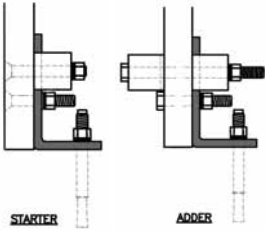

SB-941-S00	N/A	D/F Partition, 90"H	87-5/16" x 35-5/8" x 1/4"	24	\$177	N/A	Painted Double-Faced Shelving Partitions 
SB-945-S00	N/A	D/F Partition, 82"H	79-5/16" x 35-5/8" x 1/4"	22	\$169	N/A	
SB-961-S00	N/A	D/F Partition, 72"H	69-5/16" x 35-5/8" x 1/4"	20	\$159	N/A	
SB-947-S00	N/A	D/F Partition, 60-1/2"H	58-15/16" x 35-5/8" x 1/4"	18	\$146	N/A	
SB-950-S00	N/A	D/F Partition, 48"H	46-7/16" x 35-5/8" x 1/4"	15	\$109	N/A	
SB-949-S00	N/A	D/F Partition, 42"H	40-7/16" x 35-5/8" x 1/4"	12	\$102	N/A	

	Oak Catalog No.	Maple Catalog No.	Description	H x W x D	Wt. (lbs.)	Oak Price	Maple Price
 <p>Newspaper File Insert</p>	S1-968-S00	1S-968-S00	<p>Newspaper File Insert</p> <p>Unit fits into any 10" or 12"D shelving unit 60-1/2"H or higher. File insert is made of two (2) hardwood rails, 1" thick, with ten (10) slots for files. Cleats are attached to uprights with wood screws. Insert is supplied with ten (10) newspaper sticks.</p>	40-3/4" x 35-3/16"	20	\$701	\$735
 <p>Bulletin Board Insert</p>	S1-862-S00	1S-862-S00	<p>Bulletin Board Insert</p> <p>Unit is of solid hardwood frame construction. Frame rails are 1-3/4"W. Inserted into the inside edge of the frame is a 1/2" thick cork board. A metal piano hinge is attached to the rear top of the frame that is to be screwed to the shelving top fascia. This allows the bulletin board to lift for storage. A metal pull knob is affixed to the center of the bottom frame rail and two (2) magnetic catches secure the unit when closed.</p>	21-3/8" x 35-1/16"	20	\$492	\$517
 <p>Pullout Reference Shelf</p>	S6-120-S00 OAK	S6-120-S00 MAP	<p>Pullout Reference Shelf</p> <p>Shelf and shelf front is constructed of 3/4" 7-ply hardwood plywood. Shelf front receives two black wire drawer pulls. The shelf receives a set of solid hardwood cleats 1-1/4" x 1-1/4" for mounting to shelving unit and 100 # full extension drawer slides.</p>	3-3/4" x 35-1/8" x 11-1/4"	20	\$597	\$627
 <p>Pullout CD DVD Shelf</p>	S6-122-S00 OAK	S6-122-S00 MAP	<p>Pullout CD/DVD Shelf</p> <p>Drawer is constructed of solid hardwood with 1/4" thick wood panel bottom. Drawer has 7-ply hardwood plywood fronts with select face veneers and two (2) black wire drawer pulls. Drawer receives a set of solid hardwood cleats 1-1/4" x 1-1/4" for mounting to shelving unit and 100 # full extension drawer slides. Each unit contains five (5) storage compartments for CD/DVD storage. Each compartment is 4-3/4"H x 4-3/4"W x 9-1/2"D. Storage capacity is 21 CD jewel cases or 16 DVD cases per compartment.</p>	6-1/4" x 35-1/8" x 11-1/4"	30	\$843	\$885
<p>Seismic Anchors</p>  <p>EQSFSTART N/A</p> <p>EQSFADD N/A</p> <p>EQDFSTART N/A</p> <p>EQDFADD N/A</p>			<p>Seismic Anchors</p> <p>When specified, seismic anchoring will be provided for shelving of all heights and depths. Each panel in the shelving range will be required to receive seismic anchor hardware. Seismic anchoring consist of one (1) 1/4" thick 10-gauge hot rolled steel angle bracket, two (2) flathead socket cap bolts, two (2) flat washers, two (2) lock washers, two (2) hex nuts and one (1) Hilti bolt 3/8" x 3-3/4" with flat washer, lock washer and hex nut.</p>				
<p>Shelf Pins</p>	73-009-001	N/A	Pack of Shelf Pins - 4 per Pack			\$1	N/A

Please specify Wood Finish (Table 1) or Metal Color; if applicable (Table 3). Details can be found on pages GEN 4 and GEN 5.

Oak Catalog No.	Maple Catalog No.	Description	Wt. (lbs.)	Oak Price	Maple Price
<p>Wood shelves are 3/4" thick, glued-up solid Northern-grown Oak or Maple hardwood. Random widths no more than 4" or less than 1-1/2" are used. To ensure adequate support for heavy volumes, no substitute for solid hardwood is permitted. Adjustable shelves are grooved 11/32" diameter half round on the underside to set firmly on 1" long, 5/16" diameter threaded shelf pins, cadmium-plated. Shelf depths are nominal.</p> <p>Note: Double-Faced shelving you must order one base shelf per side of unit.</p>					
					Wood Shelves/Base Shelf
					
PSO-AW16-S	PMS-AW16-S	16" Shelf Wood	8	\$92	\$97
60-061-S00 OAK	60-061-S00 MAP	12" Shelf Wood	8	\$77	\$81
60-060-S00 OAK	60-060-S00 MAP	10" Shelf Wood	7	\$72	\$76
60-965-S00 OAK	60-965-S00 MAP	Sloping Wood Periodical Shelf	9	\$195	\$205
60-062-S00 OAK	60-062-S00 MAP	12" Picture Book Shelf with Hardboard Dividers	21	\$155	\$163
6096711	N/A	Hardboard Dividers for Picture Book Shelves (per divider)	1	\$6	N/A
SHPICBKS00 OAK	SHPICBKS00 MAP	12" Picture Book Shelf with Six 7-3/4"H x 3/4" Wood Dividers	25	\$366	\$384
1836382 OAK	1836382 MAP	S/F 16" Base Shelf	10	\$102	\$107
1836392 OAK	1836392 MAP	S/F 12" Base Shelf	9	\$89	\$94
1836402 OAK	1836402 MAP	S/F 10" Base Shelf	8	\$82	\$86
D1836382 OAK	D1836382 MAP	D/F 16" Base Shelf*	10	\$102	\$107
DH836392 OAK	D836392 MAP	D/F 12" Base Shelf*	9	\$89	\$94
DH836402 OAK	D836402 MAP	D/F 10" Base Shelf*	8	\$82	\$86
*Double-Faced shelving you must order one base shelf per side of unit.					
6096795 OAK	6096795 MAP	S/F 12" Picture Book Base Shelf	21	\$186	\$195
6096790 OAK	6096790 MAP	D/F 12" Picture Book Base Shelf*	21	\$173	\$181
*Double-Faced shelving you must order one base shelf per side of unit.					
Note: Dividers must be ordered separately.					
1836397 OAK	1836397 MAP	S/F 12" Glass Door Base Shelf	9	\$173	\$181

Please specify Wood Finish (Table 1). Details can be found on page GEN 4.

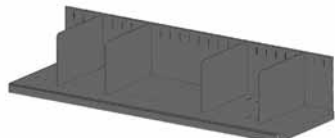
	Catalog No.	Description	H x W	Wt. (lbs.)	Price
	73-004-S00	12" Omega Flat Shelf		8	\$64
	73-003-S00	10" Omega Flat Shelf		7	\$60
		<p>Omega (steel) shelves are designed to fit Brodart's wood shelving units. These shelves are 18-gauge steel stamped with notches in the bottom edge to fit over shelf pins. The front and back edges are triple bent for strength and to eliminate sharp edges. Shelves are electrostatic powder-coat painted with epoxy paint and oven cured. Shelf accepts spring-type overhead wire book support. Omega shelves are available in many standard and optional colors - please call for selection.</p>			
	73-002-S00	12" Omega Book Stop Shelf		9	\$100
	73-001-S00	10" Omega Book Stop Shelf		8	\$93
		<p>Omega "Book Stop" steel shelves are designed to fit Brodart's wood shelving units. These shelves are 18-gauge steel stamped with notches in the bottom edge to fit over shelf pins. The front and back edges are triple bent for strength and to eliminate sharp edges. The back edge of the shelf is bent upward to form a 90° angle, 1-5/8" H above the shelf surface to function as a book stop. Shelves are electrostatic powder-coat painted with epoxy paint and oven cured. Units are supplied with a metal base shelf. Omega shelves are available in many standard and optional colors - please call for selection.</p>			
	S6-102-S00	Metal Media Display Shelf with 6 Dividers. Shelves are made to fit any standard 36"W wood shelving unit - pin and hole or clip & strip. Units are 18-gauge steel and are electrostatically powder painted with epoxy paint which is oven cured. The shelf can be divided with six (6) metal dividers which are provided with each shelf.	11" x 35"	20	\$219
	S6-103-S00	Metal Divider/Picture Book Shelf with 2 Dividers. Shelves are made to fit 36"W x 12"D wood shelving unit - pin and hole only. Units are 18-gauge steel, 10-1/2"D with a 7"H book-stop back and are electrostatically powder painted with epoxy paint which is oven cured. The shelf can be divided with two (2) metal dividers which are provided with each shelf and can be spaced at 1-1/4" intervals.	11" x 35"	20	\$173

Please specify Metal Color (Table 3). Details can be found on page GEN 5.

Note: Metal Divider/Picture Book Shelf CANNOT be used as a Base Shelf.

Oak Catalog No.	Maple Catalog No.	Description	Wt. (lbs.)	Oak Price	Maple Price
<i>Shelving Tops (Please specify shelving height that top is to be used on.)</i>					
1836311	1836311A	High 12" Top	9	\$243	\$255
1836321	1836321A	High 10" Top	8	\$225	\$236
1836281	1836281A	High 20" Top	15	\$338	\$355
1836271	1836271A	High 24" Top	17	\$365	\$383
1836312	1836312A	Low 12" Top	9	\$243	\$255
1836322	1836322A	Low 10" Top	8	\$225	\$236
1836282	1836282A	Low 20" Top	15	\$338	\$355
1836272	1836272A	Low 24" Top	17	\$365	\$383
<i>Shelving Base</i>					
1836341	1836341A	16" Base	7	\$200	\$210
1836351	1836351A	12" Base	6	\$159	\$167
1836361	1836361A	10" Base	6	\$144	\$151
<i>Shelving Slatwall End Panels</i>					
60-040-S00 OAK	60-040-S00 MAP	42"H x 20"D x 1"	40	\$580	\$609
60-041-S00 OAK	60-041-S00 MAP	42"H x 24"D x 1"	45	\$587	\$617
60-098-S00 OAK	60-098-S00 MAP	48"H x 20"D x 1"	45	\$599	\$629
60-099-S00 OAK	60-099-S00 MAP	48"H x 24"D x 1"	50	\$609	\$640
60-042-S00 OAK	60-042-S00 MAP	60-1/2"H x 20"D x 1"	55	\$763	\$801
60-043-S00 OAK	60-043-S00 MAP	60-1/2"H x 24"D x 1"	65	\$783	\$822
60-096-S00 OAK	60-096-S00 MAP	72"H x 20"D x 1"	65	\$816	\$857
60-097-S00 OAK	60-097-S00 MAP	72"H x 24"D x 1"	75	\$837	\$879
60-044-S00 OAK	60-044-S00 MAP	82"H x 20"D x 1"	70	\$870	\$914
60-045-S00 OAK	60-045-S00 MAP	82"H x 24"D x 1"	80	\$889	\$933
60-046-S00 OAK	60-046-S00 MAP	90"H x 20"D x 1"	80	\$931	\$977
60-047-S00 OAK	60-047-S00 MAP	90"H x 24"D x 1"	90	\$950	\$998

Please specify Wood Finish (Table 1). Details can be found on page GEN 4.

Note: Slatwall End Panels are designed to be used in conjunction with existing end panels.
Please use as an "ADD ON" feature only. Attaching hardware NOT INCLUDED.

Oak Catalog No.	Maple Catalog No.	Description	Wt. (lbs.)	Oak Price	Maple Price
<i>Shelving End Panels, Pin and Hole</i>					
2900210	2900210A	S/F 82"H x 12"D, Left	17	\$350	\$368
2900211	2900211A	S/F 82"H x 12"D, Right	17	\$350	\$368
2900212	2900212A	S/F 82"H x 10"D, Left	15	\$321	\$338
2900213	2900213A	S/F 82"H x 10"D, Right	15	\$321	\$338
2900203	2900203A	D/F 82"H x 24"D	33	\$598	\$628
2900202	2900202A	D/F 82"H x 20"D	21	\$569	\$598
2900201	2900201A	D/F 82"H x 16"D	23	\$539	\$566
2900274	2900274A	S/F 72"H x 12"D, Left	15	\$336	\$353
2900275	2900275A	S/F 72"H x 12"D, Right	15	\$336	\$353
2900276	2900276A	S/F 72"H x 10"D, Left	13	\$289	\$303
2900277	2900277A	S/F 72"H x 10"D, Right	13	\$289	\$303
2900281	2900281A	D/F 72"H x 24"D	29	\$549	\$576
2900280	2900280A	D/F 72"H x 20"D	20	\$214	\$225
2900218	2900218A	S/F 60-1/2"H x 12"D, Left	13	\$269	\$282
2900219	2900219A	S/F 60-1/2"H x 12"D, Right	13	\$269	\$282
2900220	2900220A	S/F 60-1/2"H x 10"D, Left	11	\$256	\$269
2900221	2900221A	S/F 60-1/2"H x 10"D, Right	11	\$256	\$269
2900206	2900206A	D/F 60-1/2"H x 24"D	25	\$454	\$477
2900205	2900206A	D/F 60-1/2"H x 20"D	21	\$413	\$433
2900251	2900251A	S/F 48"H x 12"D, Left	12	\$219	\$230
2900252	2900252A	S/F 48"H x 12"D, Right	12	\$219	\$230
2900253	2900253A	S/F 48"H x 10"D, Left	10	\$204	\$215
2900254	2900254A	S/F 48"H x 10"D, Right	10	\$204	\$215
2900250	2900250A	D/F 48"H x 24"D	21	\$355	\$373
2900249	2900249A	D/F 48"H x 20"D	19	\$329	\$346
2900226	2900226A	S/F 42"H x 12"D, Left	10	\$198	\$208
2900227	2900227A	S/F 42"H x 12"D, Right	10	\$198	\$208
2900228	2900228A	S/F 42"H x 10"D, Left	9	\$183	\$192
2900229	2900229A	S/F 42"H x 10"D, Right	9	\$183	\$192
2900209	2900209A	D/F 42"H x 24"D	18	\$309	\$324
2900208	2900208A	D/F 42"H x 20"D	17	\$291	\$305

Please specify Wood Finish (Table 1). Details can be found on page GEN 4.

Note: All End and Intermediate Panels are drilled and/or bushed for use with Brodart Shelving Only..

Oak Catalog No.	Maple Catalog No.	Description	Wt. (lbs.)	Oak Price	Maple Price
<i>Shelving Intermediate Panels, Pin and Hole</i>					
1836051	1836051A	S/F 82"H x 12"D	17	\$360	\$378
1836071	1836071A	S/F 82"H x 10"D	14	\$328	\$345
1835851	1835851A	D/F 82"H x 24"D	33	\$627	\$658
1835871	1835871A	D/F 82"H x 20"D	27	\$598	\$628
1836054	1836054A	S/F 72"H x 12"D	16	\$353	\$371
1836053	1836053A	S/F 72"H x 10"D	14	\$304	\$319
1835831	1835831A	D/F 72"H x 24"D	31	\$575	\$604
1835841	1835841A	D/F 72"H x 20"D	26	\$548	\$575
1836131	1836131A	S/F 60-1/2"H x 12"D	15	\$277	\$291
1836151	1836151A	S/F 60-1/2"H x 10"D	13	\$264	\$277
1835911	1835911A	D/F 60-1/2"H x 24"D	29	\$468	\$492
1835931	1835931A	D/F 60-1/2"H x 20"D	25	\$425	\$446
1836133	1836133A	S/F 48"H x 12"D	12	\$226	\$238
1836134	1836134A	S/F 48"H x 10"D	11	\$211	\$222
1835933	1835933A	D/F 48"H x 24"D	24	\$367	\$385
1835932	1835932A	D/F 48"H x 20"D	21	\$341	\$358
1836211	1836211A	S/F 42"H x 12"D	10	\$203	\$214
1836231	1836231A	S/F 42"H x 10"D	9	\$187	\$196
1835971	1835971A	D/F 42"H x 24"D	19	\$317	\$333
1835991	1835991A	D/F 42"H x 20"D	17	\$304	\$319

Please specify Wood Finish (Table 1). Details can be found on page GEN 4.

Note: All End and Intermediate Panels are drilled and/or bushed for use with Brodart Shelving Only.

Reprise Shelving



2017 Price List and Specifications

Brodart Co. Contract Furniture - Made in USA

280 North Road, Clinton County Industrial Park • McElhattan, PA 17748

Toll-Free: 888-521-1884 • E-Mail: furniture@brodart.com • www.brodartfurniture.com

General Specifications

CONSTRUCTION

Shelving construction is modular type, utilizing thermally-fused laminate panels. Shelving units are designed with the starter and adder concept and measure 36" from center to center of the uprights. Bannister Oak, Biltmore Cherry, Classic Maple, Canadian Gray, Classic Black and Bright White are the standard finishes for Reprise shelving uprights, tops and bases. Shelves are available in Orange, Red, Plum, Island Green and Lapis Blue in addition to the colors listed previously.

END PANELS

End panels are 1" thick thermally-fused laminate panels. All exposed vertical and top edges are banded with matching 2mm PVC edge banding. Edges are square, but eased. Vertical rows of holes are drilled near the front and rear of each panel for shelf adjustment on 32mm centers. Panels are drilled at front, rear, top, and bottom for embedding internal and external threaded bushings. Tops and bases are attached to end panels with 5/16" - 18 x 2" hex-head bolts and washers. Lag bolts or Laminate screws are not used. Clip and metal strip style shelf attachments are available if specified.

INTERMEDIATE UPRIGHTS

Intermediate uprights are 1" thick thermally-fused laminate panels. All exposed vertical and top edges are banded with matching 2mm PVC edge banding. Edges are square, but eased. Shelf pinholes are bored on both sides of the panel but staggered so that pins can be deeply seated. Panels are drilled through at front, rear, top, and bottom for attachment of tops and bases with 5/16" - 18 x 4-1/2" hex-head bolts, nuts, and washers. Clip and metal strip style shelf attachments are available if specified.

BASE

The base front is 4"H x 3/4" thick thermally-fused laminate panel with matching 2mm PVC edge banding on top and bottom edges. A 2" x 3/4" rail is tenoned full-length to the inside of the front. Bolting cleats 1-1/4" x 1-1/4" are glued and stapled perpendicular at the ends of the rail and drilled to allow assembly bolts to pass through. A second full-length rail is glued and stapled to the rear of the bolting cleats for support and proper alignment. Bases are manufactured so the base shelf rests on the bolting cleats set behind and flush with the top of the base front.

ATTACHMENT

Four bolts are used to attach each single-faced base or top, except for 16"D single-faced units, on which six bolts are used. Eight bolts are used to attach each double-faced base or top, except for 32"D double-faced units, on which twelve bolts are used. All hardware is concealed from view after assembly. Each single-faced unit is supplied with a metal bracket, lead anchor, and screws for fastening to the wall. Double-faced ranges that do not have partitions receive two steel sway bars per range, 46-7/8" long and 5/16" square. These attach to the starter panel at both sides of the range and the adjoining intermediate panel with screws.

BACKS AND PARTITIONS

Backs and partitions are constructed with 1/4" thick thermally-fused laminate panels.

Note: Backs and partitions do not function with "Book Stop" shelving. Clip and Strip shelving is available for Laminate Shelf units **ONLY** and can be ordered by changing the **RP1** prefix on the starter unit to **RP3**, and changing the **RP2** prefix on the adder unit to **RP4**. i.e.: **RP3-861-S00** or **RP4-861-S00**.

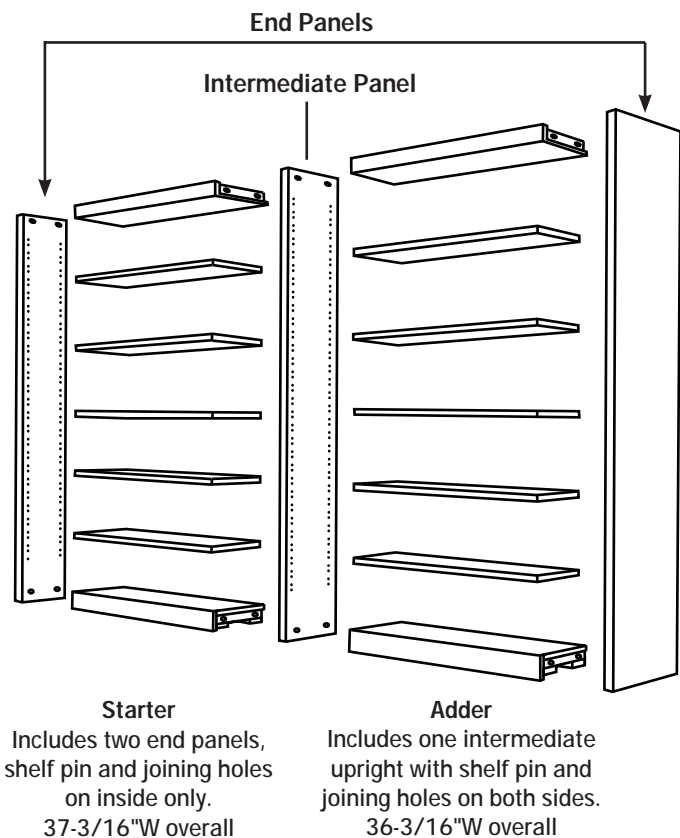

General Specifications - Shelves & Shelving Tops

LAMINATE SHELVES

Shelves are 3/4" thick, thermally-fused laminate, banded on front and back with matching 2mm PVC edgebanding. To ensure adequate support for heavy volumes, a 3/4" thick, 1-1/4" wide support member is attached to the back edge of the bottom of each shelf. Adjustable shelves are grooved 11/32" diameter half round on the underside to set firmly on 1" long, 5/16" diameter threaded shelf pins, cadmium-plated. Shelf depths are nominal.

OMEGA (STEEL) SHELVES

Omega (steel) shelves are designed to fit Brodart's Reprise shelving units. These shelves are 18-gauge steel stamped with notches in the bottom edge to fit over shelf pins. The front and back edges are triple bent for strength and to eliminate sharp edges. Shelves are electrostatic powder coat painted with epoxy paint and oven cured. Shelf accepts spring-type overhead wire book support. Units are supplied with a laminate base shelf. Omega shelves are available in many standard and optional colors - please call for selection.

OMEGA "BOOK STOP" STEEL SHELVES

Omega "Book Stop" steel shelves are designed to fit Brodart's Reprise shelving units. These shelves are 18-gauge steel stamped with notches in the bottom edge to fit over shelf pins. The front and back edges are triple bent for strength and to eliminate sharp edges. The back edge of the shelf is bent upward to form a 90° angle, 1-5/8"H above the shelf surface to function as a book stop. Shelves are electrostatic powder-coat painted with epoxy paint and oven cured. Units are supplied with a metal base shelf. Omega shelves are available in many standard and optional colors - please call for selection.

Note: Backs and partitions do not function with "Book Stop" shelving.

SHELVING TOPS

Cornice tops have a 1-3/8" fascia, constructed with 3/4" thick, thermally-fused laminate panel with matching 2mm PVC edge banding. On the inside surface of the top at each end, butted to the fascia, is a solid hardLaminate bolting cleat 1-1/4" x 1-1/4" that is both glued and stapled. Bolting cleats are drilled to allow assembly bolts to pass through.

Note: Tops on 72"H, 82"H, and 90"H units are inverted. Continuous tops must be ordered separately.

PICTURE BOOK SHELVING

Picture Book Shelving is 12"D with six (6) hardboard dividers per shelf. A 2"H, solid wood back keeps dividers in place.

METAL TILT AND STORE SHELVING

Sloping display shelves have a 13"H clear display area and lift up to expose flat storage shelves via a pivot hinge. Storage space is concealed when display shelves are in normal position.

METAL PICTURE BOOK SHELVING

Metal Picture Book Shelves are 11"D x 7"H overall with two metal dividers per shelf. Dividers can be placed at 26 equal spaces along the width of each shelf. A steel cotter pin is provided with each divider to prevent removal.

PERIODICAL SHELVING

Periodical shelving can display any type of media such as CD's, videocassettes, books and magazines. The shelf can be divided with the six dividers provided with each shelf. Each sloping display shelf will have a 13-3/4"H clear display area.



Flat Laminate Shelf

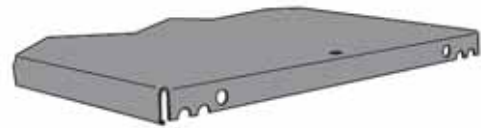

Omega Flat Shelf

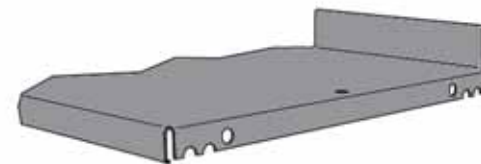

Omega Book Stop Shelf



Shelving Starter/Adder
with Continuous Top

General Specifications - Mobile Units

MOBILE SHELVING UNITS

Mobile Shelving is available on 42", 48", and 60-1/2" units. Shelving construction is the same as the standard shelving with the exception of the base. The base facing is 4-3/8"H, receives four reinforced 14 gauge corner brackets with four 2-1/2" heavy-duty swivel casters attached to a 14-gauge caster bracket. Corner brackets are attached to the end panel and the base facing. The caster assembly is hidden within the base, giving the appearance of standard unit. All mobile units receive partitions, with the exception of Omega Book Stop units, which receive sway braces. Units are offered as starter or starter/adder only.

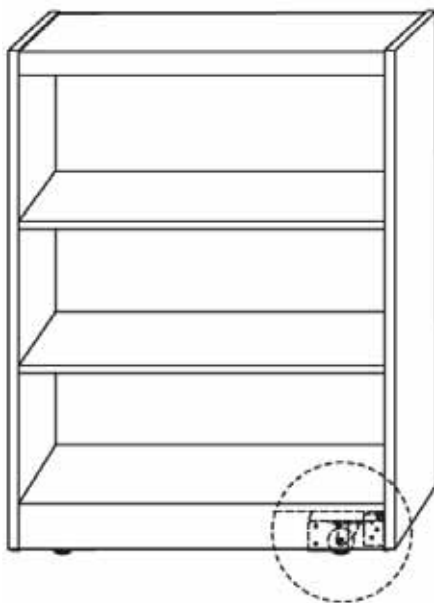

Mobile Shelving Unit

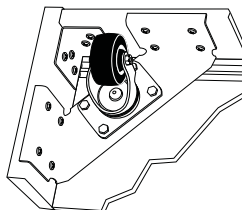



Catalog No.	Description	H x W x D	Wt. (lbs.)	Price
<i>5 Adjustable Shelves, 1 Fixed Shelf and 1 Base Shelf</i>				
RP1-960-S00	S/F Starter	90" x 37-3/16" x 10"	103	\$1,106
RP2-960-S00	S/F Adder	90" x 36-3/16" x 10"	90	\$842
RP1-967-S00	S/F Starter	90" x 37-3/16" x 12"	122	\$1,193
RP2-967-S00	S/F Adder	90" x 36-3/16" x 12"	102	\$907
RP1-673-S00	S/F Starter	90" x 37-3/16" x 16"	127	\$1,327
RP2-673-S00	S/F Adder	90" x 36-3/16" x 16"	107	\$1,040

90"H Laminate Shelves



<i>4 Adjustable Shelves, 1 Fixed Shelf and 1 Base Shelf</i>				
RP1-976-S00	S/F Starter	82" x 37-3/16" x 10"	93	\$1,008
RP2-976-S00	S/F Adder	82" x 36-3/16" x 10"	80	\$764
RP1-977-S00	S/F Starter	82" x 37-3/16" x 12"	112	\$1,089
RP2-977-S00	S/F Adder	82" x 36-3/16" x 12"	92	\$826
RP1-679-S00	S/F Starter	82" x 37-3/16" x 16"	117	\$1,211
RP2-679-S00	S/F Adder	82" x 36-3/16" x 16"	97	\$948

82"H Laminate Shelves



<i>4 Adjustable Shelves and 1 Base Shelf</i>				
RP1-861-S00	S/F Starter	72" x 37-3/16" x 10"	88	\$919
RP2-861-S00	S/F Adder	72" x 36-3/16" x 10"	75	\$695
RP1-863-S00	S/F Starter	72" x 37-3/16" x 12"	102	\$995
RP2-863-S00	S/F Adder	72" x 36-3/16" x 12"	87	\$752
RP1-675-S00	S/F Starter	72" x 37-3/16" x 16"	107	\$1,088
RP2-675-S00	S/F Adder	72" x 36-3/16" x 16"	92	\$861

72"H Laminate Shelves



<i>4 Adjustable Shelves and 1 Base Shelf</i>				
RP1-979-S00	S/F Starter	60-1/2" x 37-3/16" x 10"	75	\$830
RP2-979-S00	S/F Adder	60-1/2" x 36-3/16" x 10"	65	\$627
RP1-988-S00	S/F Starter	60-1/2" x 37-3/16" x 12"	96	\$899
RP2-988-S00	S/F Adder	60-1/2" x 36-3/16" x 12"	81	\$680
RP1-678-S00	S/F Starter	60-1/2" x 37-3/16" x 16"	101	\$988
RP2-678-S00	S/F Adder	60-1/2" x 36-3/16" x 16"	86	\$773

60-1/2"H Laminate Shelves



Please specify Laminate Finishes (Table 4). Details can be found on page GEN 5.

For details regarding Clip & Strip Shelving, please reference the Modifications & Up Charges Section located on page MOD 8.

Note: Shelving Backs and Partitions are sold separately and are located in the Shelving Accessories Section on page REP 33.



48"H Laminate Shelves



Catalog No.	Description	H x W x D	Wt. (lbs.)	Price
<i>2 Adjustable Shelves and 1 Base Shelf</i>				
RP1-761-S00	S/F Starter	48" x 37-3/16" x 10"	71	\$686
RP2-761-S00	S/F Adder	48" x 36-3/16" x 10"	63	\$496
RP1-762-S00	S/F Starter	48" x 37-3/16" x 12"	84	\$731
RP2-762-S00	S/F Adder	48" x 36-3/16" x 12"	74	\$524
RP1-676-S00	S/F Starter	48" x 37-3/16" x 16"	89	\$792
RP2-676-S00	S/F Adder	48" x 36-3/16" x 16"	79	\$583

42"H Laminate Shelves

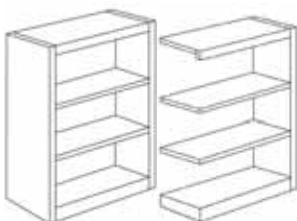

Catalog No.	Description	H x W x D	Wt. (lbs.)	Price
<i>2 Adjustable Shelves and 1 Base Shelf</i>				
RP1-981-S00	S/F Starter	42" x 37-3/16" x 10"	61	\$648
RP2-981-S00	S/F Adder	42" x 36-3/16" x 10"	53	\$463
RP1-989-S00	S/F Starter	42" x 37-3/16" x 12"	74	\$690
RP2-989-S00	S/F Adder	42" x 36-3/16" x 12"	64	\$486
RP1-677-S00	S/F Starter	42" x 37-3/16" x 16"	79	\$716
RP2-677-S00	S/F Adder	42" x 36-3/16" x 16"	68	\$508

Please specify Laminate Finishes (Table 4). Details can be found on page GEN 5.

For details regarding Clip & Strip Shelving, please reference the Modifications & Up Charges Section located on page MOD 8.

Note: Shelving Backs and Partitions are sold separately and are located in the Shelving Accessories Section on page REP 33.



Catalog No.	Description	H x W x D	Wt. (lbs.)	Price
5 Adjustable Shelves, 1 Fixed Shelf and 1 Base Shelf per Side				
RP1-969-S00	D/F Starter	90" x 37-3/16" x 20"	185	\$1,936
RP2-969-S00	D/F Adder	90" x 36-3/16" x 20"	153	\$1,529
RP1-973-S00	D/F Starter	90" x 37-3/16" x 24"	224	\$2,095
RP2-973-S00	D/F Adder	90" x 36-3/16" x 24"	188	\$1,628
RP1-683-S00	D/F Starter	90" x 37-3/16" x 32"	239	\$2,328
RP2-683-S00	D/F Adder	90" x 36-3/16" x 32"	203	\$1,868

90"H Laminate Shelves



4 Adjustable Shelves, 1 Fixed Shelf and 1 Base Shelf per Side

RP1-983-S00	D/F Starter	82" x 37-3/16" x 20"	175	\$1,809
RP2-983-S00	D/F Adder	82" x 36-3/16" x 20"	143	\$1,409
RP1-990-S00	D/F Starter	82" x 37-3/16" x 24"	214	\$1,973
RP2-990-S00	D/F Adder	82" x 36-3/16" x 24"	178	\$1,517
RP1-689-S00	D/F Starter	82" x 37-3/16" x 32"	229	\$2,192
RP2-689-S00	D/F Adder	82" x 36-3/16" x 32"	193	\$1,742

82"H Laminate Shelves

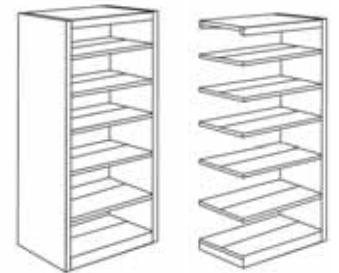

4 Adjustable Shelves and 1 Base Shelf per Side

RP1-865-S00	D/F Starter	72" x 37-3/16" x 20"	160	\$1,719
RP2-865-S00	D/F Adder	72" x 36-3/16" x 20"	128	\$1,321
RP1-866-S00	D/F Starter	72" x 37-3/16" x 24"	199	\$1,855
RP2-866-S00	D/F Adder	72" x 36-3/16" x 24"	163	\$1,430
RP1-685-S00	D/F Starter	72" x 37-3/16" x 32"	214	\$1,967
RP2-685-S00	D/F Adder	72" x 36-3/16" x 32"	178	\$1,638

72"H Laminate Shelves



4 Adjustable Shelves and 1 Base Shelf per Side

RP1-985-S00	D/F Starter	60-1/2" x 37-3/16" x 20"	139	\$1,628
RP2-985-S00	D/F Adder	60-1/2" x 36-3/16" x 20"	115	\$1,235
RP1-986-S00	D/F Starter	60-1/2" x 37-3/16" x 24"	170	\$1,733
RP2-986-S00	D/F Adder	60-1/2" x 36-3/16" x 24"	142	\$1,345
RP1-688-S00	D/F Starter	60-1/2" x 37-3/16" x 32"	185	\$1,908
RP2-688-S00	D/F Adder	60-1/2" x 36-3/16" x 32"	157	\$1,529

60-1/2"H Laminate Shelves



Please specify Laminate Finishes (Table 4). Details can be found on page GEN 5.

For details regarding Clip & Strip Shelving, please reference the Modifications & Up Charges Section located on page MOD 8.

Note: Shelving Backs and Partitions are sold separately and are located in the Shelving Accessories Section on page REP 33.



	Catalog No.	Description	H x W x D	Wt. (lbs.)	Price
48"H Laminate Shelves	<i>2 Adjustable Shelves and 1 Base Shelf per Side</i>				
	RP1-765-S00	D/F Starter	48" x 37-3/16" x 20"	111	\$1,241
	RP2-765-S00	D/F Adder	48" x 36-3/16" x 20"	96	\$932
	RP1-766-S00	D/F Starter	48" x 37-3/16" x 24"	134	\$1,298
	RP2-766-S00	D/F Adder	48" x 36-3/16" x 24"	111	\$996
	RP1-686-S00	D/F Starter	48" x 37-3/16" x 32"	145	\$1,406
	RP2-686-S00	D/F Adder	48" x 36-3/16" x 32"	122	\$1,107

	Catalog No.	Description	H x W x D	Wt. (lbs.)	Price
42"H Laminate Shelves	<i>2 Adjustable Shelves and 1 Base Shelf per Side</i>				
	RP1-987-S00	D/F Starter	42" x 37-3/16" x 20"	101	\$1,143
	RP2-987-S00	D/F Adder	42" x 36-3/16" x 20"	86	\$854
	RP1-991-S00	D/F Starter	42" x 37-3/16" x 24"	124	\$1,190
	RP2-991-S00	D/F Adder	42" x 36-3/16" x 24"	105	\$907
	RP1-687-S00	D/F Starter	42" x 37-3/16" x 32"	135	\$1,245
	RP2-687-S00	D/F Adder	42" x 36-3/16" x 32"	116	\$949

Please specify Laminate Finishes (Table 4). Details can be found on page GEN 5.

For details regarding Clip & Strip Shelving, please reference the Modifications & Up Charges Section located on page MOD 8.

Note: Shelving Backs and Partitions are sold separately and are located in the Shelving Accessories Section on page REP 33.

Picture Book Shelving

Picture Book Shelving is 12"D with six (6) hardboard dividers per shelf. A 2"H, solid wood back keeps dividers in place.



Catalog No.	Description	H x W x D	Wt. (lbs.)	Price	
<i>2 Adjustable Picture Book with Divider Shelves and 1 Base Shelf</i>					60-1/2"H Laminate Picture Book Shelves
RP1-931-S00	S/F Starter	60-1/2" x 37-3/16" x 12"	105	\$965	
RP2-931-S00	S/F Adder	60-1/2" x 36-3/16" x 12"	90	\$695	

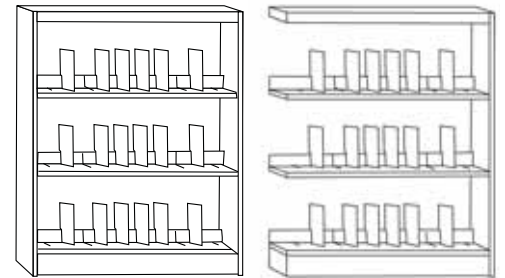

<i>1 Adjustable Picture Book with Divider Shelves and 1 Base Shelf</i>					48"H Laminate Picture Book Shelves
RP1-929-S00	S/F Starter	48" x 37-3/16" x 12"	86	\$893	
RP2-929-S00	S/F Adder	48" x 36-3/16" x 12"	76	\$667	



<i>1 Adjustable Picture Book with Divider Shelves and 1 Base Shelf</i>					42"H Laminate Picture Book Shelves
RP1-932-S00	S/F Starter	42" x 37-3/16" x 12"	78	\$743	
RP2-932-S00	S/F Adder	42" x 36-3/16" x 12"	68	\$532	



Please specify Laminate Finishes (Table 4). Details can be found on page GEN 5.

For details regarding Clip & Strip Shelving, please reference the Modifications & Up Charges Section located on page MOD 8.

Note: Shelving Backs and Partitions are sold separately and are located in the Shelving Accessories Section on page REP 33.



Picture Book Shelving

Picture Book Shelving is 12"D with six (6) hardboard dividers per shelf. A 2"H, solid wood back keeps dividers in place.

	Catalog No.	Description	H x W x D	Wt. (lbs.)	Price
60-1/2"H Laminate Picture Book Shelves	<i>2 Adjustable Picture Book with Divider Shelves and 1 Base Shelf per Side</i>				
	RP1-933-S00	D/F Starter	60-1/2" x 37-3/16" x 24"	180	\$1,837
	RP2-933-S00	D/F Adder	60-1/2" x 36-3/16" x 24"	152	\$1,346

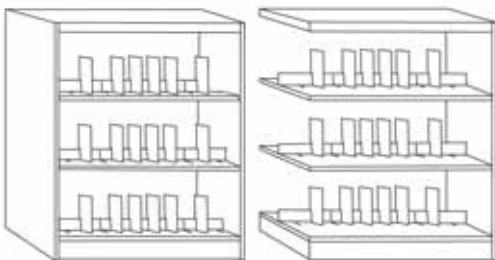

48"H Laminate Picture Book Shelves	<i>1 Adjustable Picture Book with Divider Shelves and 1 Base Shelf per Side</i>				
	RP1-930-S00	D/F Starter	48" x 37-3/16" x 24"	149	\$1,427
	RP2-930-S00	D/F Adder	48" x 36-3/16" x 24"	130	\$1,096

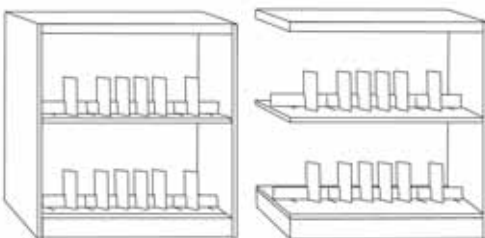

42"H Laminate Picture Book Shelves	<i>1 Adjustable Picture Book with Divider Shelves and 1 Base Shelf per Side</i>				
	RP1-934-S00	D/F Starter	42" x 37-3/16" x 24"	130	\$1,273
	RP2-934-S00	D/F Adder	42" x 36-3/16" x 24"	110	\$1,038

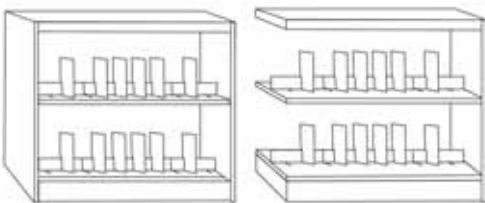

Please specify Laminate Finishes (Table 4). Details can be found on page GEN 5.

For details regarding Clip & Strip Shelving, please reference the Modifications & Up Charges Section located on page MOD 8.

Note: Shelving Backs and Partitions are sold separately and are located in the Shelving Accessories Section on page REP 33.



Catalog No.	Description	H x W x D	Wt. (lbs.)	Price
5 Adjustable Metal Shelves, 1 Fixed Shelf and 1 Thermally-Fused Laminate Base Shelf				
RP5-960-S00	S/F Starter	90" x 37-3/16" x 10"	103	\$1,030
RP6-960-S00	S/F Adder	90" x 36-3/16" x 10"	90	\$780
RP5-967-S00	S/F Starter	90" x 37-3/16" x 12"	122	\$1,158
RP6-967-S00	S/F Adder	90" x 36-3/16" x 12"	102	\$833

90"H Omega Shelves



4 Adjustable Metal Shelves, 1 Fixed Shelf and 1 Thermally-Fused Laminate Base Shelf				
RP5-976-S00	S/F Starter	82" x 37-3/16" x 10"	93	\$940
RP6-976-S00	S/F Adder	82" x 36-3/16" x 10"	80	\$714
RP5-977-S00	S/F Starter	82" x 37-3/16" x 12"	112	\$1,054
RP6-977-S00	S/F Adder	82" x 36-3/16" x 12"	92	\$772

82"H Omega Shelves



4 Adjustable Metal Shelves and 1 Thermally-Fused Laminate Base Shelf				
RP5-861-S00	S/F Starter	72" x 37-3/16" x 10"	88	\$857
RP6-861-S00	S/F Adder	72" x 36-3/16" x 10"	75	\$654
RP5-863-S00	S/F Starter	72" x 37-3/16" x 12"	102	\$961
RP6-863-S00	S/F Adder	72" x 36-3/16" x 12"	87	\$717

72"H Omega Shelves



4 Adjustable Metal Shelves and 1 Thermally-Fused Laminate Base Shelf				
RP5-979-S00	S/F Starter	60-1/2" x 37-3/16" x 10"	75	\$776
RP6-979-S00	S/F Adder	60-1/2" x 36-3/16" x 10"	65	\$594
RP5-988-S00	S/F Starter	60-1/2" x 37-3/16" x 12"	96	\$870
RP6-988-S00	S/F Adder	60-1/2" x 36-3/16" x 12"	81	\$660

60-1/2"H Omega Shelves



Please specify Laminate Finishes (Table 4) and Metal Color (Table 5). Details can be found on page GEN 5.

Note: Shelving Backs and Partitions are sold separately and are located in the Shelving Accessories Section on page REP 33.
Clip & Strip Shelving CANNOT be used with Omega Shelves.



48"H Omega Shelves

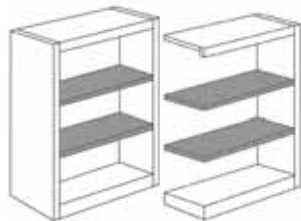

Catalog No.	Description	H x W x D	Wt. (lbs.)	Price
<i>2 Adjustable Metal Shelves and 1 Thermally-Fused Laminate Base Shelf</i>				
RP5-761-S00	S/F Starter	48" x 37-3/16" x 10"	65	\$665
RP6-761-S00	S/F Adder	48" x 36-3/16" x 10"	57	\$486
RP5-762-S00	S/F Starter	48" x 37-3/16" x 12"	78	\$708
RP6-762-S00	S/F Adder	48" x 36-3/16" x 12"	68	\$510

42"H Omega Shelves

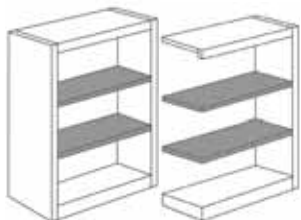

Catalog No.	Description	H x W x D	Wt. (lbs.)	Price
<i>2 Adjustable Metal Shelves and 1 Thermally-Fused Laminate Base Shelf</i>				
RP5-981-S00	S/F Starter	42" x 37-3/16" x 10"	61	\$636
RP6-981-S00	S/F Adder	42" x 36-3/16" x 10"	53	\$458
RP5-989-S00	S/F Starter	42" x 37-3/16" x 12"	74	\$667
RP6-989-S00	S/F Adder	42" x 36-3/16" x 12"	64	\$473

Please specify Laminate Finishes (Table 4) and Metal Color (Table 5). Details can be found on page GEN 5.

Note: Shelving Backs and Partitions are sold separately and are located in the Shelving Accessories Section on page REP 33.
Clip & Strip Shelving CANNOT be used with Omega Shelves.



5 Adjustable Metal Shelves, 1 Fixed Shelf and 1 Thermally-Fused Laminate Base Shelf per Side

90"H Omega Shelves

Catalog No.	Description	H x W x D	Wt. (lbs.)	Price
RP5-969-S00	D/F Starter	90" x 37-3/16" x 20"	185	\$1,730
RP6-969-S00	D/F Adder	90" x 36-3/16" x 20"	153	\$1,302
RP5-973-S00	D/F Starter	90" x 37-3/16" x 24"	224	\$2,073
RP6-973-S00	D/F Adder	90" x 36-3/16" x 24"	188	\$1,440



4 Adjustable Metal Shelves, 1 Fixed Shelf and 1 Thermally-Fused Laminate Base Shelf per Side

82"H Omega Shelves

RP5-983-S00	D/F Starter	82" x 37-3/16" x 20"	175	\$1,643
RP6-983-S00	D/F Adder	82" x 36-3/16" x 20"	143	\$1,262
RP5-990-S00	D/F Starter	82" x 37-3/16" x 24"	214	\$1,934
RP6-990-S00	D/F Adder	82" x 36-3/16" x 24"	178	\$1,393



4 Adjustable Metal Shelves and 1 Thermally-Fused Laminate Base Shelf per Side

72"H Omega Shelves

RP5-865-S00	D/F Starter	72" x 37-3/16" x 20"	160	\$1,560
RP6-865-S00	D/F Adder	72" x 36-3/16" x 20"	128	\$1,223
RP5-866-S00	D/F Starter	72" x 37-3/16" x 24"	199	\$1,805
RP6-866-S00	D/F Adder	72" x 36-3/16" x 24"	163	\$1,347



4 Adjustable Metal Shelves and 1 Thermally-Fused Laminate Base Shelf per Side

60-1/2"H Omega Shelves

RP5-985-S00	D/F Starter	60-1/2" x 37-3/16" x 20"	139	\$1,479
RP6-985-S00	D/F Adder	60-1/2" x 36-3/16" x 20"	115	\$1,185
RP5-986-S00	D/F Starter	60-1/2" x 37-3/16" x 24"	170	\$1,676
RP6-986-S00	D/F Adder	60-1/2" x 36-3/16" x 24"	142	\$1,300

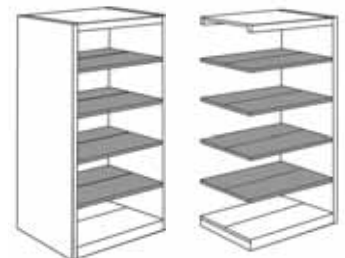

Please specify Laminate Finishes (Table 4) and Metal Color (Table 5). Details can be found on page GEN 5.

Note: Shelving Backs and Partitions are sold separately and are located in the Shelving Accessories Section on page REP 33.
Clip & Strip Shelving CANNOT be used with Omega Shelves.



48"H Omega Shelves

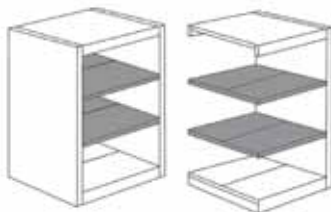

Catalog No.	Description	H x W x D	Wt. (lbs.)	Price
<i>2 Adjustable Metal Shelves and 1 Thermally-Fused Laminate Base Shelf per Side</i>				
RP5-765-S00	D/F Starter	48" x 37-3/16" x 20"	111	\$1,168
RP6-765-S00	D/F Adder	48" x 36-3/16" x 20"	96	\$857
RP5-766-S00	D/F Starter	48" x 37-3/16" x 24"	134	\$1,262
RP6-766-S00	D/F Adder	48" x 36-3/16" x 24"	111	\$946

42"H Omega Shelves

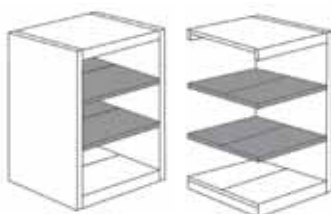

Catalog No.	Description	H x W x D	Wt. (lbs.)	Price
<i>2 Adjustable Metal Shelves and 1 Thermally-Fused Laminate Base Shelf per Side</i>				
RP5-987-S00	D/F Starter	42" x 37-3/16" x 20"	101	\$1,090
RP6-987-S00	D/F Adder	42" x 36-3/16" x 20"	86	\$776
RP5-991-S00	D/F Starter	42" x 37-3/16" x 24"	124	\$1,158
RP6-991-S00	D/F Adder	42" x 36-3/16" x 24"	105	\$858

Please specify Laminate Finishes (Table 4) and Metal Color (Table 5). Details can be found on page GEN 5.

Note: Shelving Backs and Partitions are sold separately and are located in the Shelving Accessories Section on page REP 33.
Clip & Strip Shelving CANNOT be used with Omega Shelves.



Catalog No.	Description	H x W x D	Wt. (lbs.)	Price
5 Adjustable Metal Shelves, 1 Fixed Metal Shelf and 1 Metal Base Shelf				
RP7-960-S00	S/F Starter	90" x 37-3/16" x 10"	103	\$1,030
RP8-960-S00	S/F Adder	90" x 36-3/16" x 10"	90	\$780
RP7-967-S00	S/F Starter	90" x 37-3/16" x 12"	122	\$1,158
RP8-967-S00	S/F Adder	90" x 36-3/16" x 12"	102	\$833

90"H Omega Book Stop Shelves



4 Adjustable Metal Shelves, 1 Fixed Metal Shelf and 1 Metal Base Shelf				
RP7-976-S00	S/F Starter	82" x 37-3/16" x 10"	93	\$1,052
RP8-976-S00	S/F Adder	82" x 36-3/16" x 10"	80	\$819
RP7-977-S00	S/F Starter	82" x 37-3/16" x 12"	112	\$1,185
RP8-977-S00	S/F Adder	82" x 36-3/16" x 12"	92	\$880

82"H Omega Book Stop Shelves



4 Adjustable Metal Shelves and 1 Metal Base Shelf				
RP7-861-S00	S/F Starter	72" x 37-3/16" x 10"	88	\$942
RP8-861-S00	S/F Adder	72" x 36-3/16" x 10"	75	\$735
RP7-863-S00	S/F Starter	72" x 37-3/16" x 12"	102	\$1,077
RP8-863-S00	S/F Adder	72" x 36-3/16" x 12"	87	\$799

72"H Omega Book Stop Shelves



4 Adjustable Metal Shelves and 1 Metal Base Shelf				
RP7-979-S00	S/F Starter	60-1/2" x 37-3/16" x 10"	75	\$833
RP8-979-S00	S/F Adder	60-1/2" x 36-3/16" x 10"	65	\$652
RP7-988-S00	S/F Starter	60-1/2" x 37-3/16" x 12"	96	\$969
RP8-988-S00	S/F Adder	60-1/2" x 36-3/16" x 12"	81	\$716

60-1/2"H Omega Book Stop Shelves



Please specify Laminate Finishes (Table 4) and Metal Color (Table 5). Details can be found on page GEN 5.

Note: Shelving Backs and Partitions CANNOT be used with Book Stop Shelving.
Clip & Strip Shelving CANNOT be used with Omega Shelves.



48"H Omega Book Stop Shelves



Catalog No.	Description	H x W x D	Wt. (lbs.)	Price
<u>2 Adjustable Metal Shelves and 1 Metal Base Shelf</u>				
RP7-761-S00	S/F Starter	48" x 37-3/16" x 10"	71	\$701
RP8-761-S00	S/F Adder	48" x 36-3/16" x 10"	63	\$521
RP7-762-S00	S/F Starter	48" x 37-3/16" x 12"	84	\$760
RP8-762-S00	S/F Adder	48" x 36-3/16" x 12"	74	\$549

42"H Omega Book Stop Shelves



Catalog No.	Description	H x W x D	Wt. (lbs.)	Price
<u>2 Adjustable Metal Shelves and 1 Metal Base Shelf</u>				
RP7-981-S00	S/F Starter	42" x 37-3/16" x 10"	61	\$668
RP8-981-S00	S/F Adder	42" x 36-3/16" x 10"	53	\$488
RP7-989-S00	S/F Starter	42" x 37-3/16" x 12"	74	\$708
RP8-989-S00	S/F Adder	42" x 36-3/16" x 12"	64	\$510

Please specify Laminate Finishes (Table 4) and Metal Color (Table 5). Details can be found on page GEN 5.

Note: Shelving Backs and Partitions CANNOT be used with Book Stop Shelving.
Clip & Strip Shelving CANNOT be used with Omega Shelves.



Catalog No.	Description	H x W x D	Wt. (lbs.)	Price
5 Adjustable Metal Shelves, 1 Fixed Metal Shelf and 1 Metal Base Shelf per Side				
RP7-969-S00	D/F Starter	90" x 37-3/16" x 20"	185	\$2,012
RP8-969-S00	D/F Adder	90" x 36-3/16" x 20"	153	\$1,566
RP7-973-S00	D/F Starter	90" x 37-3/16" x 24"	224	\$2,368
RP8-973-S00	D/F Adder	90" x 36-3/16" x 24"	188	\$1,710

90"H Omega Book Stop Shelves

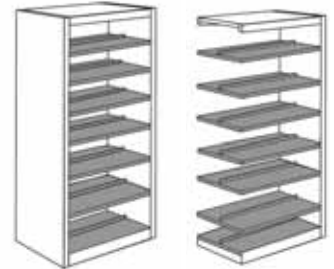

4 Adjustable Metal Shelves, 1 Fixed Metal Shelf and 1 Metal Base Shelf per Side

RP7-983-S00	D/F Starter	82" x 37-3/16" x 20"	175	\$1,865
RP8-983-S00	D/F Adder	82" x 36-3/16" x 20"	143	\$1,473
RP7-990-S00	D/F Starter	82" x 37-3/16" x 24"	214	\$2,162
RP8-990-S00	D/F Adder	82" x 36-3/16" x 24"	178	\$1,602

82"H Omega Book Stop Shelves



4 Adjustable Metal Shelves and 1 Metal Base Shelf per Side

RP7-865-S00	D/F Starter	72" x 37-3/16" x 20"	160	\$1,729
RP8-865-S00	D/F Adder	72" x 36-3/16" x 20"	128	\$1,384
RP7-866-S00	D/F Starter	72" x 37-3/16" x 24"	199	\$1,977
RP8-866-S00	D/F Adder	72" x 36-3/16" x 24"	163	\$1,501

72"H Omega Book Stop Shelves



4 Adjustable Metal Shelves and 1 Metal Base Shelf per Side

RP7-985-S00	D/F Starter	60-1/2" x 37-3/16" x 20"	139	\$1,591
RP8-985-S00	D/F Adder	60-1/2" x 36-3/16" x 20"	115	\$1,298
RP7-986-S00	D/F Starter	60-1/2" x 37-3/16" x 24"	170	\$1,787
RP8-986-S00	D/F Adder	60-1/2" x 36-3/16" x 24"	142	\$1,401

60-1/2"H Omega Book Stop Shelves



Please specify Laminate Finishes (Table 4) and Metal Color (Table 5). Details can be found on page GEN 5.

Note: Shelving Backs and Partitions CANNOT be used with Book Stop Shelving.
Clip & Strip Shelving CANNOT be used with Omega Shelves.



48"H Omega Book Stop Shelves

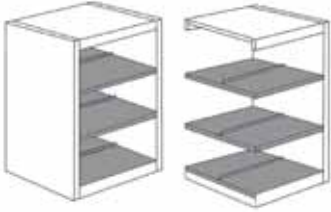

Catalog No.	Description	H x W x D	Wt. (lbs.)	Price
<i>2 Adjustable Metal Shelves and 1 Metal Base Shelf per Side</i>				
RP7-765-S00	D/F Starter	48" x 37-3/16" x 20"	111	\$1,242
RP8-765-S00	D/F Adder	48" x 36-3/16" x 20"	96	\$931
RP7-766-S00	D/F Starter	48" x 37-3/16" x 24"	134	\$1,335
RP8-766-S00	D/F Adder	48" x 36-3/16" x 24"	111	\$1,018

42"H Omega Book Stop Shelves



Catalog No.	Description	H x W x D	Wt. (lbs.)	Price
<i>2 Adjustable Metal Shelves and 1 Metal Base Shelf per Side</i>				
RP7-987-S00	D/F Starter	42" x 37-3/16" x 20"	101	\$1,155
RP8-987-S00	D/F Adder	42" x 36-3/16" x 20"	86	\$839
RP7-991-S00	D/F Starter	42" x 37-3/16" x 24"	124	\$1,223
RP8-991-S00	D/F Adder	42" x 36-3/16" x 24"	105	\$922

Please specify Laminate Finishes (Table 4) and Metal Color (Table 5). Details can be found on page GEN 5.

Note: Shelving Backs and Partitions CANNOT be used with Book Stop Shelving.
Clip & Strip Shelving CANNOT be used with Omega Shelves.

Omega Periodical Display Shelves, Single-Faced

Reprise Shelving

Periodical Display Shelving

Periodical Display Shelves are 13"H with a 3/4"H retaining lip. The display shelves are adjustable on a pin and hole system but they do not tilt. Each sloping display shelf has a 13-3/4"H clear display area.

Note: Each metal display shelf receives 6 metal dividers per shelf.

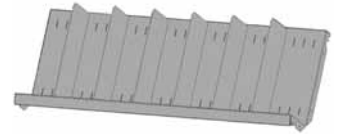

Catalog No.	Description	H x W x D	Wt. (lbs.)	Price
<i>5 Display Metal Shelves, 3 Adjustable Metal Shelves, 1 Fixed Metal Shelf and 1 Thermally-Fused Laminate Base Shelf</i>				

RP7-918-S00	S/F Starter	82" x 37-3/16" x 12"	120	\$1,621
RP8-918-S00	S/F Adder	82" x 36-3/16" x 12"	100	\$1,233

82"H Omega Periodical Display Shelves

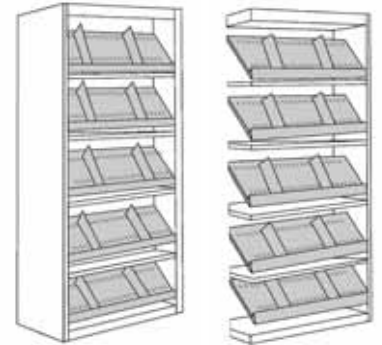

<i>4 Display Metal Shelves, 3 Adjustable Metal Shelves and 1 Thermally-Fused Laminate Base Shelf</i>				
---	--	--	--	--

RP7-875-S00	S/F Starter	72" x 37-3/16" x 12"	114	\$1,407
RP8-875-S00	S/F Adder	72" x 36-3/16" x 12"	95	\$1,053

72"H Omega Periodical Display Shelves

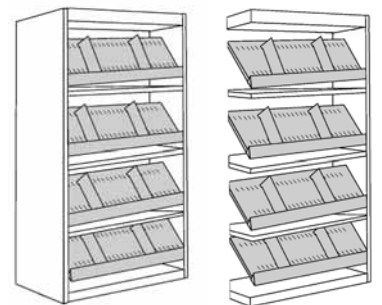

<i>3 Display Metal Shelves, 2 Adjustable Metal Shelves and 1 Thermally-Fused Laminate Base Shelf</i>				
---	--	--	--	--

RP7-920-S00	S/F Starter	60-1/2" x 37-3/16" x 12"	105	\$1,190
RP8-920-S00	S/F Adder	60-1/2" x 36-3/16" x 12"	90	\$871

60-1/2"H Omega Periodical Display Shelf

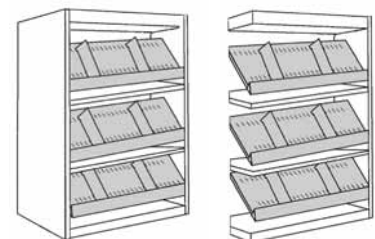

Please specify Laminate Finishes (Table 4) and Metal Color (Table 5). Details can be found on page GEN 5.

Note: Shelving Backs and Partitions are sold separately and are located in the Shelving Accessories Section on page REP 35.
Clip & Strip Shelving CANNOT be used with Omega Shelves.

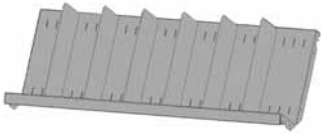

Periodical Display Shelving

Periodical Display Shelves are 13"H with a 3/4"H retaining lip. The display shelves are adjustable on a pin and hole system but they do not tilt. Each sloping display shelf has a 13-3/4"H clear display area.

Note: Each metal display shelf receives 6 metal dividers per shelf.

48"H Omega Periodical Display Shelves

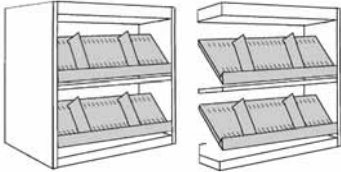

Catalog No.	Description	H x W x D	Wt. (lbs.)	Price
<u>2 Display Metal Shelves, 1 Adjustable Metal Shelf and 1 Thermally-Fused Laminate Base Shelf</u>				

RP7-919-S00	S/F Starter	48" x 37-3/16" x 12"	90	\$1,040
RP8-919-S00	S/F Adder	48" x 36-3/16" x 12"	80	\$804

42"H Omega Periodical Display Shelves

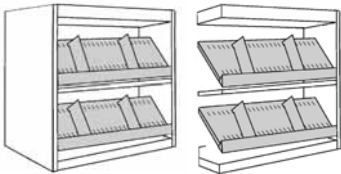

<u>2 Display Metal Shelves, 1 Adjustable Metal Shelf and 1 Thermally-Fused Laminate Base Shelf</u>				
---	--	--	--	--

RP7-921-S00	S/F Starter	42" x 37-3/16" x 12"	80	\$898
RP8-921-S00	S/F Adder	42" x 36-3/16" x 12"	70	\$737

Please specify Laminate Finishes (Table 4) and Metal Color (Table 5). Details can be found on page GEN 5.

Note: Shelving Backs and Partitions are sold separately and are located in the Shelving Accessories Section on page REP 35.
Clip & Strip Shelving CANNOT be used with Omega Shelves.

Periodical Display Shelving

Periodical Display Shelves are 13"H with a 3/4"H retaining lip. The display shelves are adjustable on a pin and hole system but they do not tilt. Each sloping display shelf has a 13-3/4"H clear display area.

Note: Each metal display shelf receives 6 metal dividers per shelf.

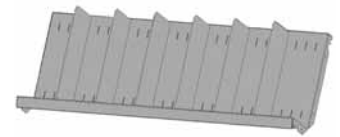

Catalog No.	Description	H x W x D	Wt. (lbs.)	Price
-------------	-------------	-----------	------------	-------

5 Display Metal Shelves, 3 Adjustable Metal Shelves, 1 Fixed Metal Shelf and 1 Thermally-Fused Laminate Base Shelf per Side

82"H Omega Periodical Display Shelves

RP7-922-S00	D/F Starter	82" x 37-3/16" x 24"	230	\$2,940
RP8-922-S00	D/F Adder	82" x 36-3/16" x 24"	194	\$2,476

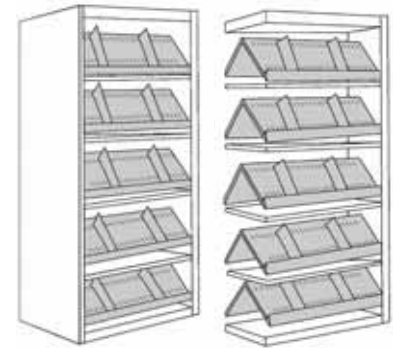

4 Display Metal Shelves, 3 Adjustable Metal Shelves and 1 Thermally-Fused Laminate Base Shelf per Side

72"H Omega Periodical Display Shelves

RP7-876-S00	D/F Starter	72" x 37-3/16" x 24"	210	\$2,675
RP8-876-S00	D/F Adder	72" x 36-3/16" x 24"	180	\$2,253

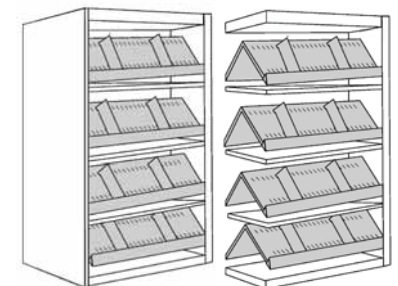

3 Display Metal Shelves, 2 Adjustable Metal Shelves and 1 Thermally-Fused Laminate Base Shelf per Side

60-1/2"H Omega Periodical Display Shelf

RP7-923-S00	D/F Starter	60-1/2" x 37-3/16" x 24"	185	\$2,117
RP8-923-S00	D/F Adder	60-1/2" x 36-3/16" x 24"	157	\$1,662

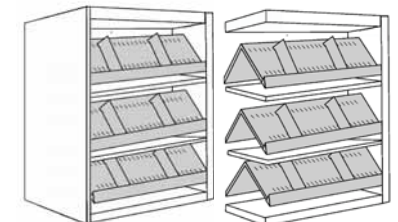

Please specify Laminate Finishes (Table 4) and Metal Color (Table 5). Details can be found on page GEN 5.

Note: Shelving Backs and Partitions are sold separately and are located in the Shelving Accessories Section on page REP 35.
Clip & Strip Shelving CANNOT be used with Omega Shelves.

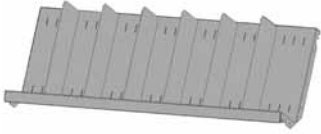

Periodical Display Shelving

Periodical Display Shelves are 13"H with a 3/4"H retaining lip. The display shelves are adjustable on a pin and hole system but they do not tilt. Each sloping display shelf has a 13-3/4"H clear display area.

Note: Each metal display shelf receives 6 metal dividers per shelf.

48"H Omega Periodical Display Shelves

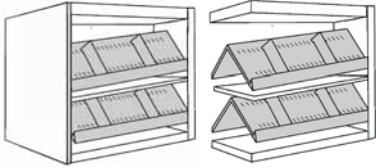

Catalog No.	Description	H x W x D	Wt. (lbs.)	Price
<u>2 Display Metal Shelves, 1 Adjustable Metal Shelf and 1 Thermally-Fused Laminate Base Shelf per side</u>				

RP7-925-S00	D/F Starter	48" x 37-3/16" x 24"	150	\$1,906
RP8-925-S00	D/F Adder	48" x 36-3/16" x 24"	130	\$1,447

42"H Omega Periodical Display Shelves

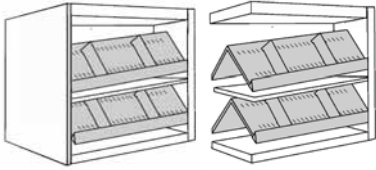

Catalog No.	Description	H x W x D	Wt. (lbs.)	Price
<u>2 Display Metal Shelves, 1 Adjustable Metal Shelf and 1 Thermally-Fused Laminate Base Shelf per side</u>				

RP7-924-S00	D/F Starter	42" x 37-3/16" x 24"	130	\$1,701
RP8-924-S00	D/F Adder	42" x 36-3/16" x 24"	111	\$1,233

Please specify Laminate Finishes (Table 4) and Metal Color (Table 5). Details can be found on page GEN 5.

Note: Shelving Backs and Partitions are sold separately and are located in the Shelving Accessories Section on page REP 35.
Clip & Strip Shelving CANNOT be used with Omega Shelves.

Metal Tilt and Store Shelving

Sloping display shelves have a 13"H clear display area and lift up to expose flat storage shelves via a pivot hinge. Storage space is concealed when display shelves are in normal position.

Note: Tilt and Store Shelving is available in 16" depth ONLY.

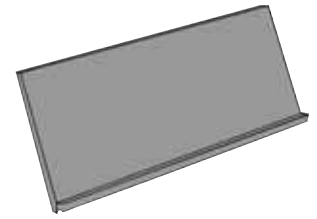

5 Tilting Metal Shelves, 4 Flat Wood Shelves and 1 Thermally-Fused Laminate Base Shelf

Catalog No.	Description	H x W x D	Wt. (lbs.)	Price
RP7-935-S00	S/F Starter	82" x 37-3/16" x 16"	250	\$2,096
RP8-935-S00	S/F Adder	82" x 36-3/16" x 16"	214	\$1,760

82"H Omega Tilt & Store Shelves

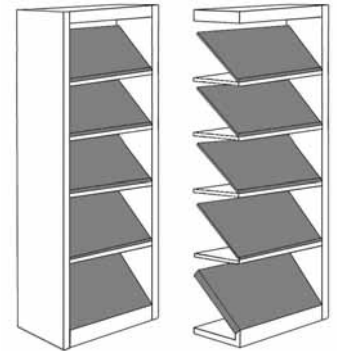

4 Tilting Metal Shelves, 3 Flat Wood Shelves and 1 Thermally-Fused Laminate Base Shelf

RP7-880-S00	S/F Starter	72" x 37-3/16" x 16"	220	\$1,987
RP8-880-S00	S/F Adder	72" x 36-3/16" x 16"	180	\$1,563

72"H Omega Tilt & Store Shelves

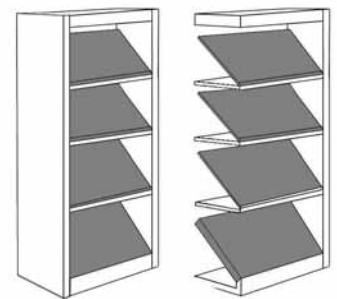

3 Tilting Metal Shelves, 2 Flat Wood Shelves and 1 Thermally-Fused Laminate Base Shelf

RP7-936-S00	S/F Starter	60-1/2" x 37-3/16" x 16"	180	\$1,879
RP8-936-S00	S/F Adder	60-1/2" x 36-3/16" x 16"	130	\$1,363

60-1/2"H Omega Tilt & Store Shelves

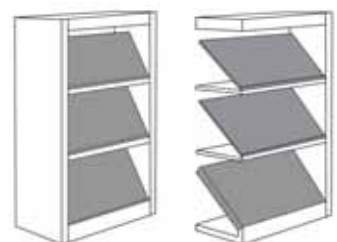

Please specify Laminate Finishes (Table 4) and Metal Color (Table 5). Details can be found on page GEN 5.

Note: Shelving Backs and Partitions are sold separately and are located in the Shelving Accessories Section on page REP 35.
Clip & Strip Shelving CANNOT be used with Omega Shelves.

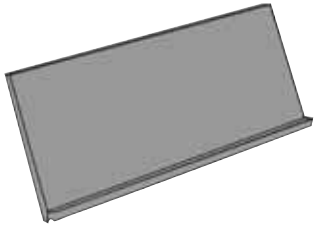

Metal Tilt and Store Shelving

Sloping display shelves have a 13"H clear display area and lift up to expose flat storage shelves via a pivot hinge. Storage space is concealed when display shelves are in normal position.

Note: Tilt and Store Shelving is available in 16" depth ONLY.

48"H Omega Tilt & Store Shelves

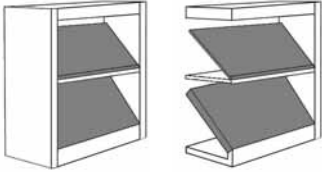

Catalog No.	Description	H x W x D	Wt. (lbs.)	Price
<u>2 Tilting Metal Shelves, 1 Flat Wood Shelves and 1 Thermally-Fused Laminate Base Shelf</u>				
RP7-938-S00	S/F Starter	48" x 37-3/16" x 16"	120	\$1,676
RP8-938-S00	S/F Adder	48" x 36-3/16" x 16"	110	\$1,283

42"H Omega Tilt & Store Shelves

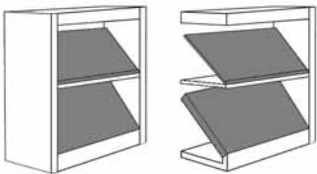

Catalog No.	Description	H x W x D	Wt. (lbs.)	Price
<u>2 Tilting Metal Shelves, 1 Flat Wood Shelves and 1 Thermally-Fused Laminate Base Shelf</u>				
RP7-937-S00	S/F Starter	42" x 37-3/16" x 16"	100	\$1,474
RP8-937-S00	S/F Adder	42" x 36-3/16" x 16"	90	\$1,202

Please specify Laminate Finishes (Table 4) and Metal Color (Table 5). Details can be found on page GEN 5.

Note: Shelving Backs and Partitions are sold separately and are located in the Shelving Accessories Section on page REP 35.
Clip & Strip Shelving CANNOT be used with Omega Shelves.

Metal Tilt and Store Shelving

Sloping display shelves have a 13"H clear display area and lift up to expose flat storage shelves via a pivot hinge. Storage space is concealed when display shelves are in normal position.

Note: Tilt and Store Shelving is available in 16" depth ONLY.

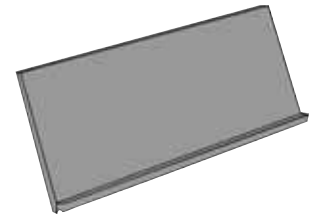

Catalog No.	Description	H x W x D	Wt. (lbs.)	Price
<u>5 Tilting Metal Shelves, 4 Flat Wood Shelves and 1 Thermally-Fused Laminate Base Shelf per Side</u>				

RP7-945-S00	D/F Starter	82" x 37-3/16" x 32"	450	\$3,771
RP8-945-S00	D/F Adder	82" x 36-3/16" x 32"	385	\$3,168

82"H Omega Tilt & Store Shelves

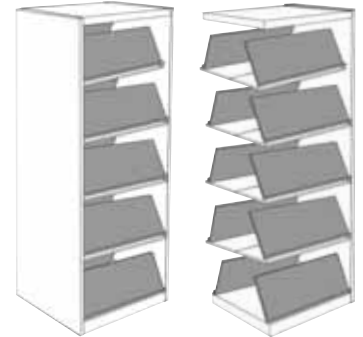

<u>4 Tilting Metal Shelves, 3 Flat Wood Shelves and 1 Thermally-Fused Laminate Base Shelf per Side</u>				
---	--	--	--	--

RP7-840-S00	D/F Starter	72" x 37-3/16" x 32"	396	\$3,578
RP8-840-S00	D/F Adder	72" x 36-3/16" x 32"	324	\$2,812

72"H Omega Tilt & Store Shelves

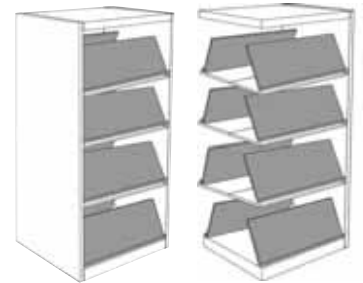

<u>3 Tilting Metal Shelves, 2 Flat Wood Shelves and 1 Thermally-Fused Laminate Base Shelf per Side</u>				
---	--	--	--	--

RP7-946-S00	D/F Starter	60-1/2" x 37-3/16" x 32"	324	\$3,383
RP8-946-S00	D/F Adder	60-1/2" x 36-3/16" x 32"	234	\$2,454

60-1/2"H Omega Tilt & Store Shelves

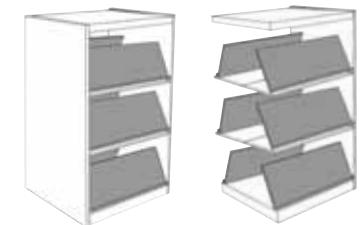

Please specify Laminate Finishes (Table 4) and Metal Color (Table 5). Details can be found on page GEN 5.

Note: Shelving Backs and Partitions are sold separately and are located in the Shelving Accessories Section on page REP 35.
Clip & Strip Shelving CANNOT be used with Omega Shelves.

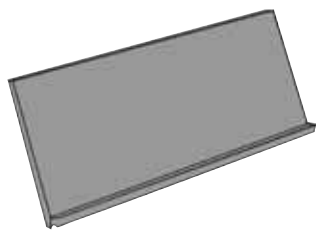

Metal Tilt and Store Shelving

Sloping display shelves have a 13"H clear display area and lift up to expose flat storage shelves via a pivot hinge. Storage space is concealed when display shelves are in normal position.

Note: Tilt and Store Shelving is available in 16" depth ONLY.

48"H Omega Tilt & Store Shelves

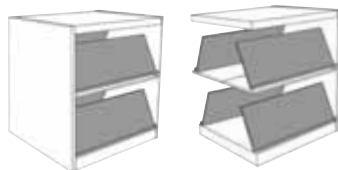

Catalog No.	Description	H x W x D	Wt. (lbs.)	Price
<i>2 Tilting Metal Shelves, 1 Flat Wood Shelves and 1 Thermally-Fused Laminate Base Shelf per Side</i>				
RP7-948-S00	D/F Starter	48" x 37-3/16" x 32"	216	\$3,018
RP8-948-S00	D/F Adder	48" x 36-3/16" x 32"	198	\$2,309

42"H Omega Tilt & Store Shelves

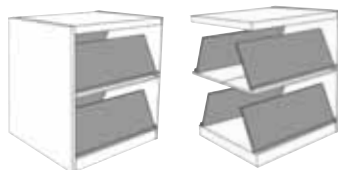

Catalog No.	Description	H x W x D	Wt. (lbs.)	Price
<i>2 Tilting Metal Shelves, 1 Flat Wood Shelves and 1 Thermally-Fused Laminate Base Shelf per Side</i>				
RP7-947-S00	D/F Starter	42" x 37-3/16" x 32"	180	\$2,653
RP8-947-S00	D/F Adder	42" x 36-3/16" x 32"	162	\$2,164

Please specify Laminate Finishes (Table 4) and Metal Color (Table 5). Details can be found on page GEN 5.

Note: Shelving Backs and Partitions are sold separately and are located in the Shelving Accessories Section on page REP 35.
Clip & Strip Shelving CANNOT be used with Omega Shelves.

Omega Picture Book Shelves, Single-Faced

Reprise Shelving

Metal Picture Book Shelving

Metal Picture Book Shelves are 11"D x 7"H overall with two metal dividers per shelf. Dividers can be placed at 26 equal spaces along the width of each shelf. A steel cotter pin is provided with each divider to prevent removal.



Catalog No.	Description	H x W x D	Wt. (lbs.)	Price
-------------	-------------	-----------	------------	-------

4 Adjustable (1 Fixed) Picture Book w/Divider Metal Shelves and 1 Thermally-Fused Laminate Base Shelf

RP1-233-S00	S/F Starter	82" x 37-3/16" x 12"	200	\$1,202
RP2-233-S00	S/F Adder	82" x 36-3/16" x 12"	163	\$880

82"H Omega Picture Book Shelves

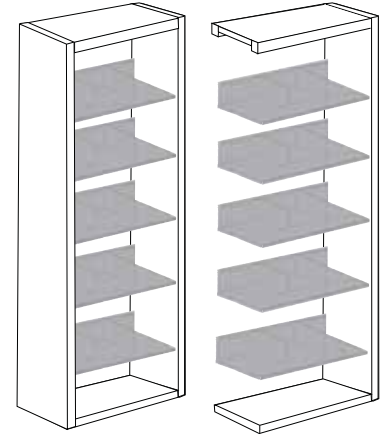

4 Adjustable Picture Book w/Divider Metal Shelves and 1 Thermally-Fused Laminate Base Shelf

RP1-237-S00	S/F Starter	72" x 37-3/16" x 12"	104	\$1,096
RP2-237-S00	S/F Adder	72" x 36-3/16" x 12"	87	\$817

72"H Omega Picture Book Shelves

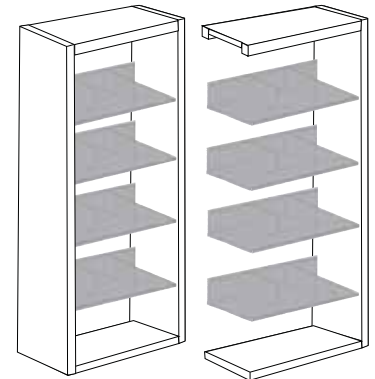

3 Adjustable Picture Book w/Divider Metal Shelves and 1 Thermally-Fused Laminate Base Shelf

RP1-232-S00	S/F Starter	60-1/2" x 37-3/16" x 12"	132	\$991
RP2-232-S00	S/F Adder	60-1/2" x 36-3/16" x 12"	105	\$753

60-1/2"H Omega Picture Book Shelves

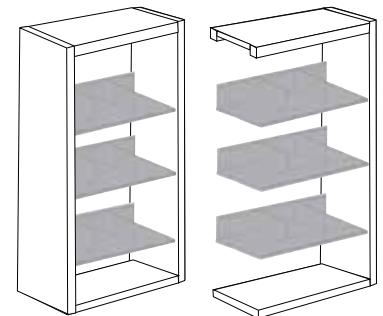

Please specify Laminate Finishes (Table 4) and Metal Color (Table 5). Details can be found on page GEN 5.

Note: Shelving Backs and Partitions are sold separately and are located in the Shelving Accessories Section on page REP 35.
Clip & Strip Shelving CANNOT be used with Omega Shelves.



Metal Picture Book Shelving

Metal Picture Book Shelves are 11"D x 7"H overall with two metal dividers per shelf. Dividers can be placed at 26 equal spaces along the width of each shelf. A steel cotter pin is provided with each divider to prevent removal.

48"H Omega Picture Book Shelves

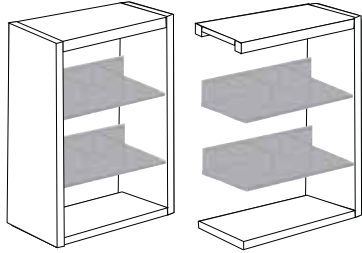

Catalog No.	Description	H x W x D	Wt. (lbs.)	Price
<u>2 Adjustable Picture Book w/Divider Metal Shelves and 1 Thermally-Fused Laminate Base Shelf</u>				
RP1-238-S00	S/F Starter	48" x 37-3/16" x 12"	79	\$808
RP2-238-S00	S/F Adder	48" x 36-3/16" x 12"	69	\$582

42"H Omega Picture Book Shelves

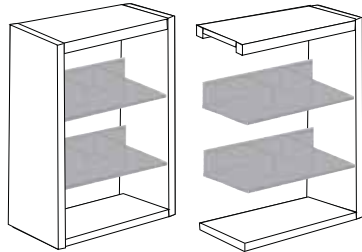

Catalog No.	Description	H x W x D	Wt. (lbs.)	Price
<u>2 Adjustable Picture Book w/Divider Metal Shelves and 1 Thermally-Fused Laminate Base Shelf</u>				
RP1-231-S00	S/F Starter	42" x 37-3/16" x 12"	78	\$760
RP2-231-S00	S/F Adder	42" x 36-3/16" x 12"	58	\$538

Please specify Laminate Finishes (Table 4) and Metal Color (Table 5). Details can be found on page GEN 5.

Note: Shelving Backs and Partitions are sold separately and are located in the Shelving Accessories Section on page REP 35.
Clip & Strip Shelving CANNOT be used with Omega Shelves.

Metal Picture Book Shelving

Metal Picture Book Shelves are 11"D x 7"H overall with two metal dividers per shelf. Dividers can be placed at 26 equal spaces along the width of each shelf. A steel cotter pin is provided with each divider to prevent removal.



Catalog No.	Description	H x W x D	Wt. (lbs.)	Price
-------------	-------------	-----------	------------	-------

4 Adjustable (1 Fixed) Picture Book w/Divider Metal Shelves and 1 Thermally-Fused Laminate Base Shelf per Side

RP1-236-S00	D/F Starter	82" x 37-3/16" x 24"	333	\$2,206
RP2-236-S00	D/F Adder	82" x 36-3/16" x 24"	269	\$1,587

82"H Omega Picture Book Shelves

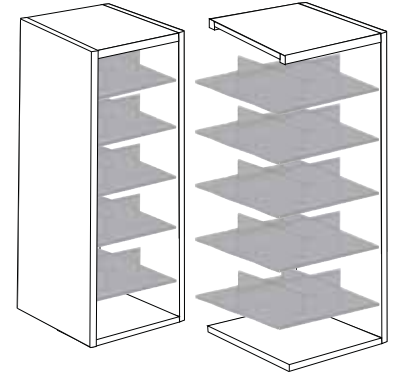

4 Adjustable Picture Book w/Divider Metal Shelves and 1 Thermally-Fused Laminate Base Shelf per Side

RP1-247-S00	D/F Starter	72" x 37-3/16" x 24"	199	\$2,058
RP2-247-S00	D/F Adder	72" x 36-3/16" x 24"	163	\$1,535

72"H Omega Picture Book Shelves

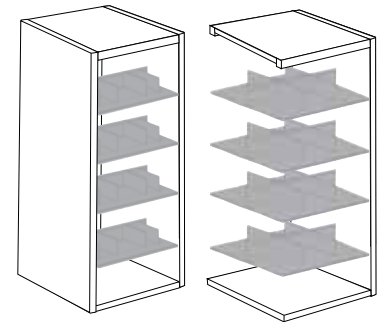

4 Adjustable Picture Book w/Divider Metal Shelves and 1 Thermally-Fused Laminate Base Shelf per Side

RP1-235-S00	D/F Starter	60-1/2" x 37-3/16" x 24"	231	\$1,910
RP2-235-S00	D/F Adder	60-1/2" x 36-3/16" x 24"	186	\$1,482

60-1/2"H Omega Picture Book Shelves

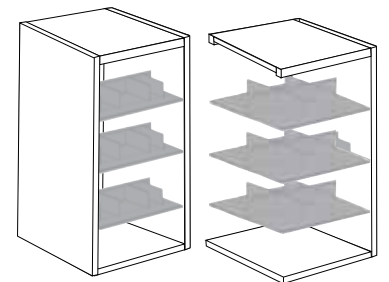

Please specify Laminate Finishes (Table 4) and Metal Color (Table 5). Details can be found on page GEN 5.

Note: Shelving Backs and Partitions are sold separately and are located in the Shelving Accessories Section on page REP 35.
Clip & Strip Shelving CANNOT be used with Omega Shelves.



Metal Picture Book Shelving

Metal Picture Book Shelves are 11"D x 7"H overall with two metal dividers per shelf. Dividers can be placed at 26 equal spaces along the width of each shelf. A steel cotter pin is provided with each divider to prevent removal.

48"H Omega Picture Book Shelves

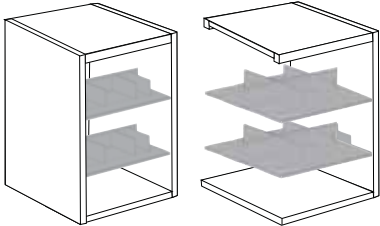

Catalog No.	Description	H x W x D	Wt. (lbs.)	Price
<u>2 Adjustable Picture Book w/Divider Metal Shelves and 1 Thermally-Fused Laminate Base Shelf per Side</u>				

RP1-248-S00	D/F Starter	48" x 37-3/16" x 24"	134	\$1,439
RP2-248-S00	D/F Adder	48" x 36-3/16" x 24"	111	\$1,079

42"H Omega Picture Book Shelves

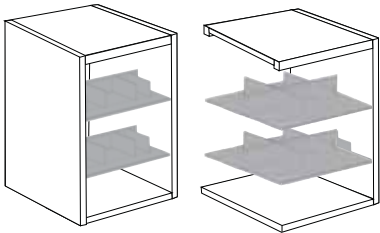

<u>2 Adjustable Picture Book w/Divider Metal Shelves and 1 Thermally-Fused Laminate Base Shelf per Side</u>				
--	--	--	--	--

RP1-234-S00	D/F Starter	42" x 37-3/16" x 24"	168	\$1,320
RP2-234-S00	D/F Adder	42" x 36-3/16" x 24"	139	\$979

Please specify Laminate Finishes (Table 4) and Metal Color (Table 5). Details can be found on page GEN 5.

Note: Shelving Backs and Partitions are sold separately and are located in the Shelving Accessories Section on page REP 35.
Clip & Strip Shelving CANNOT be used with Omega Shelves.

Casters Base



Catalog No.	Description	H x W x D	Wt. (lbs.)	Price
<i>4 Adjustable Shelves and 1 Thermally-Fused Laminate Base Shelf per Side</i>				
RP1-985-S07	D/F Starter	60-1/2" x 37-3/16" x 20"	144	\$1,901
RP1-985-S08	D/F Starter/Adder	60-1/2" x 73-3/8" x 20"	268	\$3,422
RP1-986-S07	D/F Starter	60-1/2" x 37-3/16" x 24"	190	\$2,001
RP1-986-S08	D/F Starter/Adder	60-1/2" x 73-3/8" x 24"	352	\$3,602

60-1/2"H Laminate Shelves



<i>2 Adjustable Shelves and 1 Thermally-Fused Laminate Base Shelf per Side</i>				
RP1-765-S07	D/F Starter	48" x 37-3/16" x 20"	117	\$1,499
RP1-765-S08	D/F Starter/Adder	48" x 73-3/8" x 20"	217	\$2,699
RP1-766-S07	D/F Starter	48" x 37-3/16" x 24"	154	\$1,577
RP1-766-S08	D/F Starter/Adder	48" x 73-3/8" x 24"	285	\$2,841

48"H Laminate Shelves



<i>2 Adjustable Shelves and 1 Thermally-Fused Laminate Base Shelf per Side</i>				
RP1-987-S07	D/F Starter	42" x 37-3/16" x 20"	106	\$1,399
RP1-987-S08	D/F Starter/Adder	42" x 73-3/8" x 20"	204	\$2,516
RP1-991-S07	D/F Starter	42" x 37-3/16" x 24"	140	\$1,473
RP1-991-S08	D/F Starter/Adder	42" x 73-3/8" x 24"	269	\$2,648

42"H Laminate Shelves



Please specify Wood Finish (Table 1). Details can be found on page GEN 4.
For details regarding Clip & Strip Shelving, please reference the Modifications & Up Charges Section located on page MOD 8.

Note: Partitions included for Mobile Units.



Casters Base

**60-1/2"H Laminate
Picture Book Shelves**



Catalog No.	Description	H x W x D	Wt. (lbs.)	Price
<u>2 Adjustable Picture Book w/Divider Shelves and 1 Thermally-Fused Laminate Base Shelf per Side</u>				

RP1-933-S07	D/F Starter	60-1/2" x 37-3/16" x 24"	180	\$2,101
RP1-933-S08	D/F Starter/Adder	60-1/2" x 73-3/8" x 24"	352	\$3,704

**48"H Laminate
Picture Book Shelves**



<u>1 Adjustable Picture Book w/Divider Shelves and 1 Thermally-Fused Laminate Base Shelf per Side</u>				
--	--	--	--	--

RP1-930-S07	D/F Starter	48" x 37-3/16" x 24"	149	\$1,703
RP1-930-S08	D/F Starter/Adder	48" x 73-3/8" x 24"	285	\$3,062

**42"H Laminate
Picture Book Shelves**

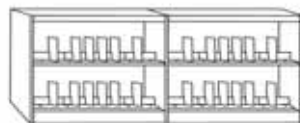

<u>1 Adjustable Picture Book w/Divider Shelves and 1 Thermally-Fused Laminate Base Shelf per Side</u>				
--	--	--	--	--

RP1-934-S07	D/F Starter	42" x 37-3/16" x 24"	130	\$1,554
RP1-934-S08	D/F Starter/Adder	42" x 73-3/8" x 24"	269	\$2,858

Please specify Wood Finish (Table 1). Details can be found on page GEN 4.

For details regarding Clip & Strip Shelving, please reference the Modifications & Up Charges Section located on page MOD 8.

Note: Partitions included for Mobile Units.

Casters Base



Catalog No.	Description	H x W x D	Wt. (lbs.)	Price
<u>4 Adjustable Metal Shelves and 1 Thermally-Fused Laminate Base Shelf per Side</u>				
RP5-985-S07	D/F Starter	60-1/2" x 37-3/16" x 20"	144	\$2,048
RP5-985-S08	D/F Starter/Adder	60-1/2" x 73-3/8" x 20"	268	\$3,685
RP5-986-S07	D/F Starter	60-1/2" x 37-3/16" x 24"	190	\$2,090
RP5-986-S08	D/F Starter/Adder	60-1/2" x 73-3/8" x 24"	352	\$3,761

60-1/2"H Omega Shelves



2 Adjustable Metal Shelves and 1 Thermally-Fused Laminate Base Shelf per Side

RP5-765-S07	D/F Starter	48" x 37-3/16" x 20"	117	\$1,615
RP5-765-S08	D/F Starter/Adder	48" x 73-3/8" x 20"	217	\$2,907
RP5-766-S07	D/F Starter	48" x 37-3/16" x 24"	154	\$1,647
RP5-766-S08	D/F Starter/Adder	48" x 73-3/8" x 24"	285	\$2,967

48"H Omega Shelves

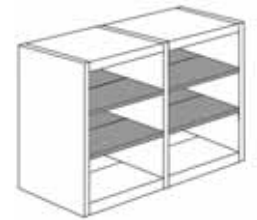

2 Adjustable Metal Shelves and 1 Thermally-Fused Laminate Base Shelf per Side

RP5-987-S07	D/F Starter	42" x 37-3/16" x 20"	106	\$1,506
RP5-987-S08	D/F Starter/Adder	42" x 73-3/8" x 20"	204	\$2,710
RP5-991-S07	D/F Starter	42" x 37-3/16" x 24"	140	\$1,538
RP5-991-S08	D/F Starter/Adder	42" x 73-3/8" x 24"	269	\$2,765

42"H Omega Shelves

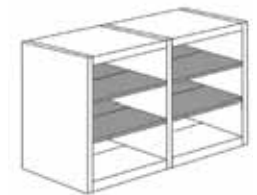

Please specify Laminate Finishes (Table 4) and Metal Color (Table 5). Details can be found on page GEN 5.

Note: Clip & Strip Shelving CANNOT be used with Omega Shelves.
Partitions included for Mobile Units.



Casters Base

60-1/2"H Omega Book Stop Shelves



Catalog No.	Description	H x W x D	Wt. (lbs.)	Price
<u>4 Adjustable Metal Shelves and 1 Metal Base Shelf per Side</u>				
RP7-985-S07	D/F Starter	60-1/2" x 37-3/16" x 20"	144	\$2,505
RP7-985-S08	D/F Starter/Adder	60-1/2" x 73-3/8" x 20"	268	\$4,400
RP7-986-S07	D/F Starter	60-1/2" x 37-3/16" x 24"	190	\$2,566
RP7-986-S08	D/F Starter/Adder	60-1/2" x 73-3/8" x 24"	352	\$4,475

48"H Omega Book Stop Shelves

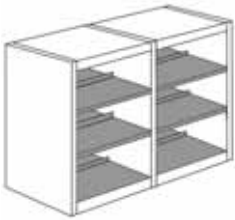

Catalog No.	Description	H x W x D	Wt. (lbs.)	Price
<u>2 Adjustable Metal Shelves and 1 Metal Base Shelf per Side</u>				
RP7-765-S07	D/F Starter	48" x 37-3/16" x 20"	117	\$1,843
RP7-765-S08	D/F Starter/Adder	48" x 73-3/8" x 20"	217	\$3,179
RP7-766-S07	D/F Starter	48" x 37-3/16" x 24"	154	\$1,941
RP7-766-S08	D/F Starter/Adder	48" x 73-3/8" x 24"	285	\$3,346

42"H Omega Book Stop Shelves

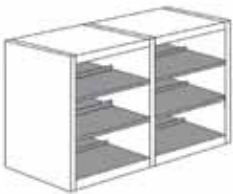

Catalog No.	Description	H x W x D	Wt. (lbs.)	Price
<u>2 Adjustable Metal Shelves and 1 Metal Base Shelf per Side</u>				
RP7-987-S07	D/F Starter	42" x 37-3/16" x 20"	106	\$1,660
RP7-987-S08	D/F Starter/Adder	42" x 73-3/8" x 20"	204	\$2,975
RP7-991-S07	D/F Starter	42" x 37-3/16" x 24"	140	\$1,747
RP7-991-S08	D/F Starter/Adder	42" x 73-3/8" x 24"	269	\$3,132

Please specify Laminate Finishes (Table 4) and Metal Color (Table 5). Details can be found on page GEN 5.

Note: Clip & Strip Shelving CANNOT be used with Omega Shelves. Shelving Backs and Partitions CANNOT be used with Book Stop Shelving. Sway Braces included.

Shelving Backs

Except where specified, all single-faced shelving is supplied without backs. When specified, single-faced shelving is supplied with full-height and full-width 1/4" thick thermally-fused laminate panel. Backs Partitions fit into rabbets in the end panels, intermediates, tops, and base, so that edges are concealed from view after installation.

Shelving Partitions

Except where specified, all double-faced shelving is supplied without partitions. When specified, double-faced shelving is supplied with full-height and full-width 1/4" thick thermally-fused laminate panel. Partitions fit into rabbets in the end panels, intermediates, tops, and base, so that edges are concealed from view after installation.

Catalog No.	Description	H x W x D	Wt. (lbs.)	Price	
RPB-608-S00	Back/Partition, 90"H	87-5/16" x 35-5/8" x 1/4"	24	\$180	<div data-bbox="1312 541 1576 569" data-label="Text"> <p>Shelving Backs/Partitions</p> </div> <div data-bbox="1398 617 1528 842" data-label="Image"> </div>
RPB-600-S00	Back/Partition, 82"H	79-5/16" x 35-5/8" x 1/4"	22	\$174	
RPB-620-S00	Back/Partition, 72"H	69-5/16" x 35-5/8" x 1/4"	20	\$162	
RPB-602-S00	Back/Partition, 60-1/2"H	58-15/16" x 35-5/8" x 1/4"	18	\$150	
RPB-606-S00	Back/Partition, 48"H	46-7/16" x 35-5/8" x 1/4"	15	\$111	
RPB-604-S00	Back/Partition, 42"H	40-7/16" x 35-5/8" x 1/4"	12	\$102	

Please specify Laminate Finishes (Table 4). Details can be found on page GEN 5.

External Edge Banding

Single-Faced Tops are banded on both ends and on the front edge only. Back edge is not banded.
Double-Faced Tops are banded on both ends and on the front and back edges.

Catalog No.	Description	Wt. (lbs.)	Price
<i>To Cover ONE UNIT</i>			
RP-W10-S01	10"D, Single-Faced	11	\$118
RP-W12-S01	12"D, Single-Faced	14	\$122
RP-W20-S01	20"D, Double-Faced	23	\$176
RP-W24-S01	24"D, Double-Faced	27	\$199
<i>To Cover TWO UNITS</i>			
RP-W10-S02	10"D, Single-Faced	22	\$165
RP-W12-S02	12"D, Single-Faced	28	\$175
RP-W20-S02	20"D, Double-Faced	46	\$248
RP-W24-S02	24"D, Double-Faced	54	\$312
<i>To Cover THREE UNITS</i>			
RP-W10-S03	10"D, Single-Faced	33	\$221
RP-W12-S03	12"D, Single-Faced	42	\$231
RP-W20-S03	20"D, Double-Faced	69	\$314
RP-W24-S03	24"D, Double-Faced	81	\$330
<i>To Cover FOUR UNITS</i>			
RP-W10-S04	10"D, Single-Faced	44	\$329
RP-W12-S04	12"D, Single-Faced	56	\$349
RP-W20-S04	20"D, Double-Faced	92	\$491
RP-W24-S04	24"D, Double-Faced	108	\$528
<i>To Cover FIVE UNITS</i>			
RP-W10-S05	10"D, Single-Faced	55	\$381
RP-W12-S05	12"D, Single-Faced	70	\$407
RP-W20-S05	20"D, Double-Faced	115	\$562
RP-W24-S05	24"D, Double-Faced	135	\$642
<i>To Cover SIX UNITS</i>			
RP-W10-S06	10"D, Single-Faced	66	\$430
RP-W12-S06	12"D, Single-Faced	84	\$461
RP-W20-S06	20"D, Double-Faced	138	\$626
RP-W24-S06	24"D, Double-Faced	162	\$660
<i>To Cover SEVEN UNITS</i>			
RP-W10-S07	10"D, Single-Faced	77	\$546
RP-W12-S07	12"D, Single-Faced	98	\$580
RP-W20-S07	20"D, Double-Faced	161	\$803
RP-W24-S07	24"D, Double-Faced	189	\$859
<i>To Cover EIGHT UNITS</i>			
RP-W10-S08	10"D, Single-Faced	88	\$595
RP-W12-S08	12"D, Single-Faced	112	\$635
RP-W20-S08	20"D, Double-Faced	184	\$875
RP-W24-S08	24"D, Double-Faced	216	\$974
<i>To Cover NINE UNITS</i>			
RP-W10-S09	10"D, Single-Faced	99	\$645
RP-W12-S09	12"D, Single-Faced	126	\$691
RP-W20-S09	20"D, Double-Faced	207	\$941
RP-W24-S09	24"D, Double-Faced	243	\$990

Please specify Laminate Finishes (Table 4). Details can be found on page GEN 5.

Seating



2017 Price List and Specifications Addendum

Brodart Co. Contract Furniture - Made in USA

280 North Road, Clinton County Industrial Park • McElhattan, PA 17748

Toll-Free: 888-521-1884 • E-Mail: furniture@brodart.com • www.brodartfurniture.com

General Specifications

CHAIR FRAME

The chair frame is constructed of 16-gauge steel tubing. All joints are mig welded. The front and back legs are 1-3/4" diameter, and the side and front stretchers are 1-1/2" x 3/4" rectangular tubing. The framing includes four metal brackets attached to the seat. The legs are equipped with rubber-cushioned glides.

CHAIR SEAT

Chair seats are 5/8" thick bent multi-ply faced with maple or rift-cut red oak as specified.

UPHOLSTERED SEAT

Upholstered seats receive 1-1/2" thick HR-55, 2.8 density 55 ILD foam prior to being covered by a selected upholstery material that is wrapped around and stapled to the underside of the seat panel.

WOOD CHAIR BACKS

Chair backs are 5/8" thick, bent multi-ply faced with maple or rift-cut red oak as specified. Adult backs are 10"H x 19-1/2"W. Youth backs are 8"H x 15-1/2"W.

UPHOLSTERED CHAIR BACKS

Upholstered chair backs have a back platen of curved plywood and receive 1" thick 1835 FR, 1.8 density, 35 ILD foam prior to being covered by a selected upholstery material that is wrapped around and stapled to the back of the platen. This upholstered back platen is then screwed to the wood back from the rear support.

UPHOLSTERY MATERIALS AND FABRICS

Brodart fabric selections and polyurethane foam are fire rated.

Fabrics which meet Calif. Technical Bulletin #133 are available.

GLIDES

Each chair leg is equipped with a 7/8" diameter rubber-cushioned glide.

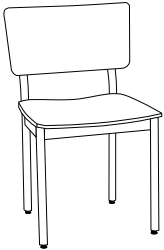
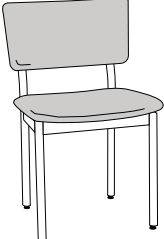
	Catalog No.	Description	Seat H x W x D	Wt. (lbs.)	COM Price	Wood/G1 Price	Grade 2 Price	Grade 3 Price	Grade 4 Price	Grade 5 Price
Wood Seat/Back Chair 	<u>Wood Seat and Back with Metal Frame Chair, Oak Wood</u>									
	AP2-571-S00	32-1/2"H Adult	18-1/2" x 20-1/2" x 17"	25		\$718				
	AP2-561-S00	28-3/4"H Youth	16-1/2" x 17-1/2" x 15"	25		\$718				
	<u>Wood Seat and Back with Metal Frame Chair, Maple Wood</u>									
	AP2-571-SMA	32-1/2"H Adult	18-1/2" x 20-1/2" x 17"	25		\$775				
	AP2-561-SMA	28-3/4"H Youth	16-1/2" x 17-1/2" x 15"	25		\$775				
Upholstered Seat/Back Chair 	<u>Upholstered Seat and Back with Metal Frame Chair, Oak Wood</u>									
	AP2-574-S00	32-1/2"H Adult	18-1/2" x 20-1/2" x 17"	25	\$818	\$816	\$1,020	\$1,052	\$1,191	\$1,261
	AP2-564-S00	28-3/4"H Youth	16-1/2" x 17-1/2" x 15"	25	\$762	\$761	\$950	\$982	\$1,112	\$1,174
	<u>Upholstered Seat and Back with Metal Frame Chair, Maple Wood</u>									
	AP2-574-SMA	32-1/2"H Adult	18-1/2" x 20-1/2" x 17"	25	\$891	\$890	\$1,113	\$1,148	\$1,301	\$1,374
	AP2-564-SMA	28-3/4"H Youth	16-1/2" x 17-1/2" x 15"	25	\$830	\$828	\$1,037	\$1,068	\$1,208	\$1,279

Fabric Requirements: 1-1/2 yards per chair, Non-directional, 54" wide.

Please specify Wood Finish (Table 1), Metal Color (Table 3) and Upholstery; if applicable (Table 5). Details can be found on pages GEN 4 and GEN 5.

General Specifications

CHAIR FRAME

Chair frame is 36" overall height and 18-5/8" overall width. The legs are 1-3/4" square. The back legs receive a 10° angle beginning at the top of the seat. Lower support stretcher braces will be positioned between the front and back leg 9" from the bottom and will be 1"H x 3/4" thick. There are two (2) horizontal stretchers between the support braces that measure 3/4"H x 1" thick. Seat rails are 1-1/4" x 1" thick. All joints shall be mortised, tenoned, and glued. All vertical and horizontal edges are eased.

CHAIR SEAT – WOOD

The wood seat is scooped solid wood, 1" thick, 19"W, 19"D, with notches cut in the two (2) back corners to fit around the back legs.

CHAIR SEAT - UPHOLSTERED

The chair seat is 3/4" thick plywood covered with 1-1/2" thick foam and covered with a selected upholstery material which will be wrapped around and stapled to the underside of the seat. The underside of the seat is covered with a black cambric material.

Brodart fabric selections and polyurethane foam are fire rated.

Fabrics which meet Calif. Technical Bulletin #133 are available.

CHAIR BACKS

The seat backs are 16-gauge metal, curved to fit the contour of the top back rail of the chair which is solid wood, 1-1/4"H x 1" thick and curved at a 30" radius. The backs are attached to the chair using finished wood screws. The metal is available in 5 different laser cut patterns which are electrostatic powder painted with no bare metal or sharp edges.

CHAIR ARMS

The arm is 1-3/4" square. The arm is attached 2" back from the front of the arm to a J-shaped vertical arm support that is 1-3/4" square. Vertical arm support is attached to the side seat rail with a wood lag bolt and fastened with a washer and nut. The arm is attached to the back post with a wood screw. Screw head is counter-sunk and capped with a wooden cover and sanded flush.

CHAIR GLIDES

Each chair leg is equipped with a 7/8" diameter rubber cushioned nail glide. This chair has passed the ANSI/BIFMA X5.1-2002 Type III test.

METAL BACK DESIGNS

When ordered, one of the following back designs must be specified as part of the catalog number. I.e.: an All Wood Adult Height chair in Oak wood and with the "Horizontal Slat" back design would be BBH-551-S00

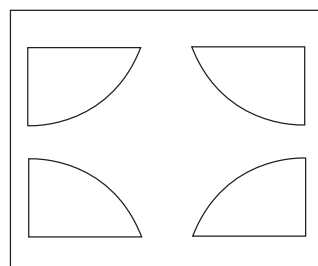

Q - QUARTER CIRCLE

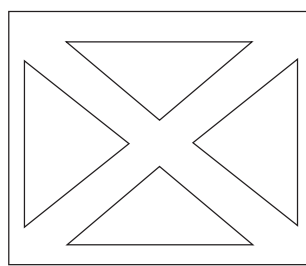

T - TRIANGLES

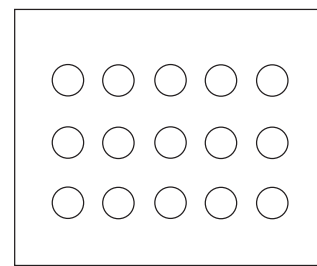

C - CIRCLES

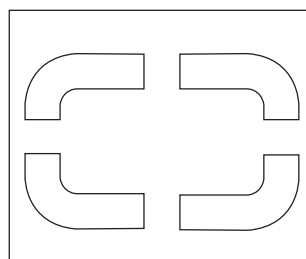

P - PICTURE FRAME

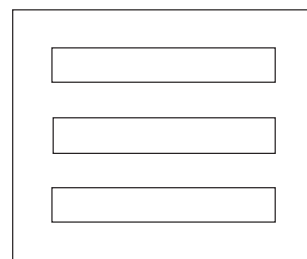

H - HORIZONTAL SLATS

When ordered, one of the following back designs must be specified as part of the catalog number. Example: an All Wood Adult Height chair in Oak wood with the "Horizontal Slats" back design would be **BBH 551 S00**.

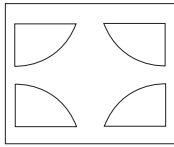

Q - QUARTER CIRCLE

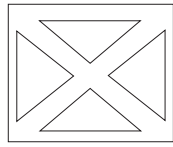

T - TRIANGLES

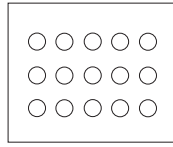

C - CIRCLES

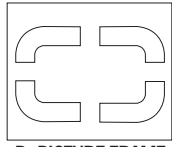

P - PICTURE FRAME

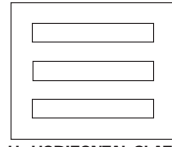

H - HORIZONTAL SLATS

All Wood Chair without Arms

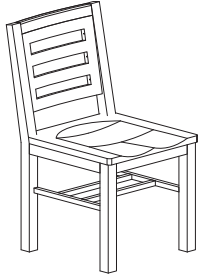

All Wood Chair, Oak Wood

Catalog No.	Description	Seat H x W x D	Wt. (lbs.)	COM Price	Wood/G1 Price	Grade 2 Price	Grade 3 Price	Grade 4 Price	Grade 5 Price
BB_-551-S00 OAK	32-1/2"H Adult	18" x 19" x 19"	22		\$876				
BB_-561-S00 OAK	28-3/4"H Youth	16" x 19" x 19"	21		\$876				

All Wood Chair, Maple Wood

BB_-551-S00 MAP	32-1/2"H Adult	18" x 19" x 19"	22		\$876				
BB_-561-S00 MAP	28-3/4"H Youth	16" x 19" x 19"	21		\$876				

Upholstered Seat Chair without Arms

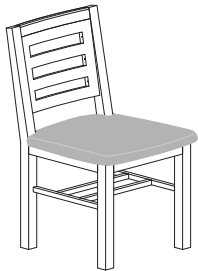

Wood Framed Chair with Upholstered Seat, Oak Wood

BB_-552-S00 OAK	32-1/2"H Adult	18" x 19" x 19"	22	\$1,002	\$997	\$1,201	\$1,241	\$1,455	\$1,540
BB_-562-S00 OAK	28-3/4"H Youth	16" x 19" x 19"	21	\$1,002	\$997	\$1,201	\$1,241	\$1,455	\$1,540

Wood Framed Chair with Upholstered Seat, Maple Wood

BB_-552-S00 MAP	32-1/2"H Adult	18" x 19" x 19"	22	\$1,002	\$997	\$1,201	\$1,241	\$1,455	\$1,540
BB_-562-S00 MAP	28-3/4"H Youth	16" x 19" x 19"	21	\$1,002	\$997	\$1,201	\$1,241	\$1,455	\$1,540

Fabric Requirements: 1/2 yards per chair, Non-directional, 54" wide.

All Wood Chair with Arms



All Wood Chair with Arms (Arm Height: 26-3/8" Adult, 24-3/8" Youth), Oak Wood

BB_-581-S00 OAK	32-1/2"H Adult	18" x 19" x 19"	28		\$1,002				
BB_-591-S00 OAK	28-3/4"H Youth	16" x 19" x 19"	27		\$1,002				

All Wood Chair with Arms (Arm Height: 26-3/8" Adult, 24-3/8" Youth), Maple Wood

BB_-581-S00 MAP	32-1/2"H Adult	18" x 19" x 19"	28		\$1,002				
BB_-591-S00 MAP	28-3/4"H Youth	16" x 19" x 19"	27		\$1,002				

Upholstered Seat Chair with Arms



Wood Framed Chair with Upholstered Seat and Arms (Arm Height: 26-3/8" Adult, 24-3/8" Youth), Oak Wood

BB_-582-S00 OAK	32-1/2"H Adult	18" x 19" x 19"	28	\$1,114	\$1,110	\$1,336	\$1,382	\$1,619	\$1,712
BB_-592-S00 OAK	28-3/4"H Youth	16" x 19" x 19"	27	\$1,114	\$1,110	\$1,336	\$1,382	\$1,619	\$1,712

Wood Framed Chair with Upholstered Seat and Arms (Arm Height: 26-3/8" Adult, 24-3/8" Youth), Maple Wood

BB_-582-S00 MAP	32-1/2"H Adult	18" x 19" x 19"	28	\$1,114	\$1,110	\$1,336	\$1,382	\$1,619	\$1,712
BB_-592-S00 MAP	28-3/4"H Youth	16" x 19" x 19"	27	\$1,114	\$1,110	\$1,336	\$1,382	\$1,619	\$1,712

Fabric Requirements: 1/2 yards per chair, Non-directional, 54" wide.

Please specify Wood Finish (Table 1), Upholstery; if applicable (Table 5) and Back Design (Above). Details can be found on pages GEN 4 and GEN 5.

General Specifications

CHAIR FRAMES

Each frame member is constructed from 1-1/4" hardwood. All frame joints are mortised, tenoned and glued. Legs, back posts, and stretchers are 1" x 2-3/16"W. Upper side rail is 1" x 3"W; lower side rail is 1" x 2-3/16"W. Front and back top rails are 1" x 2-1/2" shaped to receive seat. Tops of front and rear vertical post in side frames have a 3/4" radius, and the bottom of each leg receives a 3/4" radius. Front and back legs are coped with a 7/8" radius on the two outside edges. The top of the side seat rails, the top of the side stretchers and the top of the cross stretchers are also coped with a 7/8" radius.

All frames have a 3/4" solid hardwood support brace in each corner of the seat area to give added strength.

CHAIR SEAT

Standard adult wood seats are 3/4" thick, bent-plywood panel, faced with select hardwood veneers. Standard youth and juvenile wood seats are 1/2" thick bent plywood panel, faced with select hardwood veneers.

Note: Optional 3/4" thick, hardwood seats, (available at extra charge), are constructed of glued-up strips not less than 1" or more than 3"W. Seat panels are scooped for seating comfort.

Upholstered seats are constructed of 1/2" formed plywood. The plywood is covered with 2" thick foam prior to being covered by a selected upholstery material which is wrapped around and stapled to the underside of seat. The underside of the seat is covered with black cambric material.

CHAIR BACK

Chair back is 1" x 5" (youth & juvenile) or 6" H (adult) steam-bent, solid hardwood, screwed into vertical back posts on an 8 $\frac{1}{2}$ angle using four 2" joint connector bolts. Upholstered backs have a back platen which is curved plywood; prior to upholstery two tee-nuts are inserted into the platen. The platen is covered with 1" foam padding and upholstered with all edges wrapped and stapled to the back side of the platen. Upholstered platens are attached to the chair back by two machine bolts which pass through the solid chair back into the tee-nuts in the platen.

UPHOLSTERY MATERIALS AND FABRICS

Brodart fabric selections and polyurethane foam are fire rated.

Fabrics which meet Calif. Technical Bulletin #133 are available.

GLIDES

Leg base chairs are equipped with rubber-cushioned glides.

SLED BASE CHAIRS

Sled base chairs are of the same construction as leg base chairs but receive two 1" x 2-3/16" rails tenoned and glued to the bottom of leg post to form a sled base. Sled base chairs do not receive glides.

Catalog No.	Description	Seat H x W x D	Wt. (lbs.)	COM Price	Wood/G1 Price	Grade 2 Price	Grade 3 Price	Grade 4 Price	Grade 5 Price
All Wood Chair									
<i>All Wood Chair with Plywood Seat, Oak Wood</i>									
B1-551-S00 OAK	32-3/8"H Adult	18" x 18-3/4" x 18"	23		\$362				
B1-561-S00 OAK	27-3/8"H Youth	16" x 16" x 16"	23		\$362				
B1-541-S00 OAK	25-3/8"H Juvenile	14" x 16" x 16"	22		\$362				
<i>All Wood Chair with Plywood Seat, Maple Wood</i>									
B1-551-S00 MAP	32-3/8"H Adult	18" x 18-3/4" x 18"	23		\$384				
B1-561-S00 MAP	27-3/8"H Youth	16" x 16" x 16"	23		\$384				
B1-541-S00 MAP	25-3/8"H Juvenile	14" x 16" x 16"	22		\$384				
<i>All Wood Chair with Solid (Saddle) Seat, Oak Wood</i>									
B1-551-OAK	32-3/8"H Adult	18" x 18-3/4" x 18"	23		\$383				
B1-561-OAK	27-3/8"H Youth	16" x 16" x 16"	23		\$383				
B1-541-OAK	25-3/8"H Juvenile	14" x 16" x 16"	22		\$383				
<i>All Wood Chair with Solid (Saddle) Seat, Maple Wood</i>									
B1-551-OAK MAP	32-3/8"H Adult	18" x 18-3/4" x 18"	23		\$406				
B1-561-OAK MAP	27-3/8"H Youth	16" x 16" x 16"	23		\$406				
B1-541-OAK MAP	25-3/8"H Juvenile	14" x 16" x 16"	22		\$406				

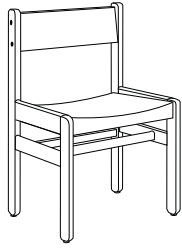

Upholstered Back Chair									
<i>Wood Frame Chair with Upholstered Back and Plywood Seat, Oak Wood</i>									
B1-553-S00 OAK	32-3/8"H Adult	18" x 18-3/4" x 18"	23	\$413	\$412	\$433	\$448	\$601	\$635
B1-563-S00 OAK	27-3/8"H Youth	16" x 16" x 16"	23	\$413	\$412	\$433	\$448	\$601	\$635
B1-543-S00 OAK	25-3/8"H Juvenile	14" x 16" x 16"	22	\$413	\$412	\$433	\$448	\$601	\$635
<i>Wood Frame Chair with Upholstered Back and Plywood Seat, Maple Wood</i>									
B1-553-S00 MAP	32-3/8"H Adult	18" x 18-3/4" x 18"	23	\$438	\$437	\$458	\$475	\$638	\$675
B1-563-S00 MAP	27-3/8"H Youth	16" x 16" x 16"	23	\$438	\$437	\$458	\$475	\$638	\$675
B1-543-S00 MAP	25-3/8"H Juvenile	14" x 16" x 16"	22	\$438	\$437	\$458	\$475	\$638	\$675
<i>Wood Frame Chair with Upholstered Back and Solid (Saddle) Seat, Oak Wood</i>									
B1-553-OAK	32-3/8"H Adult	18" x 18-3/4" x 18"	23	\$430	\$429	\$451	\$469	\$626	\$662
B1-563-OAK	27-3/8"H Youth	16" x 16" x 16"	23	\$430	\$429	\$451	\$469	\$626	\$662
B1-543-OAK	25-3/8"H Juvenile	14" x 16" x 16"	22	\$430	\$429	\$451	\$469	\$626	\$662
<i>Wood Frame Chair with Upholstered Back and Solid (Saddle) Seat, Maple Wood</i>									
B1-553-OAK MAP	32-3/8"H Adult	18" x 18-3/4" x 18"	23	\$456	\$455	\$478	\$496	\$665	\$703
B1-563-OAK MAP	27-3/8"H Youth	16" x 16" x 16"	23	\$456	\$455	\$478	\$496	\$665	\$703
B1-543-OAK MAP	25-3/8"H Juvenile	14" x 16" x 16"	22	\$456	\$455	\$478	\$496	\$665	\$703

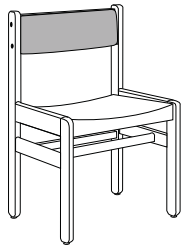

Fabric Requirements: Back 1/4 yards and Seat 1/2 yards per chair, Non-directional, 54" wide.

Please specify Wood Finish (Table 1) and Upholstery; if applicable (Table 5). Details can be found on pages GEN 4 and GEN 5.

Catalog No.	Description	Seat H x W x D	Wt. (lbs.)	COM Price	Wood/G1 Price	Grade 2 Price	Grade 3 Price	Grade 4 Price	Grade 5 Price
<u>Wood Frame Chair with Upholstered Seat, Oak Wood</u>									
B1-552-S00 OAK	32-3/8"H Adult	18" x 18-3/4" x 18"	23	\$425	\$421	\$475	\$493	\$614	\$650
B1-562-S00 OAK	27-3/8"H Youth	16" x 16" x 16"	23	\$425	\$421	\$475	\$493	\$614	\$650
B1-542-S00 OAK	25-3/8"H Juvenile	14" x 16" x 16"	22	\$425	\$421	\$475	\$493	\$614	\$650
<u>Wood Frame Chair with Upholstered Seat, Maple Wood</u>									
B1-552-S00 MAP	32-3/8"H Adult	18" x 18-3/4" x 18"	23	\$451	\$447	\$504	\$523	\$651	\$689
B1-562-S00 MAP	27-3/8"H Youth	16" x 16" x 16"	23	\$451	\$447	\$504	\$523	\$651	\$689
B1-542-S00 MAP	25-3/8"H Juvenile	14" x 16" x 16"	22	\$451	\$447	\$504	\$523	\$651	\$689



<u>Wood Frame Chair with Upholstered Seat and Back, Oak Wood</u>									
B1-554-S00 OAK	32-3/8"H Adult	18" x 18-3/4" x 18"	23	\$488	\$479	\$601	\$619	\$701	\$741
B1-564-S00 OAK	27-3/8"H Youth	16" x 16" x 16"	23	\$488	\$479	\$601	\$619	\$701	\$741
B1-544-S00 OAK	25-3/8"H Juvenile	14" x 16" x 16"	22	\$488	\$479	\$601	\$619	\$701	\$741
<u>Wood Frame Chair with Upholstered Seat and Back, Maple Wood</u>									
B1-554-S00 MAP	32-3/8"H Adult	18" x 18-3/4" x 18"	23	\$517	\$509	\$638	\$657	\$743	\$786
B1-564-S00 MAP	27-3/8"H Youth	16" x 16" x 16"	23	\$517	\$509	\$638	\$657	\$743	\$786
B1-544-S00 MAP	25-3/8"H Juvenile	14" x 16" x 16"	22	\$517	\$509	\$638	\$657	\$743	\$786

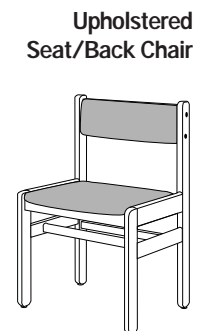

Fabric Requirements: Back 1/4 yards and Seat 1/2 yards per chair, Non-directional, 54" wide.

Please specify Wood Finish (Table 1) and Upholstery; if applicable (Table 5). Details can be found on pages GEN 4 and GEN 5.

Catalog No.	Description	Seat H x W x D	Wt. (lbs.)	COM Price	Wood/G1 Price	Grade 2 Price	Grade 3 Price	Grade 4 Price	Grade 5 Price
All Wood Chair									
<i>All Wood Chair with Plywood Seat, Oak Wood</i>									
B2-551-S00 OAK	32"H Adult	18" x 18-3/4" x 18"	23		\$362				
B2-561-S00 OAK	27"H Youth	16" x 16" x 16"	23		\$362				
B2-541-S00 OAK	25"H Juvenile	14" x 16" x 16"	22		\$362				
<i>All Wood Chair with Plywood Seat, Maple Wood</i>									
B2-551-S00 MAP	32"H Adult	18" x 18-3/4" x 18"	23		\$384				
B2-561-S00 MAP	27"H Youth	16" x 16" x 16"	23		\$384				
B2-541-S00 MAP	25"H Juvenile	14" x 16" x 16"	22		\$384				
<i>All Wood Chair with Solid (Saddle) Seat, Oak Wood</i>									
B2-551-OAK	32"H Adult	18" x 18-3/4" x 18"	23		\$383				
B2-561-OAK	27"H Youth	16" x 16" x 16"	23		\$383				
B2-541-OAK	25"H Juvenile	14" x 16" x 16"	22		\$383				
<i>All Wood Chair with Solid (Saddle) Seat, Maple Wood</i>									
B2-551-OAK MAP	32"H Adult	18" x 18-3/4" x 18"	23		\$406				
B2-561-OAK MAP	27"H Youth	16" x 16" x 16"	23		\$406				
B2-541-OAK MAP	25"H Juvenile	14" x 16" x 16"	22		\$406				

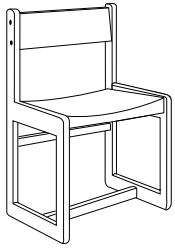

Upholstered Back Chair									
<i>Wood Frame Chair with Upholstered Back and Plywood Seat, Oak Wood</i>									
B2-553-S00 OAK	32"H Adult	18" x 18-3/4" x 18"	23	\$413	\$412	\$433	\$448	\$601	\$635
B2-563-S00 OAK	27"H Youth	16" x 16" x 16"	23	\$413	\$412	\$433	\$448	\$601	\$635
B2-543-S00 OAK	25"H Juvenile	14" x 16" x 16"	22	\$413	\$412	\$433	\$448	\$601	\$635
<i>Wood Frame Chair with Upholstered Back and Plywood Seat, Maple Wood</i>									
B2-553-S00 MAP	32"H Adult	18" x 18-3/4" x 18"	23	\$438	\$437	\$458	\$475	\$638	\$675
B2-563-S00 MAP	27"H Youth	16" x 16" x 16"	23	\$438	\$437	\$458	\$475	\$638	\$675
B2-543-S00 MAP	25"H Juvenile	14" x 16" x 16"	22	\$438	\$437	\$458	\$475	\$638	\$675
<i>Wood Frame Chair with Upholstered Back and Solid (Saddle) Seat, Oak Wood</i>									
B2-553-OAK	32"H Adult	18" x 18-3/4" x 18"	23	\$430	\$429	\$451	\$469	\$626	\$662
B2-563-OAK	27"H Youth	16" x 16" x 16"	23	\$430	\$429	\$451	\$469	\$626	\$662
B2-543-OAK	25"H Juvenile	14" x 16" x 16"	22	\$430	\$429	\$451	\$469	\$626	\$662
<i>Wood Frame Chair with Upholstered Back and Solid (Saddle) Seat, Maple Wood</i>									
B2-553-OAK MAP	32"H Adult	18" x 18-3/4" x 18"	23	\$456	\$455	\$478	\$496	\$665	\$703
B2-563-OAK MAP	27"H Youth	16" x 16" x 16"	23	\$456	\$455	\$478	\$496	\$665	\$703
B2-543-OAK MAP	25"H Juvenile	14" x 16" x 16"	22	\$456	\$455	\$478	\$496	\$665	\$703

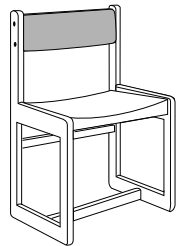

Fabric Requirements: Back 1/4 yards and Seat 1/2 yards per chair, Non-directional, 54" wide.

Please specify Wood Finish (Table 1) and Upholstery; if applicable (Table 5). Details can be found on pages GEN 4 and GEN 5.

Catalog No.	Description	Seat H x W x D	Wt. (lbs.)	COM Price	Wood/G1 Price	Grade 2 Price	Grade 3 Price	Grade 4 Price	Grade 5 Price
<u>Wood Frame Chair with Upholstered Seat, Oak Wood</u>									
B2-552-S00 OAK	32"H Adult	18" x 18-3/4" x 18"	23	\$425	\$421	\$475	\$493	\$614	\$650
B2-562-S00 OAK	27"H Youth	16" x 16" x 16"	23	\$425	\$421	\$475	\$493	\$614	\$650
B2-542-S00 OAK	25"H Juvenile	14" x 16" x 16"	22	\$425	\$421	\$475	\$493	\$614	\$650
<u>Wood Frame Chair with Upholstered Seat, Maple Wood</u>									
B2-552-S00 MAP	32"H Adult	18" x 18-3/4" x 18"	23	\$451	\$447	\$504	\$523	\$651	\$689
B2-562-S00 MAP	27"H Youth	16" x 16" x 16"	23	\$451	\$447	\$504	\$523	\$651	\$689
B2-542-S00 MAP	25"H Juvenile	14" x 16" x 16"	22	\$451	\$447	\$504	\$523	\$651	\$689



<u>Wood Frame Chair with Upholstered Seat and Back, Oak Wood</u>									
B2-554-S00 OAK	32"H Adult	18" x 18-3/4" x 18"	23	\$488	\$479	\$601	\$619	\$701	\$741
B2-564-S00 OAK	27"H Youth	16" x 16" x 16"	23	\$488	\$479	\$601	\$619	\$701	\$741
B2-544-S00 OAK	25"H Juvenile	14" x 16" x 16"	22	\$488	\$479	\$601	\$619	\$701	\$741
<u>Wood Frame Chair with Upholstered Seat and Back, Maple Wood</u>									
B2-554-S00 MAP	32"H Adult	18" x 18-3/4" x 18"	23	\$517	\$509	\$638	\$657	\$743	\$786
B2-564-S00 MAP	27"H Youth	16" x 16" x 16"	23	\$517	\$509	\$638	\$657	\$743	\$786
B2-544-S00 MAP	25"H Juvenile	14" x 16" x 16"	22	\$517	\$509	\$638	\$657	\$743	\$786

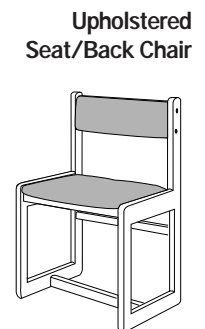

Fabric Requirements: Back 1/4 yards and Seat 1/2 yards per chair, Non-directional, 54" wide.

Please specify Wood Finish (Table 1) and Upholstery; if applicable (Table 5). Details can be found on pages GEN 4 and GEN 5.

Catalog No.	Description	Seat H x W x D	Arm Height	Wt. (lbs.)	COM Price	Wood/G1 Price	Grade 2 Price	Grade 3 Price	Grade 4 Price	Grade 5 Price
All Wood Chair										
<u>All Wood with Arms and Plywood Seat, Oak Wood</u>										
B10ACP18S	32-3/8"H Adult	18" x 18-3/4" x 18"	23	28		\$586				
<u>All Wood with Arms and Plywood Seat, Maple Wood</u>										
B1MACP18S	32-3/8"H Adult	18" x 18-3/4" x 18"	23	28		\$608				
<u>All Wood with Arms and Solid (Saddle) Seat, Oak Wood</u>										
B10ACW18S	32-3/8"H Adult	18" x 18-3/4" x 18"	23	28		\$607				
<u>All Wood with Arms and Solid (Saddle) Seat, Maple Wood</u>										
B1MACW18S	32-3/8"H Adult	18" x 18-3/4" x 18"	23	28		\$631				

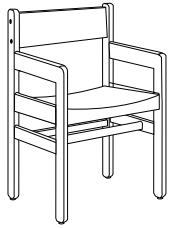

Upholstered Back

<u>Wood Framed with Arms and Upholstered Back/Plywood Seat, Oak Wood</u>										
B10ACPUB18S	32-3/8"H Adult	18" x 18-3/4" x 18"	23	28	\$638	\$637	\$657	\$673	\$825	\$860
<u>Wood Framed with Arms and Upholstered Back/Plywood Seat, Maple Wood</u>										
B1MACPUB18S	32-3/8"H Adult	18" x 18-3/4" x 18"	23	28	\$662	\$661	\$683	\$699	\$862	\$899
<u>Wood Framed with Arms and Upholstered Back/Solid (Saddle) Seat, Oak Wood</u>										
B10ACWUB18S	32-3/8"H Adult	18" x 18-3/4" x 18"	23	28	\$654	\$653	\$676	\$693	\$851	\$887
<u>Wood Framed with Arms and Upholstered Back/Solid (Saddle) Seat, Maple Wood</u>										
B1MACWUB18S	32-3/8"H Adult	18" x 18-3/4" x 18"	23	28	\$680	\$679	\$703	\$721	\$889	\$928

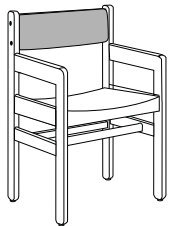

Upholstered Seat

<u>Wood Framed with Arms and Upholstered Seat, Oak Wood</u>										
B10ACUS18S	32-3/8"H Adult	18" x 18-3/4" x 18"	23	28	\$650	\$646	\$699	\$717	\$838	\$874
<u>Wood Framed with Arms and Upholstered Seat, Maple Wood</u>										
B1MACUS18S	32-3/8"H Adult	18" x 18-3/4" x 18"	23	28	\$676	\$671	\$728	\$748	\$875	\$913

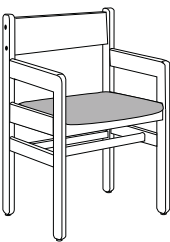

Upholstered Seat and Back

<u>Wood Framed with Arms and Upholstered Seat and Back, Oak Wood</u>										
B10ACUSB18S	32-3/8"H Adult	18" x 18-3/4" x 18"	23	28	\$713	\$704	\$825	\$843	\$925	\$966
<u>Wood Framed with Arms and Upholstered Seat and Back, Maple Wood</u>										
B1MACUSB18S	32-3/8"H Adult	18" x 18-3/4" x 18"	23	28	\$742	\$733	\$862	\$881	\$968	\$1,011

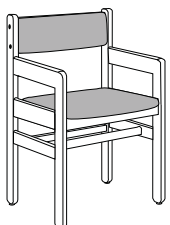

Fabric Requirements: Back 1/4 yards and Seat 1/2 yards per chair, Non-directional, 54" wide.

Please specify Wood Finish (Table 1) and Upholstery; if applicable (Table 5). Details can be found on pages GEN 4 and GEN 5.

B Series Chairs, Sled Base with Arms

Seating

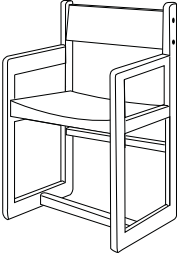
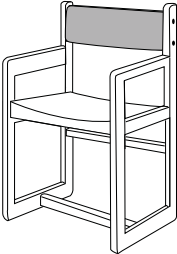
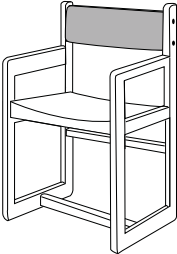
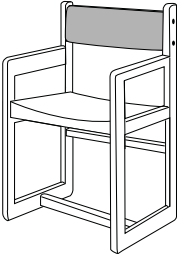
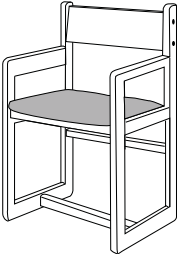
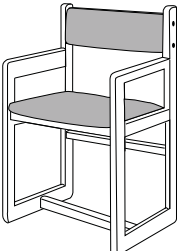
Catalog No.	Description	Seat H x W x D	Arm Height	Wt. (lbs.)	COM Price	Wood/G1 Price	Grade 2 Price	Grade 3 Price	Grade 4 Price	Grade 5 Price	
<u>All Wood with Arms and Plywood Seat , Oak Wood</u>											All Wood Chair 
B2OACP18S	32-3/8"H Adult	18" x 18-3/4" x 18"	23	29		\$586					
<u>All Wood with Arms and Plywood Seat , Maple Wood</u>											
B2MACP18S	32-3/8"H Adult	18" x 18-3/4" x 18"	23	29		\$608					
<u>All Wood with Arms and Solid (Saddle) Seat, Oak Wood</u>											Upholstered Back 
B2OACW18S	32-3/8"H Adult	18" x 18-3/4" x 18"	23	29		\$607					
<u>All Wood with Arms and Solid (Saddle) Seat, Maple Wood</u>											
B2MACW18S	32-3/8"H Adult	18" x 18-3/4" x 18"	23	29		\$631					
<u>Wood Framed with Arms and Upholstered Back/Plywood Seat, Oak Wood</u>											Upholstered Back 
B2OACPUB18S	32-3/8"H Adult	18" x 18-3/4" x 18"	23	29	\$638	\$637	\$657	\$673	\$825	\$860	
<u>Wood Framed with Arms and Upholstered Back/Plywood Seat, Maple Wood</u>											
B2MACPUB18S	32-3/8"H Adult	18" x 18-3/4" x 18"	23	29	\$662	\$661	\$683	\$699	\$862	\$899	
<u>Wood Framed with Arms and Upholstered Back/Solid (Saddle) Seat, Oak Wood</u>											Upholstered Back 
B2OACWUB18S	32-3/8"H Adult	18" x 18-3/4" x 18"	23	29	\$654	\$653	\$676	\$693	\$851	\$887	
<u>Wood Framed with Arms and Upholstered Back/Solid (Saddle) Seat, Maple Wood</u>											
B2MACWUB18S	32-3/8"H Adult	18" x 18-3/4" x 18"	23	29	\$680	\$679	\$703	\$721	\$889	\$928	
<u>Wood Framed with Arms and Upholstered Seat, Oak Wood</u>											Upholstered Seat 
B2OACUS18S	32-3/8"H Adult	18" x 18-3/4" x 18"	23	29	\$650	\$646	\$699	\$717	\$838	\$874	
<u>Wood Framed with Arms and Upholstered Seat, Maple Wood</u>											
B2MACUS18S	32-3/8"H Adult	18" x 18-3/4" x 18"	23	29	\$676	\$671	\$728	\$748	\$875	\$913	
<u>Wood Framed with Arms and Upholstered Seat and Back, Oak Wood</u>											Upholstered Seat and Back 
B2OACUSB18S	32-3/8"H Adult	18" x 18-3/4" x 18"	23	29	\$713	\$704	\$825	\$843	\$925	\$966	
<u>Wood Framed with Arms and Upholstered Seat and Back, Maple Wood</u>											
B2MACUSB18S	32-3/8"H Adult	18" x 18-3/4" x 18"	23	29	\$742	\$733	\$862	\$881	\$968	\$1,011	

Fabric Requirements: Back 1/4 yards and Seat 1/2 yards per chair, Non-directional, 54" wide.

Please specify Wood Finish (Table 1) and Upholstery; if applicable (Table 5). Details can be found on pages GEN 4 and GEN 5.

Catalog No.	Description	Seat H x W x D	Wt. (lbs.)	COM Price	Wood/G1 Price	Grade 2 Price	Grade 3 Price	Grade 4 Price	Grade 5 Price	
Leg Base Stool										
<i>Leg Base Stool with Upholstered Seat, Oak Wood</i>										
B1-555-S00 OAK	Adult Height	18" x 18-3/4" x 18"	18	\$429	\$424	\$472	\$485	\$620	\$656	
B1-Y55-S00 OAK	Youth Height	16" x 16-1/16" x 16"	18	\$429	\$424	\$472	\$485	\$620	\$656	
B1-J55-S00 OAK	Juvenile Height	14" x 16-1/16" x 16"	18	\$429	\$424	\$472	\$485	\$620	\$656	
<i>Leg Base Stool with Upholstered Seat, Maple Wood</i>										
B1-555-S00 MAP	Adult Height	18" x 18-3/4" x 18"	18	\$455	\$450	\$501	\$514	\$658	\$696	
B1-Y55-S00 MAP	Youth Height	16" x 16-1/16" x 16"	18	\$455	\$450	\$501	\$514	\$658	\$696	
B1-J55-S00 MAP	Juvenile Height	14" x 16-1/16" x 16"	18	\$455	\$450	\$501	\$514	\$658	\$696	
Sled Base Stool										
<i>Sled Base Stool with Upholstered Seat, Oak Wood</i>										
B2-555-S00 OAK	Adult Height	18" x 18-3/4" x 18"	18	\$429	\$424	\$472	\$485	\$620	\$656	
B2-Y55-S00 OAK	Youth Height	16" x 16-1/16" x 16"	18	\$429	\$424	\$472	\$485	\$620	\$656	
B2-J55-S00 OAK	Juvenile Height	14" x 16-1/16" x 16"	18	\$429	\$424	\$472	\$485	\$620	\$656	
<i>Sled Base Stool with Upholstered Seat, Maple Wood</i>										
B2-555-S00 MAP	Adult Height	18" x 18-3/4" x 18"	18	\$455	\$450	\$501	\$514	\$658	\$696	
B2-Y55-S00 MAP	Youth Height	16" x 16-1/16" x 16"	18	\$455	\$450	\$501	\$514	\$658	\$696	
B2-J55-S00 MAP	Juvenile Height	14" x 16-1/16" x 16"	18	\$455	\$450	\$501	\$514	\$658	\$696	
Standing Height Sled Base Stool										
<i>Standing Height Sled Base Stool with Upholstered Seat, Oak Wood</i>										
B2-655-S00 OAK	Standing Height	28" x 16" x 16-5/8"	20	\$494	\$492	\$546	\$560	\$717	\$759	
<i>Standing Height Sled Base Stool with Upholstered Seat, Maple Wood</i>										
B2-655-S00 MAP	Standing Height	28" x 16" x 16-5/8"	20	\$524	\$522	\$574	\$594	\$761	\$805	

Fabric Requirements: Seat 1/2 yards per chair, Non-directional, 54" wide.

Please specify Wood Finish (Table 1) and Upholstery; if applicable (Table 5). Details can be found on pages GEN 4 and GEN 5.

General Specifications

Calyx Chair

FRAME

The chair frame is constructed of 5/8" diameter, 13-gauge steel tubing with reinforcing rods inside the bends. Frames are BIFMA tested. Frames will have a bright chrome surface finish or can be finished with electrostatic applied epoxy powder-coat paint. The legs are equipped with heavy-duty nylon glides.

SHELL

Shells are 9-ply Beech or Birch heat induction pressed plywood. Shell dimensions are 16"W x 17"D x 15"H x 1/2" thick. Available in three surface materials: Polyester, HP Laminate and Veneer.

GLIDES

Each chair leg is equipped with a 5/8" diameter heavy-duty nylon glide that fits inside chair leg.

Note: Calyx chairs are stackable up to 5 high.



Calyx Counter Height Stool

FRAME

The stool frame is constructed of 5/8" diameter, 13-gauge steel tubing with reinforcing rods inside the bends. Frames are BIFMA tested. Frames will have a bright chrome surface finish or can be finished with electrostatic applied epoxy powder-coat paint. The legs are equipped with heavy-duty nylon glides.

SHELL

Shells are 9-ply Beech or Birch heat induction pressed plywood. Shell dimensions are 16"W x 17"D x 15"H x 1/2" thick. Available in three surface materials: Polyester, HP Laminate and Veneer.

GLIDES

Each stool leg is equipped with a 5/8" diameter heavy-duty nylon glide that fits inside stool leg.



Calyx Bar Height Stool

FRAME

The stool frame is constructed of 1/2" diameter steel rod. Frames are BIFMA tested. Frames will have a bright chrome surface finish or can be finished with electrostatic applied epoxy powder-coat paint. The sled base frames are equipped with heavy-duty nylon glides.

SHELL

Shells are 9-ply Beech or Birch heat induction pressed plywood. Shell dimensions are 16"W x 17"D x 15"H x 1/2" thick. Available in three surface materials: Polyester, HP Laminate and Veneer.

GLIDES

Stool frames are equipped with external heavy-duty nylon glides that fit onto the sled base frame.



Catalog No.	Description	Overall Height	Seat H x W x D	Wt. (lbs.)	Price
Polyester Face with Chrome Frame Chair					
<u>Polyester Face and Chrome Frame</u>					
CXPC18S	Adult Height	31"	18" x 16" x 17"	13	\$286
CXPC16S	Youth Height	29"	16" x 16" x 17"	13	\$286

Please specify Polyester Face Color: Red, Black or White.



Veneer Face with Chrome or Powder-Coat Frame Chair

<u>Maple Veneer Face and Chrome Frame</u>					
CXVC18MAPS	Adult Height	31"	18" x 16" x 17"	13	\$452
CXVC16MAPS	Youth Height	29"	16" x 16" x 17"	13	\$452
<u>Oak Veneer Face and Chrome Frame</u>					
CXVC18OAKS	Adult Height	31"	18" x 16" x 17"	13	\$452
CXVC16OAKS	Youth Height	29"	16" x 16" x 17"	13	\$452
<u>Maple Veneer Face and Powder-Coat Frame</u>					
CXVP18MAPS	Adult Height	31"	18" x 16" x 17"	13	\$477
CXVP16MAPS	Youth Height	29"	16" x 16" x 17"	13	\$477
<u>Oak Veneer Face and Powder-Coat Frame</u>					
CXVP18OAKS	Adult Height	31"	18" x 16" x 17"	13	\$477
CXVP16OAKS	Youth Height	29"	16" x 16" x 17"	13	\$477

Please specify Wood Finish (Table 1) and Powder-Coated Metal Frame Color (Table 3). Details can be found on pages GEN 4 and GEN 5.



Catalog No.	Description	Overall Height	Seat H x W x D	Wt. (lbs.)	Price
<i>Brodart Standard Laminate Face and Chrome Frame</i>					
CXLC18S	Adult Height	31"	18" x 16" x 17"	13	\$333
CXLC16S	Youth Height	29"	16" x 16" x 17"	13	\$333
<i>Brodart Standard Laminate Face and Powder-Coat Frame</i>					
CXLP18S	Adult Height	31"	18" x 16" x 17"	13	\$358
CXLP16S	Youth Height	29"	16" x 16" x 17"	13	\$358

Brodart Standard Laminate Face with Chrome or Powder-Coat Frame Chair



Please specify Brodart Standard Laminate (Table 4) and Powder-Coated Metal Frame Color (Table 3). Details can be found on pages GEN 4 and GEN 5.

<i>Customer Specified Laminate Face and Chrome Frame</i>					
CXCC18S	Adult Height	31"	18" x 16" x 17"	13	\$396
CXCC16S	Youth Height	29"	16" x 16" x 17"	13	\$396
<i>Customer Specified Laminate Face and Powder-Coat Frame</i>					
CXCP18S	Adult Height	31"	18" x 16" x 17"	13	\$421
CXCP16S	Youth Height	29"	16" x 16" x 17"	13	\$421

Customer Specified Laminate Face with Chrome or Powder-Coat Frame Chair



Please specify any Grade 1 Wilsonart Laminate with -60 Finish (Table 2) and Powder-Coated Metal Frame Color (Table 3). Details can be found on pages GEN 4 and GEN 5. *Minimum Quantity 15.*

Catalog No.	Description	Overall Height	Seat H x W x D	Wt. (lbs.)	Price
Polyester Face with Chrome Frame Stool					
<u>Polyester Face Chrome Frame</u>					
CXPC30S	Bar Height Stool	43-1/4"	30" x 16" x 17"	17	\$440
CXPC24S	Counter Height Stool	37-1/4"	24" x 16" x 17"	16	\$440

Please specify Polyester Face Color: Red, Black or White.



Bar Height



Counter Height

Veneer Face with Chrome or Powder-Coat Frame Stool					
<u>Maple Veneer Face and Chrome Frame</u>					
CXVC30MAPS	Bar Height Stool	43-1/4"	30" x 16" x 17"	17	\$606
CXVC24MAPS	Counter Height Stool	37-1/4"	24" x 16" x 17"	16	\$606



Bar Height



Counter Height

Oak Veneer Face and Chrome Frame

CXVC30OAKS	Bar Height Stool	43-1/4"	30" x 16" x 17"	17	\$606
CXVC24OAKS	Counter Height Stool	37-1/4"	24" x 16" x 17"	16	\$606

Maple Veneer Face and Powder-Coat Frame

CXVP30MAPS	Bar Height Stool	43-1/4"	30" x 16" x 17"	17	\$631
CXVP24MAPS	Counter Height Stool	37-1/4"	24" x 16" x 17"	16	\$631

Oak Veneer Face and Powder-Coat Frame

CXVP30OAKS	Bar Height Stool	43-1/4"	30" x 16" x 17"	17 3	\$631
CXVP24OAKS	Counter Height Stool	37-1/4"	24" x 16" x 17"	16	\$631

Please specify Wood Finish (Table 1) and Powder-Coated Metal Frame Color (Table 3). Details can be found on pages GEN 4 and GEN 5.

Catalog No.	Description	Overall Height	Seat H x W x D	Wt. (lbs.)	Price
-------------	-------------	----------------	----------------	------------	-------

Brodart Standard Laminate Face and Chrome Frame

CXLC30S	Bar Height Stool	43-1/4"	30" x 16" x 17"	17	\$487
CXLC24S	Counter Height Stool	37-1/4"	24" x 16" x 17"	16	\$487

Brodart Standard Laminate Face with Chrome or Powder-Coat Frame Chair

Brodart Standard Laminate Face and Powder-Coat Frame

CXLP30S	Bar Height Stool	43-1/4"	30" x 16" x 17"	17	\$512
CXLP24S	Counter Height Stool	37-1/4"	24" x 16" x 17"	16	\$512

Please specify Brodart Standard Laminate (Table 4) and Powder-Coated Metal Frame Color (Table 3). Details can be found on pages GEN 4 and GEN 5.

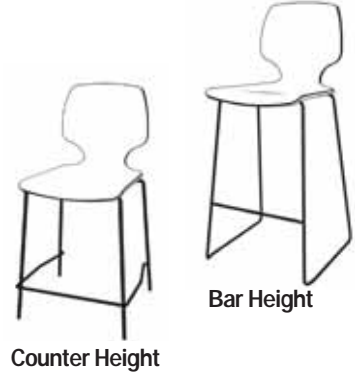

Customer Specified Laminate Face and Chrome Frame

CXCC30S	Bar Height Stool	43-1/4"	30" x 16" x 17"	17	\$550
CXCC24S	Counter Height Stool	37-1/4"	24" x 16" x 17"	16	\$550

Customer Specified Laminate Face with Chrome or Powder-Coat Frame Chair

Customer Specified Laminate Face and Powder-Coat Frame

CXCP30S	Bar Height Stool	43-1/4"	30" x 16" x 17"	17	\$575
CXCP24S	Counter Height Stool	37-1/4"	24" x 16" x 17"	16	\$575

Please specify any Grade 1 Wilsonart Laminate with -60 Finish (Table 2) and Powder-Coated Metal Frame Color (Table 3). Details can be found on pages GEN 4 and GEN 5. *Minimum Quantity 15.*

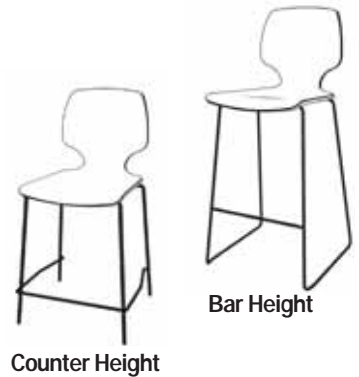

General Specifications

SHELL

Shells are 9-ply Beech or Birch heat induction pressed 1/2" thick plywood. Shell dimensions are 16"W x 17"D x 15"H x 1/2" thick. Available in three surface materials: Polyester, HP Laminate and Veneer. Two options for mechanism – swivel or swivel tilt.

FIVE STAR BASE

Black nylon, five star. Pneumatic height adjustment, 5" range. Casters suitable for carpet or hard surfaces

Catalog No.	Description	Overall Height	Seat H x W x D	Wt. (lbs.)	Price
<i>Polyester Face with Black Five Star Base</i>					
CXPBSWS	Swivel	29-1/2"-34-1/2"	16"-21" x 16" x 17"	18	\$449
CXPBSTS	Swivel Tilt	29-1/2"-34-1/2"	16"-21" x 16" x 17"	18	\$489

Polyester Face with Five Star Base



Please specify Polyester Face Color: Red, Black or White.

<i>Maple Veneer Face with Black Five Star Base</i>					
CXVBSWMAPS	Swivel	29-1/2"-34-1/2"	16"-21" x 16" x 17"	18	\$596
CXVBSTMAPS	Swivel Tilt	29-1/2"-34-1/2"	16"-21" x 16" x 17"	18	\$636
<i>Oak Veneer Face with Black Five Star Base</i>					
CXVBSWOAKS	Swivel	29-1/2"-34-1/2"	16"-21" x 16" x 17"	18	\$596
CXVBSTOAKS	Swivel Tilt	29-1/2"-34-1/2"	16"-21" x 16" x 17"	18	\$636

Veneer Face Swivel Chair with Five Star Base



Please specify Wood Finish (Table 1). Details can be found on page GEN 4.

<i>Brodart Standard Laminate Face with Black Five Star Base</i>					
CXLBSWS	Swivel	29-1/2"-34-1/2"	16"-21" x 16" x 17"	18	\$477
CXLBSTS	Swivel Tilt	29-1/2"-34-1/2"	16"-21" x 16" x 17"	18	\$517

Brodart Laminate Face with Five Star Base



Please specify Brodart Standard Laminate (Table 4). Details can be found on page GEN 4.

<i>Customer Specified Laminate Face with Black Five Star Base</i>					
CXCBSWS	Swivel		16"-21" x 16" x 17"	18	\$527
CXCBSTS	Swivel Tilt		16"-21" x 16" x 17"	18	\$567

Brodart Laminate Face with Five Star Base



Please specify any Grade 1 Wilsonart Laminate with -60 Finish (Table 2). Details can be found on pages GEN 4. *Minimum Quantity 15.*

General Specifications

CHAIR FRAME

Front legs are 1-1/2" square at the top tapering to 1-3/8" square at the bottom. The back legs are 1-1/4" x 1" at the top tapering to 1-3/4" x 1" at the bottom. All vertical and horizontal edges are eased. Lower support stretcher brackets are positioned between the front and back legs and measure 1" x 3/4"; upper stretcher support brackets are located between the front legs and between the back legs and also measure 1 x 3/4". Seat rails are 2-1/4" x 3/4". All joints are mortised, tenoned, and glued.

ALL WOOD CHAIR SEAT

The chair seat is 1" thick solid wood, constructed of glued-up strips not less than 1" or more than 3"W. Seat panels are scooped for seating comfort.

CHAIR BACK

The chair back consists of a horizontal top and bottom rail, and four vertical slats positioned between the rails. The top horizontal rail is 3-1/4" x 3/4" at the center tapering to 2-1/4" x 3/4" at each end. The bottom vertical rail is positioned 1-1/4" above the seat and measures 1-1/2" x 3/4" at the center tapering to 2-1/4" x 3/4". The four vertical slats are positioned 1-5/8" apart and measure 1-1/2" x 3/8". The horizontal rails are mortised, tenoned, and glued into the back leg posts. The vertical slats are mortised, tenoned, and glued into the horizontal rails.

Catalog No.	Description	Seat H x W x D	Wt. (lbs.)	COM Price	Wood/G1 Price	Grade 2 Price	Grade 3 Price	Grade 4 Price	Grade 5 Price
Slat Back Chair									
<i>All Wood, Slat Back Chair without Arms</i>									
CA-571-S00	34"H Adult	18" x 18-3/4" x 15-1/2"	25		\$425				
CA-561-S00	29-1/2"H Youth	16" x 15-1/2" x 14-1/2"	25		\$401				



Please specify Wood Finish (Table 1). Details can be found on page GEN 4.

General Specifications

CHAIR FRAMES

Each frame member is constructed from 1-1/4" hardwood. All frame joints are mortised, tenoned, and glued. Legs, back posts, and stretchers are 1" x 2-3/16"W. Upper side rail is 1" x 3"W; lower side rail is 1" x 2-3/16"W. Front and back top rails are 1" x 2-1/2" shaped to receive seat. The vertical back rails are dog legged for comfort. Tops of front and rear vertical post in side frames have a 3/4" radius, and the bottom of each leg receives a 3/4" radius. Front and back legs are coped with a 7/8" radius on the two outside edges only. The top of the side seat rails, the top of the side stretchers and the top of the cross stretchers are also be coped with a 7/8" radius.

All frames have a 3/4" solid hardwood support brace in each corner of the seat area to give added strength. All seats are fastened with six "Z" brackets routed into the front and back rail and screwed into the bottom of the seat.

CHAIR SEAT

Standard wood seats are 1/2" (adult) or 3/4" (adult extra wide) thick, bent-plywood seat panel faced with select hardwood veneers.

Note: Optional 3/4" thick, hardwood seats, (available at extra charge), are constructed of glued-up strips not less than 1" or more than 3"W. Seat panels are scooped for seating comfort.

Upholstered seats are constructed of 1/2" formed plywood. The plywood is covered with 2" thick foam prior to being covered by a selected upholstery material which is wrapped around and stapled to the underside of seat. The underside of the seat is covered with a black cambric material.

CHAIR BACK

All wood chair backs are 1" x 5" (adult) or 6" (adult extra wide) steam-bent, solid hardwood, screwed into vertical back posts on a 16° angle. The 5" back receives a 1/4" horizontal-design route at the center, creating an appearance of two 2-3/8" slats. The 6" back receives two 1/4" horizontal-design routes positioned to create the appearance of three 1-13/16" slats. Upholstered backs are a full wrap-around, upholstered, 3/4" steam-bent solid-wood panel with an 8"H crown. The back is attached to the chair with four machine screws which pass through the chair back posts.

UPHOLSTERY MATERIALS AND FABRICS

Brodart fabric selections and polyurethane foam are fire rated.



Fabrics which meet Calif. Technical Bulletin #133 are available.

GLIDES

Leg base chairs are equipped with rubber-cushioned glides.

SLED BASE CHAIRS

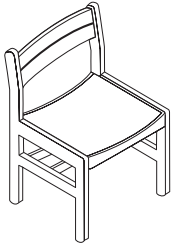
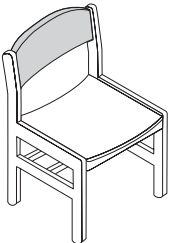
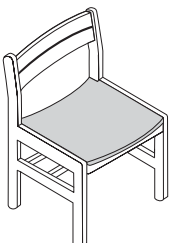

Sled base chairs are of the same construction as leg base chairs but receive two 1" x 2-3/16" rails tenoned and glued to the bottom of leg post to form a sled base. Sled base chairs do not receive glides.

Catalog No.	Description	Seat H x W x D	Wt. (lbs.)	COM Price	Wood/G1 Price	Grade 2 Price	Grade 3 Price	Grade 4 Price	Grade 5 Price	
All Wood Chair										
	<u>All Wood with Slat Back and Plywood Seat, Oak Wood</u>									
D1-551-S00 OAK	32-3/8"H Adult	18" x 18-3/4" x 18"	23		\$470					
<u>All Wood with Slat Back and Plywood Seat, Maple Wood</u>										
D1-551-S00 MAP	32-3/8"H Adult	18" x 18-3/4" x 18"	23		\$484					
<u>All Wood with Slat Back and Solid (Saddle) Seat, Oak Wood</u>										
D1-551-OAK	32-3/8"H Adult	18" x 18-3/4" x 18"	23		\$486					
<u>All Wood with Slat Back and Solid (Saddle) Seat, Maple Wood</u>										
D1-551-OAK MAP	32-3/8"H Adult	18" x 18-3/4" x 18"	23		\$501					
Upholstered Back										
	<u>Wood Framed with Arched Upholstered Back and Plywood Seat, Oak Wood</u>									
D1-553-S00 OAK	32-3/8"H Adult	18" x 18-3/4" x 18"	23	\$513	\$512	\$535	\$557	\$748	\$792	
<u>Wood Framed with Arched Upholstered Back and Plywood Seat, Maple Wood</u>										
D1-553-S00 MAP	32-3/8"H Adult	18" x 18-3/4" x 18"	23	\$529	\$528	\$551	\$574	\$770	\$815	
<u>Wood Framed with Arched Upholstered Back and Solid (Saddle) Seat, Oak Wood</u>										
D1-553-OAK	32-3/8"H Adult	18" x 18-3/4" x 18"	23	\$531	\$529	\$555	\$577	\$771	\$816	
<u>Wood Framed with Arched Upholstered Back and Solid (Saddle) Seat, Maple Wood</u>										
D1-553-OAK MAP	32-3/8"H Adult	18" x 18-3/4" x 18"	23	\$547	\$545	\$571	\$594	\$795	\$840	
Upholstered Seat										
	<u>Wood Framed with Slat Back and Upholstered Seat, Oak Wood</u>									
D1-552-S00 OAK	32-3/8"H Adult	18" x 18-3/4" x 18"	23	\$574	\$570	\$643	\$665	\$832	\$880	
<u>Wood Framed with Slat Back and Upholstered Seat, Maple Wood</u>										
D1-552-S00 MAP	32-3/8"H Adult	18" x 18-3/4" x 18"	23	\$590	\$587	\$662	\$686	\$858	\$907	
Upholstered Seat and Back										
	<u>Wood Framed with Upholstered Seat and Back, Oak Wood</u>									
D1-554-S00 OAK	32-3/8"H Adult	18" x 18-3/4" x 18"	23	\$633	\$626	\$782	\$808	\$914	\$968	
<u>Wood Framed with Upholstered Seat and Back, Maple Wood</u>										
D1-554-S00 MAP	32-3/8"H Adult	18" x 18-3/4" x 18"	23	\$652	\$646	\$805	\$833	\$943	\$997	
<i>Fabric Requirements: Back 1/4 yards and Seat 1/2 yards per chair, Non-directional, 54" wide.</i>										

Please specify Wood Finish (Table 1) and Upholstery; if applicable (Table 5). Details can be found on pages GEN 4 and GEN 5.

D Series Chairs, Sled Base without Arms

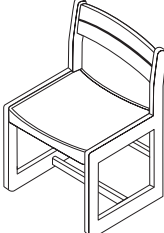
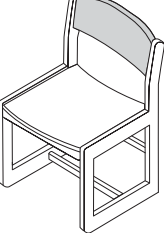
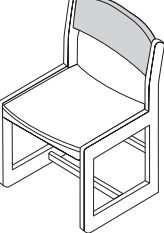
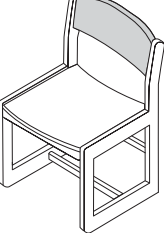
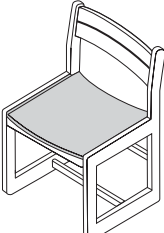
Seating

Catalog No.	Description	Seat H x W x D	Wt. (lbs.)	COM Price	Wood/G1 Price	Grade 2 Price	Grade 3 Price	Grade 4 Price	Grade 5 Price	
<u>All Wood with Slat Back and Plywood Seat, Oak Wood</u>										All Wood Chair 
D2-551-S00 OAK	32"H Adult	18" x 18-3/4" x 18"	23		\$470					
<u>All Wood with Slat Back and Plywood Seat, Maple Wood</u>										
D2-551-S00 MAP	32"H Adult	18" x 18-3/4" x 18"	23		\$484					
<u>All Wood with Slat Back and Solid (Saddle) Seat, Oak Wood</u>										Upholstered Back 
D2-551-OAK	32"H Adult	18" x 18-3/4" x 18"	23		\$486					
<u>All Wood with Slat Back and Solid (Saddle) Seat, Maple Wood</u>										
D2-551-OAK MAP	32"H Adult	18" x 18-3/4" x 18"	23		\$501					
<u>Wood Framed with Arched Upholstered Back and Plywood Seat, Oak Wood</u>										Upholstered Back 
D2-553-S00 OAK	32"H Adult	18" x 18-3/4" x 18"	23	\$513	\$512	\$535	\$557	\$748	\$792	
<u>Wood Framed with Arched Upholstered Back and Plywood Seat, Maple Wood</u>										
D2-553-S00 MAP	32"H Adult	18" x 18-3/4" x 18"	23	\$529	\$528	\$551	\$574	\$770	\$815	
<u>Wood Framed with Arched Upholstered Back and Solid (Saddle) Seat, Oak Wood</u>										Upholstered Back 
D2-553-OAK	32"H Adult	18" x 18-3/4" x 18"	23	\$531	\$529	\$555	\$577	\$771	\$816	
<u>Wood Framed with Arched Upholstered Back and Solid (Saddle) Seat, Maple Wood</u>										
D2-553-OAK MAP	32"H Adult	18" x 18-3/4" x 18"	23	\$547	\$545	\$571	\$594	\$795	\$840	
<u>Wood Framed with Slat Back and Upholstered Seat, Oak Wood</u>										Upholstered Seat 
D2-552-S00 OAK	32"H Adult	18" x 18-3/4" x 18"	23	\$574	\$570	\$643	\$665	\$832	\$880	
<u>Wood Framed with Slat Back and Upholstered Seat, Maple Wood</u>										
D2-552-S00 MAP	32"H Adult	18" x 18-3/4" x 18"	23	\$590	\$587	\$662	\$686	\$858	\$907	
<u>Wood Framed with Upholstered Seat and Back, Oak Wood</u>										Upholstered Seat and Back, Sled Base 
D2-554-S00 OAK	32"H Adult	18" x 18-3/4" x 18"	23	\$633	\$626	\$782	\$808	\$914	\$968	
<u>Wood Framed with Upholstered Seat and Back, Maple Wood</u>										
D2-554-S00 MAP	32"H Adult	18" x 18-3/4" x 18"	23	\$652	\$646	\$805	\$833	\$943	\$997	

Fabric Requirements: Back 1/4 yards and Seat 1/2 yards per chair, Non-directional, 54" wide.

Please specify Wood Finish (Table 1) and Upholstery; if applicable (Table 5). Details can be found on pages GEN 4 and GEN 5.

General Specifications

CHAIR FRAME

The chair frame is constructed of commercial-grade engineered Beech hardwood with components being double-doweled, glued, stapled and screwed. Reinforcing corner blocks are glued and stapled to the front and side rails. The front legs are 1-5/8" x 1"W. The back legs are tapered one piece steam bent 1-1/2" x 3/4" at the top, 2" at the seat rail, and 1-1/4" at base. The front, back and side rails measure 1-3/4" x 1-3/4"W. The chair receives 1" x 3/4"W side stretchers and a center horizontal stretcher. The seat height is 19" from the floor. The overall chair dimension is 34"H x 22"W x 22-1/2"D.

CHAIR SEAT - UPHOLSTERED

The upholstered chair seat is 1/2" thick multi-ply plywood. The seat receives Sytex 100% polyester sheet webbing applied with 1/2" staples at a 45° angle (minimum 3 staples per inch). A 2" thick, HR-55 high-resilient CFC-free, polyurethane foam is glued to the top surface of the seat then upholstered. Cambric material is applied to the bottom of the seat panel.

CHAIR BACK - UPHOLSTERED

The upholstered back is 1/2" thick multi-ply plywood. The back receives a 1/2" thick, HR-55 high-resilient CFC-free, polyurethane foam glued to the top surface of the back panel, then upholstered. The back is inserted in routes in the back crown and seat rail. The back is offered in partial or full upholstered design.

CHAIR BACK - WOOD

The back panel is 1/2" thick multi-ply plywood. The back is offered in exposed wood hourglass design.

CHAIR ARMS

The chair arm is constructed of commercial-grade engineered Beech hardwood. The arm are 1-1/2" x 1"W. The arm is attached to the front leg and frame with metal to metal connection for long term secure fastening.

UPHOLSTERY MATERIALS AND FABRICS

Brodart fabric selections, polyurethane foam and Sytex are CAL 117 fire rated.

CHAIR GLIDES

Each chair leg is equipped with a 7/8" diameter rubber-cushioned glide.

Catalog No.	Overall H x W x D	Seat H x W x D	Wt. (lbs.)	COM Price	Wood/G1 Price	Grade 2 Price	Grade 3 Price	Grade 4 Price	Grade 5 Price
Hourglass Back Chair without Arms <i>Wood Framed, Hourglass Back and Upholstered Seat Chair without Arms</i>									
ENTSC19HBS	34" x 22" x 22-1/2"	19" x 18-3/4" x 18-3/4"	31	\$978	\$929	\$975	\$1,197	\$1,357	\$1,439

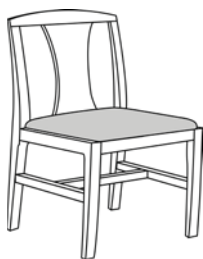

Hourglass Back Chair with Arms <i>Wood Framed, Hourglass Back and Upholstered Seat Chair with Arms (Arm Height 25-3/4")</i>									
ENTAC19HBS	34" x 22" x 22-1/2"	19" x 18-3/4" x 18-3/4"	31	\$1,063	\$1,059	\$1,113	\$1,366	\$1,546	\$1,641



Fabric Requirements: 1-1/4 yards per chair, Non-directional, 54" wide.

Please specify Wood Finish (Table 1) and Upholstery (Table 5). Details can be found on pages GEN 4 and GEN 5.

Catalog No.	Overall H x W x D	Seat H x W x D	Wt. (lbs.)	COM Price	Wood/G1 Price	Grade 2 Price	Grade 3 Price	Grade 4 Price	Grade 5 Price	
<u>Wood Framed, Partially Upholstered Back and Upholstered Seat Chair without Arms</u>										
ENTSC19PBS	34" x 22" x 22-1/2"	19" x 18-3/4" x 18-3/4"	33	\$1,025	\$1,020	\$1,071	\$1,316	\$1,489	\$1,581	Partially Upholstered Back Chair without Arms



<u>Wood Framed, Partially Upholstered Back and Upholstered Seat Chair with Arms (Arm Height 25-3/4")</u>										
ENTAC19PBS	34" x 22" x 22-1/2"	19" x 18-3/4" x 18-3/4"	35	\$1,228	\$1,223	\$1,285	\$1,577	\$1,785	\$1,895	Partially Upholstered Back Chair with Arms



<u>Wood Framed, Fully Upholstered Back and Upholstered Seat Chair without Arms</u>										
ENTSC19FBS	34" x 22" x 22-1/2"	19" x 18-3/4" x 18-3/4"	34	\$1,032	\$1,026	\$1,078	\$1,325	\$1,499	\$1,591	Fully Upholstered Back Chair without Arms

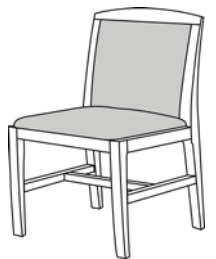

<u>Wood Framed, Fully Upholstered Back and Upholstered Seat Chair with Arms (Arm Height 25-3/4")</u>										
ENTAC19FBS	34" x 22" x 22-1/2"	19" x 18-3/4" x 18-3/4"	37	\$1,234	\$1,229	\$1,292	\$1,586	\$1,796	\$1,906	Fully Upholstered Back Chair with Arms



Fabric Requirements: 2 yards per chair, Non-directional, 54" wide.

Please specify Wood Finish (Table 1) and Upholstery (Table 5). Details can be found on pages GEN 4 and GEN 5.

General Specifications

CHAIR FRAME

Chair frame is 36" overall height and 18-1/2" overall width. Front legs are 1-5/8" square at the top tapering to 1-3/8" square at the bottom. The back post is bent from selected hardwood and finished to a thickness of 1-1/4" and is routed to a proper depth to accept the seat and seat apron to ensure that the vertical sitting load is supported by these horizontal routes. The back top rail is 3-1/2" overall height and 1" thick, and is bent to a radius of 18".

BACK FRAME

The top back rail is double doweled to the vertical back posts and reinforced with #10 x 1-1/4" wood screws. The Essex version with the accent hole gets a 2-1/4" diameter hole positioned on the centerline of top back rail.

On the Essex chair there are five vertical back slats, which are 1-1/2"W x 5/8" thick. The back slats are tenoned the glued into the top rail and bottom rail of the back frame. These slats are equally spaced.

The seat apron is bent from selected hardwood, finished to 7/8" thick by 1-5/8"W and is tenoned and glued to both the front legs and back posts. Side stretchers and cross stretchers are 1"W x 3/4" thick. All joinery is mortised, tenoned, and glued. The cross stretchers at the connecting joint are reinforced with steel pin.

CHAIR SEAT - UPHOLSTERED

The upholstered chair seat panel is 3/4" thick, curved 5-ply plywood. The seat receives 2" thick, HR-55 high-resilient polyurethane foam glued to the top surface of the seat panel, then upholstered. Cambric material is applied to the bottom of the seat panel. The seat rim rests on a horizontal notch in the back post and is attached to the frame by 11 wood screws that are screwed up through the seat apron into the bottom of the seat.

CHAIR SEAT - WOOD

The all-wood seat is 1-1/4" thick, made from random width boards between 1" and 4"W, and scooped for seating comfort. The seat rim rests on a horizontal notch in the back post and is attached to the frame by 11 wood screws that are screwed up through the seat apron into the bottom of the seat.

CHAIR GLIDES

Chairs are equipped with 7/8" diameter nylon glides.

UPHOLSTERY MATERIALS AND FABRICS

Brodart fabric selections and polyurethane foam are fire rated.

Fabrics that meet Calif. Technical Bulletin #133 are available.

Catalog No.	Overall Height	Seat H x W x D	Wt. (lbs.)	COM Price	Wood/G1 Price	Grade 2 Price	Grade 3 Price	Grade 4 Price	Grade 5 Price
-------------	----------------	----------------	------------	-----------	---------------	---------------	---------------	---------------	---------------

All Wood with Vertical Back Slats, Scooped Seat with Solid Top Slat

15-451-S00	36"	18" x 18-1/2" x 17-1/2"	30		\$626				
------------	-----	-------------------------	----	--	-------	--	--	--	--

Scooped Seat Chair with Solid Top Slat



All Wood with Vertical Back Slats, Scooped Seat with Top Slat Cutout

15-471-S00	36"	18" x 18-1/2" x 17-1/2"	30		\$647				
------------	-----	-------------------------	----	--	-------	--	--	--	--

Scooped Seat Chair with Top Slat Cutout



Wood Framed with Vertical Back Slats, Upholstered Seat with Solid Top Slat

15-454-S00	36"	18" x 18-1/2" x 17-1/2"	30	\$656	\$652	\$786	\$813	\$951	\$1,007
------------	-----	-------------------------	----	-------	-------	-------	-------	-------	---------

Upholstered Seat Chair with Solid Top Slat



Wood Framed with Vertical Back Slats, Upholstered Seat with Top Slat Cutout

15-474-S00	36"	18" x 18-1/2" x 17-1/2"	30	\$677	\$673	\$812	\$837	\$982	\$1,040
------------	-----	-------------------------	----	-------	-------	-------	-------	-------	---------

Upholstered Seat Chair with Top Slat Cutout



Fabric Requirements: 1/2 yards per chair, Non-directional, 54" wide.

General Specifications

CHAIR FRAME

Front legs are 1-3/4" square at the top tapering to 1-1/4" square at the bottom and radiused on the front outside frame corner. The back post is 1-1/2" x 1" at the top opening to 2-1/4" x 1" at the widest point, just below the seat platen and tapering to 1-5/8" x 1" at the bottom. All vertical and horizontal edges are eased. The top of the back post receives a radius on the front and outside edges to match the radius of the top back rail.

Two lower support stretchers are positioned between the front and back legs and measure 1" x 3/4"; upper stretcher supports are located between the front legs and between the back legs and also measure 1" x 3/4". Seat rails are 2-1/4" x 3/4". All joints are mortised, tenoned, and glued.

CHAIR SEAT— WOOD

The chair seat is 1" thick solid wood, constructed of glued-up strips not less than 1" or more than 3"W. Seat panels are scooped for seating comfort.

CHAIR SEAT— UPHOLSTERED

The chair seat is 1/2" thick plywood with the front corners receiving a 1-1/2" radius and 1-1/2" thick, 1850 FR Density polyurethane foam. The standard fabric is Brodart's grade one. Brodart's fabric selections and polyurethane foam are fire rated.

Fabrics which meet Calif. Technical Bulletin #133 are available.

CHAIR BACK

The chair back consists of a horizontal top and bottom rail and five vertical slats positioned between the rails. The top horizontal rail is 4" x 3/4". The bottom horizontal rail measures 3-1/2" x 3/4". The five vertical slats are positioned 1-1/4" apart and measure 1-1/8" x 1/2". The horizontal rails are mortised, tenoned, and glued into the back leg posts. The vertical slats are mortised, tenoned, and glued into the horizontal rails.

CHAIR ARMS

Arm is 2-3/8" x 1" at the front tapering to 1-1/4" x 1" at the back. The arm is attached 2" back from the front of the arm to a J-shaped vertical arm support that is 1-1/4" x 1" at the top, expanding to 1-5/8" x 1" at its connection point with the side seat rail. Vertical arm support is attached to the side seat rail with a wood lag bolt & fastened with a washer and nut. The arm is attached to the back post 7-1/2" above the seat platen with a wood screw. Screw head is counter-sunk and capped with a wooden cover.

CHAIR GLIDES

Each chair leg is equipped with a 7/8" diameter rubber cushioned nail glide.

This chair has passed the ANSI/BIFMA X5.1-2002 Type III test.

Catalog No.	Description	Seat H x W x D	Wt. (lbs.)	COM Price	Wood/G1 Price	Grade 2 Price	Grade 3 Price	Grade 4 Price	Grade 5 Price
-------------	-------------	----------------	------------	-----------	---------------	---------------	---------------	---------------	---------------

All Wood, Slat Back without Arms, Oak Wood

ME-551-S00 OAK	34-3/4"H Adult	18 x 18-1/8" x 15-7/8"	20		\$461				
ME-561-S00 OAK	31"H Youth	16 x 17" x 15"	19		\$461				
ME-541-S00 OAK	29"H Juvenile	14 x 17" x 15"	18		\$461				

All Wood, Slat Back without Arms, Maple Wood

ME-551-S00 MAP	34-3/4"H Adult	18 x 18-1/8" x 15-7/8"	20		\$532				
ME-561-S00 MAP	31"H Youth	16 x 17" x 15"	19		\$532				
ME-541-S00 MAP	29"H Juvenile	14 x 17" x 15"	18		\$532				

All Wood Chair without Arms



All Wood, Slat Back with Arms (Arm Height: 26-3/16" Adult, 22-1/2" Youth, 20-1/2" Juvenile), Oak Wood

ME-581-S00 OAK	34-3/4"H Adult	18 x 18-1/8" x 15-7/8"	20		\$557				
ME-591-S00 OAK	31"H Youth	16 x 17" x 15"	19		\$557				
ME-531-S00 OAK	29"H Juvenile	14 x 17" x 15"	18		\$557				

All Wood, Slat Back with Arms (Arm Height: 26-3/16" Adult, 22-1/2" Youth, 20-1/2" Juvenile), Maple Wood

ME-581-S00 MAP	34-3/4"H Adult	18 x 18-1/8" x 15-7/8"	20		\$628				
ME-591-S00 MAP	31"H Youth	16 x 17" x 15"	19		\$628				
ME-531-S00 MAP	29"H Juvenile	14 x 17" x 15"	18		\$628				

All Wood Chair with Arms



Wood Framed, Upholstered Seat and Slat Back without Arms, Oak Wood

ME-552-S00 OAK	34-3/4"H Adult	18 x 18-1/8" x 15-7/8"	20	\$533	\$532	\$659	\$850	\$910	\$974
ME-562-S00 OAK	31"H Youth	16 x 17" x 15"	19	\$533	\$532	\$659	\$850	\$910	\$974
ME-542-S00 OAK	29"H Juvenile	14 x 17" x 15"	18	\$533	\$532	\$659	\$850	\$910	\$974

Wood Framed, Upholstered Seat and Slat Back without Arms, Maple Wood

ME-552-S00 MAP	34-3/4"H Adult	18 x 18-1/8" x 15-7/8"	20	\$608	\$606	\$752	\$969	\$1,038	\$1,110
ME-562-S00 MAP	31"H Youth	16 x 17" x 15"	19	\$608	\$606	\$752	\$969	\$1,038	\$1,110
ME-542-S00 MAP	29"H Juvenile	14 x 17" x 15"	18	\$608	\$606	\$752	\$969	\$1,038	\$1,110

Upholstered Seat Chair without Arms



Wood Framed, Upholstered Seat and Slat Back with Arms (Arm Height: 26-3/16" Adult, 22-1/2" Youth, 20-1/2" Juvenile), Oak Wood

ME-582-S00 OAK	34-3/4"H Adult	18 x 18-1/8" x 15-7/8"	20	\$623	\$621	\$770	\$993	\$1,061	\$1,135
ME-592-S00 OAK	31"H Youth	16 x 17" x 15"	19	\$623	\$621	\$770	\$993	\$1,061	\$1,135
ME-532-S00 OAK	29"H Juvenile	14 x 17" x 15"	18	\$623	\$621	\$770	\$993	\$1,061	\$1,135

Wood Framed, Upholstered Seat and Slat Back with Arms (Arm Height: 26-3/16" Adult, 22-1/2" Youth, 20-1/2" Juvenile), Maple Wood

ME-582-S00 MAP	34-3/4"H Adult	18 x 18-1/8" x 15-7/8"	20	\$693	\$690	\$856	\$1,103	\$1,180	\$1,263
ME-592-S00 MAP	31"H Youth	16 x 17" x 15"	19	\$693	\$690	\$856	\$1,103	\$1,180	\$1,263
ME-532-S00 MAP	29"H Juvenile	14 x 17" x 15"	18	\$693	\$690	\$856	\$1,103	\$1,180	\$1,263

Upholstered Seat Chair with Arms



Fabric Requirements: 1/2 yards per chair, Non-directional, 54" wide.

Please specify Wood Finish (Table 1) and Upholstery; if applicable (Table 5). Details can be found on pages GEN 4 and GEN 5.

General Specifications

CHAIR FRAME

Each frame member is constructed from 1-1/4" hardwoods. All frame joints are mortised, tenoned and glued. All frames have a 3/4" solid hardwood support brace in each corner to give the chair added strength. All seats are fastened with six "Z" brackets routed into the frame and screwed into the bottom of the seat.

CHAIR SEAT

Chair seats are 1/2" thick bent multi-ply faced with select hardwood veneers.

UPHOLSTERED SEAT

Upholstered seats receive 1-1/2" thick HR-55, 2.8 density 55 ILD foam prior to being covered by a selected upholstery material that is wrapped around and stapled to the underside of the seat panel.

WOOD CHAIR BACKS

Chair backs are 5/8" thick bent multi-ply faced with select hardwood veneers. Adult backs are 6-1/2"H x 20-1/4"W. Youth backs are 5-7/8"H x 17-3/8"W.

UPHOLSTERED CHAIR BACKS

Upholstered chair backs have a back platen of curved plywood and receive 1/2" thick 1835 FR, 1.8 density, 35 ILD foam prior to being covered by a selected upholstery material that is wrapped around and stapled to the back of the platen. This upholstered back platen is screwed to the wood back from the rear support.

UPHOLSTERY MATERIALS AND FABRICS

Brodart fabric selections and polyurethane foam are fire rated.

Fabrics that meet Calif. Technical Bulletin #133 are available.

GLIDES

Each chair leg is equipped with a 7/8" diameter rubber-cushioned glide.

Catalog No.	Description	Seat H x W x D	Wt. (lbs.)	COM Price	Wood/G1 Price	Grade 2 Price	Grade 3 Price	Grade 4 Price	Grade 5 Price	
All Ash Wood Chair										
<i>All Ash Wood</i>										
G1-571-S00	31-1/4"H Adult	18" x 20" x 19-5/8"	23		\$476					
G1-561-S00	28-1/4"H Youth	16" x 16" x 17-1/4"	22		\$476					

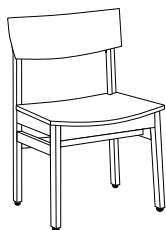

Upholstered Seat/Back Chair

Ash Wood Frame with Upholstered Seat and Back

G1-574-S00	31-1/4"H Adult	18" x 20" x 19-5/8"	23	\$639	\$636	\$788	\$819	\$877	\$939
G1-564-S00	28-1/4"H Youth	16" x 16" x 17-1/4"	22	\$639	\$636	\$788	\$819	\$877	\$939

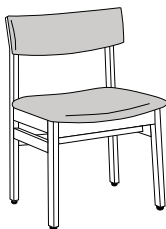

Fabric Requirements: 1 yard per chair, Non-directional, 54" wide.

Please specify Wood Finish (Table 1) and Upholstery, if applicable (Table 5). Details can be found on pages GEN 4 and GEN 5.

General Specifications

CHAIR FRAMES

The chair frame is constructed of straight-grained hardwood. The back posts are cut into a unique curved shape design. The back is curved plywood 3/8" thick.

WOOD CHAIR SEAT

The wood chair seat is hardwood veneer, curved plywood 1/2" thick.



UPHOLSTERED CHAIR SEAT

The upholstered seat uses a 1/2" thick platen with 1-1/2" thick high-resilient polyurethane foam and fabric as selected.

UPHOLSTERY MATERIALS AND FABRICS

Brodart fabric selections and polyurethane foam are fire rated.

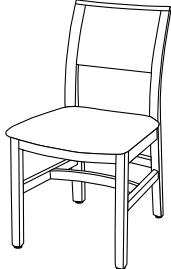
Fabrics which meet Calif. Technical Bulletin #133 are available.

Catalog No	Overall H x D	Seat H x W x D	Wt. (lbs.)	COM Price	Wood/G1 Price	Grade 2 Price	Grade 3 Price	Grade 4 Price	Grade 5 Price	
All Wood										All Wood Chair
NE-571-S00	35" x 22"	18-1/2" x 18-1/2" x 17-3/4"	25		\$521					
Wood Frame with Upholstered Seat										Upholstered Seat Chair
NE-572-S00	35" x 22"	19-1/4" x 18-3/4" x 17-3/4"	25	\$635	\$632	\$758	\$788	\$844	\$904	

Fabric Requirements: 1/2 yard per chair, Non-directional, 54" wide.

Please specify Wood Finish (Table 1) and Upholstery; if applicable (Table 5). Details can be found on pages GEN 4 and GEN 5.

General Specifications

CHAIR FRAME

Chair frame is 36" overall height and 18-1/2" overall width. Front legs are 1-5/8" square at the top tapering to 1-3/8" square at the bottom. The back post is bent from selected hardwood and finished to a thickness of 1-1/4" and is routed to a proper depth to accept the seat and seat apron to ensure that the vertical sitting load is supported by these horizontal routes. The back top rail is 3-1/2" overall height and 1" thick, and is bent to a radius of 18".

The Parallax chair is available with or without an accent hole in the back frame top rail, and with a wood seat or an upholstered seat.

BACK FRAME

The top back rail is double doweled to the vertical back posts and reinforced with #10 x 1-1/4" wood screws. The Parallax version with the accent hole gets a 2-1/4" diameter hole positioned on the centerline of the top back rail.

On the Parallax chair there are five horizontal back slats, which are 1-1/2"W x 5/8" thick. The back slats are tenoned and glued into the side rails of the back frame. These slats are equally spaced.

The seat apron is bent from selected hardwood, finished to 7/8" thick by 1-5/8"W and is tenoned and glued to both the front legs and back posts. Side stretchers and cross stretchers are 1"W x 3/4" thick. All joinery is mortised, tenoned, and glued. The cross stretchers at the connecting joint are reinforced with a steel pin.

CHAIR SEAT (UPHOLSTERED)

The upholstered chair seat panel is 3/4" thick 5-ply plywood. The seat receives a 2" thick, HR-55 high-resilient polyurethane foam glued to the top surface of the seat panel, then upholstered. Cambric material is applied to the bottom of the seat panel. The seat rim rests on a horizontal notch in the back post and is attached to the frame by 11 wood screws that are screwed up through the seat apron into the bottom of the seat.

CHAIR SEAT (WOOD)

The all wood seat is 1-1/4" thick, made from random width boards between 1" and 4"W, and scooped for seating comfort. The seat rim rests on a horizontal notch in the back post and is attached to the frame by 11 wood screws that are screwed up through the seat apron into the bottom of the seat.

GLIDES

Chairs are equipped with 7/8" diameter nylon glides.

UPHOLSTERY MATERIALS AND FABRICS

Brodart fabric selections and polyurethane foam are fire rated.

Fabrics which meet Calif. Technical Bulletin #133 are available.

Parallax Series Chairs, Leg Base without Arms

Seating

Catalog No.	Overall Height	Seat H x W x D	Wt. (lbs.)	COM Price	Wood/G1 Price	Grade 2 Price	Grade 3 Price	Grade 4 Price	Grade 5 Price
-------------	----------------	----------------	------------	-----------	---------------	---------------	---------------	---------------	---------------

All Wood with Horizontal Back Slats, Scooped Seat with Solid Top Slat

Scooped Seat Chair with Solid Top Slat

15-551-S00	36"	18" x 18-1/2" x 17-1/2"	30		\$747				
------------	-----	-------------------------	----	--	-------	--	--	--	--

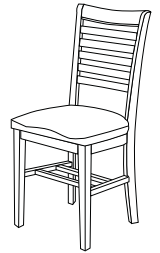

All Wood with Horizontal Back Slats, Scooped Seat with Top Slat Cutout

Scooped Seat Chair with Top Slat Cutout

15-571-S00	36"	18" x 18-1/2" x 17-1/2"	30		\$781				
------------	-----	-------------------------	----	--	-------	--	--	--	--

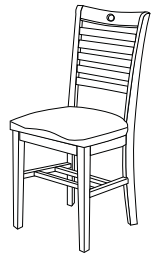

Wood Framed with Horizontal Back Slats, Upholstered Seat with Solid Top Slat

Upholstered Seat Chair with Solid Top Slat

15-554-S00	36"	18" x 18-1/2" x 17-1/2"	30	\$904	\$895	\$1,093	\$1,135	\$1,223	\$1,316
------------	-----	-------------------------	----	-------	-------	---------	---------	---------	---------



Wood Framed with Horizontal Back Slats, Upholstered Seat with Top Slat Cutout

Upholstered Seat Chair with Top Slat Cutout

15-574-S00	36"	18" x 18-1/2" x 17-1/2"	30	\$938	\$929	\$1,133	\$1,177	\$1,266	\$1,362
------------	-----	-------------------------	----	-------	-------	---------	---------	---------	---------

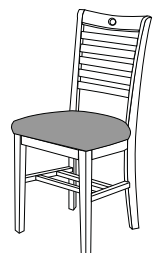

Fabric Requirements: 1/2 yards per chair, Non-directional, 54" wide.

Please specify Wood Finish (Table 1) and Upholstery; if applicable (Table 5). Details can be found on pages GEN 4 and GEN 5.

General Specifications

CHAIR FRAME/LEGS

Chair frames are constructed of 7/8" diameter steel tubing. Cross frames are constructed of 1/2" diameter steel tubing. Front and Rear Cross frames will be bent to follow the seat profile. Frames to be finished with electrostatic applied epoxy powder-coat paint available in a wide range of colors. Legs are equipped with heavy-duty black ABS glide inserts.

CHAIR SEAT

Chair seats are constructed of 1/2" thick molded plywood, faced with Maple, Oak or Walnut veneers. Chair seats measure 16-1/2"W at the front and taper back to 14"W x 18-1/4"D.

CHAIR BACK

Chair backs are constructed of 1/2" thick molded plywood, faced with Maple, Oak or Walnut veneers. Chair backs measure 17-3/4"W x 10-1/4"H.

CHAIR ARMS

Chair arms are constructed of 5/8" thick molded plywood, faced with Maple, Oak or Walnut veneers.



CHAIR GLIDES

Chairs are equipped with 2-3/8"H x 7/8" diameter nylon glides.

NOTES:

Chairs stack four high.

Chairs pass all ANSI / Bifma tests.

	Catalog No.	Seat Height	H x W x D	Wt. (lbs.)	Price
	<i>Powder-Coated Steel Frame without Arms, Plywood Seats and Back Faced with Oak Wood</i>				
	PELN18OAKS	18"	29" x 20" x 23-1/2"	13	\$445
	<i>Powder-Coated Steel Frame without Arms, Plywood Seats and Back Faced with Maple Wood</i>				
	PELN18MAPS	18"	29" x 20" x 23-1/2"	13	\$445
	<i>Powder-Coated Steel Frame without Arms, Plywood Seats and Back Faced Available Only with Clear Finish on Walnut Wood</i>				
	PELN18WALS	18"	29" x 20" x 23-1/2"	13	\$445
	<i>Powder-Coated Steel Frame with Arms, Plywood Seats and Back Faced with Oak Wood</i>				
	PELA18OAKS	18"	29" x 25" x 23-1/2"	17	\$545
	<i>Powder-Coated Steel Frame with Arms, Plywood Seats and Back Faced with Maple Wood</i>				
	PELA18MAPS	18"	29" x 25" x 23-1/2"	17	\$545
	<i>Powder-Coated Steel Frame with Arms, Plywood Seats and Back Faced Available Only with Clear Finish on Walnut Wood</i>				
	PELA18WALS	18"	29" x 25" x 23-1/2"	17	\$545

Please specify Wood Finish (Table 1). Details can be found on page GEN 4.

General Specifications

CHAIR FRAME

Each frame member is constructed from solid hardwood. All frame joints are mortised and tenoned. Horizontal front and back seat rails are 1" thick x 2-1/2"W. The two bottom horizontal cross stretcher rails are 1" thick x 1-1/4"W. On the end frames, the front post is 1" thick x 2-3/16"W, the two back posts are 1" thick x 2-3/8"W, the top side seat rail are 1" thick x 3"W and the two bottom side rails are 2-3/16"W x 1" thick. The end frame is 18-1/8"W at seat level and 24-5/8"W at floor level.

Four corner blocks of solid wood are glued and triple screwed to the end frames and the upper seat horizontal cross members the seats are attached with six metal "Z" brackets.

The bottom of the end frame is shaped so that the chair may sit level or be tilted back at a 10° angle.

CHAIR SEAT – WOOD

Wood seat is 3/4" thick, bent-plywood seat panel faced with select hardwood veneer.

CHAIR SEAT – UPHOLSTERED

Upholstered seat is constructed of formed 1/2" plywood and fitted with 1-1/2" thick foam prior to being covered with the selected upholstery material, which is wrapped around and stapled to the underside of the seat. The underside of the seat is covered with a black cambric material.

CHAIR BACK – WOOD

Chair back is 1" thick x 6"H steam bent solid hardwood in an arched design. Back is attached to vertical back posts at an 8° angle using four 2" joint connector bolts that pass through the vertical back posts.

CHAIR BACK – UPHOLSTERED

Upholstered Chair back is 3/4" steam-bent solid hardwood in an arched design. Back panel is fully wrapped with 1" thick foam prior to being covered by selected upholstery material. Back is attached to vertical back posts at an 8° angle using four 2" joint connector bolts that pass through the vertical back posts.

UPHOLSTERY MATERIALS AND FABRICS

Brodart fabric selections and polyurethane foam are fire rated.

Fabrics which meet Calif. Technical Bulletin #133 are available.

Catalog No.	Overall Height	Seat H x W x D	Wt. (lbs.)	COM Price	Wood/G1 Price	Grade 2 Price	Grade 3 Price	Grade 4 Price	Grade 5 Price
<i>All Wood without Arms, Oak Wood</i>									
2P-571-S00 OAK	32"	18" x 18-3/4" x 17-1/2"	27		\$455				
<i>All Wood without Arms, Maple Wood</i>									
2P-571-S00 MAP	32"	18" x 18-3/4" x 17-1/2"	27		\$455				

All Wood Chair

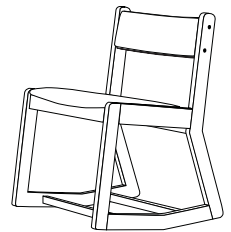

Wood Frame, Upholstered Seat and Back without Arms, Oak Wood

2P-574-S00 OAK	32"	18" x 18-3/4" x 17-1/2"	27	\$593	\$589	\$749	\$783	\$837	\$896
<i>Wood Frame, Upholstered Seat and Back without Arms, Maple Wood</i>									
2P-574-S00 MAP	32"	18" x 18-3/4" x 17-1/2"	27	\$665	\$660	\$839	\$876	\$938	\$1,004

Upholstered Seat/Back Chair

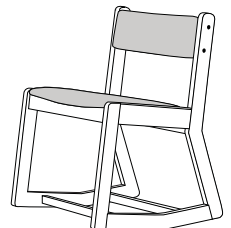

Fabric Requirements: 1/2 yard per chair, Non-directional, 54" wide.

Please specify Wood Finish (Table 1) and Upholstery; if applicable (Table 5). Details can be found on pages GEN 4 and GEN 5.

Lounge Furniture



2017 Price List and Specifications Addendum

Brodart Co. Contract Furniture - Made in USA

280 North Road, Clinton County Industrial Park • McElhattan, PA 17748

Toll-Free: 888-521-1884 • E-Mail: furniture@brodart.com • www.brodartfurniture.com

General Specifications

FRAME

End frame assemblies are constructed of 1" x 3"W solid red oak with outside edges bullnosed. All pieces are mortised, tenoned, and glued to form a solid frame. Leg type or sled type is available.

The front facing of 1" x 3-1/2"W solid oak and the back rail of 1" x 3-1/2" solid oak are mortised, tenoned and glued into the end frame assemblies. Solid hardwood corner blocks are positioned under the cushion frame and screwed to the end frame and the front and back rails.

UPHOLSTERED SEAT/BACK PANEL

The seat and back frame are a single piece of 3/4" bent plywood. The seat portion is fitted with a Dimatrol Webbing and then covered with black cambric fabric for comfort. This is then covered with 3-1/2" thick foam, which is also used on the chair back. The foam is mitered at the jointure of both the seat and back. The entire seat and back assembly is covered with the specified upholstery fabric, except for the underside of the seat which is covered with black cambric fabric.

Brodart upholstery materials meet requirements of the following fire codes: Calif. Technical Bulletin #117 (Sec. E part 1); CS-191-53 class 1.

Fabrics which meet Calif. Technical Bulletin #133 are available.

L1 – Seating has passed the American National Standards Test X5.41983 (ANSI).

GLIDES

Each end frame assembly receive two 1" diameter rubber-cushioned glides.

BENCH – FRAME

End frame assemblies are constructed of 1" x 3"W or 5"W solid oak, with all edges heavily eased. Facing rails are 1" x 3"W solid oak. Bench seats are attached to end frame assemblies by bolting through solid hardwood bolting blocks into internally and externally threaded brass bushings embedded into end frames.

LOUNGE TABLES – FRAME

See L1 Series Bench Frame Construction.

TABLETOP

Tabletop is 3-ply construction consisting of 3/4" thick particleboard core and 3" wood facings, with a .50" thick, high-pressure laminate top sheet and a backing sheet not less than .20" thick for balanced construction. High-pressure laminate has a lo-glare finish resistant to scratches, fading, and staining.

Catalog No.	Seat Height	Arm Height	Overall H x W x D	Wt. (lbs.)	COM Price	Wood/G1 Price	Grade 2 Price	Grade 3 Price	Grade 4 Price	Grade 5 Price
-------------	-------------	------------	-------------------	------------	-----------	---------------	---------------	---------------	---------------	---------------

One Seat Chair, Oak Wood

L1-112-S00 OAK	17"	23"	31" x 26" x 25"	48	\$1,116	\$1,075	\$1,377	\$1,471	\$1,568	\$1,659
----------------	-----	-----	-----------------	----	---------	---------	---------	---------	---------	---------

One Seat Chair, Maple Wood

L1-112-S00 MAP	17"	23"	31" x 26" x 25"	48	\$1,250	\$1,204	\$1,543	\$1,648	\$1,757	\$1,858
----------------	-----	-----	-----------------	----	---------	---------	---------	---------	---------	---------

Fabric Requirements: 2 yards per chair, Non-directional, 54" wide.

Chair, Leg Base



Two Seat Chair, Oak Wood

L1-212-S00 OAK	17"	23"	31" x 50" x 25"	85	\$1,818	\$1,729	\$2,338	\$2,521	\$2,525	\$2,670
----------------	-----	-----	-----------------	----	---------	---------	---------	---------	---------	---------

Two Seat Chair, Maple Wood

L1-212-S00 MAP	17"	23"	31" x 50" x 25"	85	\$2,037	\$1,937	\$2,619	\$2,823	\$2,827	\$2,990
----------------	-----	-----	-----------------	----	---------	---------	---------	---------	---------	---------

Fabric Requirements: 4 yards per chair, Non-directional, 54" wide.

Two Seat, Leg Base



Three Seat Chair, Oak Wood

L1-312-S00 OAK	17"	23"	31" x 74" x 25"	117	\$2,668	\$2,533	\$3,446	\$3,721	\$3,698	\$3,913
----------------	-----	-----	-----------------	-----	---------	---------	---------	---------	---------	---------

Three Seat Chair, Maple Wood

L1-312-S00 MAP	17"	23"	31" x 74" x 25"	117	\$2,988	\$2,836	\$3,860	\$4,168	\$4,142	\$4,382
----------------	-----	-----	-----------------	-----	---------	---------	---------	---------	---------	---------

Fabric Requirements: 6 yards per chair, Non-directional, 54" wide.

Three Seat, Leg Base



Bench, Oak Wood

L1-502-S00 OAK	17"	N/A	18" x 47-1/2" x 20"	51	\$1,102	\$1,073	\$1,158	\$1,184	\$1,565	\$1,656
----------------	-----	-----	---------------------	----	---------	---------	---------	---------	---------	---------

Bench, Maple Wood

L1-502-S00 MAP	17"	N/A	18" x 47-1/2" x 20"	51	\$1,234	\$1,202	\$1,297	\$1,325	\$1,753	\$1,854
----------------	-----	-----	---------------------	----	---------	---------	---------	---------	---------	---------

Fabric Requirements: 2 yards per bench, Non-directional, 54" wide.

Bench, Leg Base

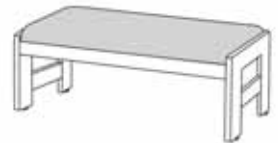

Rectangular Table, Oak Wood

L1-612-S00 OAK	17"	N/A	17" x 47-1/2" x 20"	46		\$1,074				
----------------	-----	-----	---------------------	----	--	---------	--	--	--	--

Rectangular Table, Maple Wood

L1-612-S00 MAP	17"	N/A	17" x 47-1/2" x 20"	46		\$1,201				
----------------	-----	-----	---------------------	----	--	---------	--	--	--	--

Rectangular Table, Leg Base

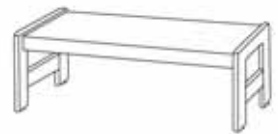

Square Table, Oak Wood

L1-622-S00 OAK	17"	N/A	17" x 29-1/2" x 30"	51		\$1,024				
----------------	-----	-----	---------------------	----	--	---------	--	--	--	--

Square Table, Maple Wood

L1-622-S00 MAP	17"	N/A	17" x 29-1/2" x 30"	51		\$1,148				
----------------	-----	-----	---------------------	----	--	---------	--	--	--	--







Square Table, Leg Base

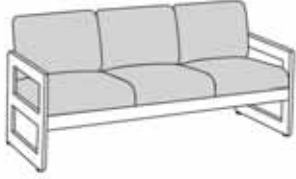

Please specify Wood Finish (Table 1) and Upholstery; if applicable (Table 5). Details can be found on pages GEN 4 and GEN 5.

Lounge Furniture

L1 Lounge Series, Seating & Tables, Sled Base

	Catalog No.	Seat Height	Arm Height	Overall H x W x D	Wt. (lbs.)	COM Price	Wood/G1 Price	Grade 2 Price	Grade 3 Price	Grade 4 Price	Grade 5 Price
Chair, Sled Base 	<u>One Seat Chair, Oak Wood</u>										
	L1-111-S00 OAK	17"	23"	31" x 26" x 25"	48	\$1,116	\$1,075	\$1,377	\$1,471	\$1,568	\$1,659
	<u>One Seat Chair, Maple Wood</u>										
	L1-111-S00 MAP	17"	23"	31" x 26" x 25"	48	\$1,250	\$1,204	\$1,543	\$1,648	\$1,757	\$1,858
<i>Fabric Requirements: 2 yards per chair, Non-directional, 54" wide.</i>											
Two Seat, Sled Base 	<u>Two Seat Chair, Oak Wood</u>										
	L1-211-S00 OAK	17"	23"	31" x 50" x 25"	85	\$1,818	\$1,729	\$2,338	\$2,521	\$2,525	\$2,670
	<u>Two Seat Chair, Maple Wood</u>										
	L1-211-S00 MAP	17"	23"	31" x 50" x 25"	85	\$2,037	\$1,937	\$2,619	\$2,823	\$2,827	\$2,990
<i>Fabric Requirements: 4 yards per chair, Non-directional, 54" wide.</i>											
Three Seat, Sled Base 	<u>Three Seat Chair, Oak Wood</u>										
	L1-311-S00 OAK	17"	23"	31" x 74" x 25"	117	\$2,668	\$2,533	\$3,446	\$3,721	\$3,698	\$3,913
	<u>Three Seat Chair, Maple Wood</u>										
	L1-311-S00 MAP	17"	23"	31" x 74" x 25"	117	\$2,988	\$2,836	\$3,860	\$4,168	\$4,142	\$4,382
<i>Fabric Requirements: 6 yards per chair, Non-directional, 54" wide.</i>											
Bench, Sled Base 	<u>Bench, Oak Wood</u>										
	L1-501-S00 OAK	17"	N/A	18" x 47-1/2" x 20"	51	\$1,102	\$1,073	\$1,158	\$1,184	\$1,565	\$1,656
	<u>Bench, Maple Wood</u>										
	L1-501-S00 MAP	17"	N/A	18" x 47-1/2" x 20"	51	\$1,234	\$1,202	\$1,297	\$1,325	\$1,753	\$1,854
<i>Fabric Requirements: 2 yards per bench, Non-directional, 54" wide.</i>											
Rectangular Table, Sled Base 	<u>Rectangular Table, Oak Wood</u>										
	L1-611-S00 OAK	17"	N/A	17" x 47-1/2" x 20"	46		\$1,074				
	<u>Rectangular Table, Maple Wood</u>										
	L1-611-S00 MAP	17"	N/A	17" x 47-1/2" x 20"	46		\$1,201				
Square Table, Sled Base 	<u>Square Table, Oak Wood</u>										
	L1-621-S00 OAK	17"	N/A	17" x 29-1/2" x 30"	51		\$1,024				
	<u>Square Table, Maple Wood</u>										
	L1-621-S00 MAP	17"	N/A	17" x 29-1/2" x 30"	51		\$1,148				

Please specify Wood Finish (Table 1) and Upholstery; if applicable (Table 5). Details can be found on pages GEN 4 and GEN 5.

General Specifications

BRODART'S CONNECTING MODULAR LOUNGE SYSTEM

Lounge chairs are supplied either with arms on the left side only or the right side only as well as without arms. Individual chairs may be held in position with heavy-duty steel brackets which are provided with each chair.

FRAME

End frame assemblies will be constructed of 1" x 3" wide solid red oak with outside edges bullnosed. All pieces will be mortised, tenoned, and glued to form a solid frame. Leg type and sled type available.

The front facing of 1" x 3-1/2" wide solid oak and the back rail of 1" x 3-1/2" solid oak will be mortised, tenoned and glued into the end frame assemblies. Solid hardwood corner blocks will be positioned under the cushion frame and screwed to the end frame and the front and back rails.

UPHOLSTERED SEAT/BACK PANEL

The seat and back frame are a single piece of 3/4" bent plywood. The seat portion is fitted with a Flex-O-Lator perma mesh system and then covered with black cambric fabric for comfort. This is then covered with 3-1/2" thick foam, which is also used on the chair back. The foam is mitered at the jointure of both the seat and back. The entire seat and back assembly is covered with the specified upholstery fabric, except for the underside of the seat which is covered with black cambric fabric.

Brodart upholstery materials meet requirements of the following fire codes: Calif. Technical Bulletin #117 (Sec. E part 1); CS-191-53 class 1.

Fabrics which meet Calif. Technical Bulletin #133 are available.

GLIDES

Each end frame will receive two adjustable nickel/chrome floor glides.

TABLETOPS

Tabletop will be 1-1/4" thick, particleboard core with solid-wood edges, surfaced with .050 high-pressure laminate and backed with .020 phenolic sheeting. Top is 14" high.



The Top rests on the top edge of the adjoining end frames and is held securely in place with heavy-duty steel brackets, mechanically fastened to the underside of the top.

Lounge Furniture

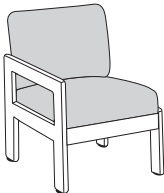
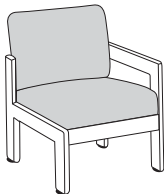
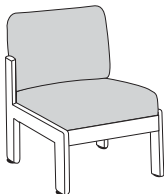
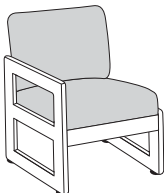
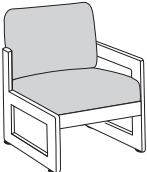
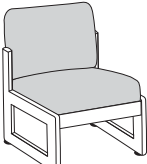
L1 Modular Series, Seating

	Catalog No.	Seat Height	Arm Height	Overall H x W x D	Wt. (lbs.)	COM Price	Wood/G1 Price	Grade 2 Price	Grade 3 Price	Grade 4 Price	Grade 5 Price
Left Arm Chair 	<u>Left Arm Chair with Leg Base, Oak Wood</u>										
	L1-702-S00 OAK	17"	23"	31" x 26" x 25"	40	\$1,725	\$1,797	\$2,264	\$2,423	\$2,623	\$2,773
	<u>Left Arm Chair with Leg Base, Maple Wood</u>										
	L1-702-S00 MAP	17"	23"	31" x 26" x 25"	40	\$1,933	\$2,012	\$2,536	\$2,713	\$2,938	\$3,105
<i>Fabric Requirements: 2 yards per chair, Non-directional, 54" wide.</i>											
Right Arm Chair 	<u>Right Arm Chair with Leg Base, Oak Wood</u>										
	L1-712-S00 OAK	17"	23"	31" x 26" x 25"	40	\$1,725	\$1,797	\$2,264	\$2,423	\$2,623	\$2,773
	<u>Right Arm Chair with Leg Base, Maple Wood</u>										
	L1-712-S00 MAP	17"	23"	31" x 26" x 25"	40	\$1,933	\$2,012	\$2,536	\$2,713	\$2,938	\$3,105
<i>Fabric Requirements: 2 yards per chair, Non-directional, 54" wide.</i>											
Center (Armless) Chair 	<u>Center Armless Chair with Leg Base, Oak Wood</u>										
	L1-722-S00 OAK	17"	N/A	31" x 26" x 25"	35	\$1,676	\$1,745	\$2,201	\$2,353	\$2,549	\$2,694
	<u>Center Armless Chair with Leg Base, Maple Wood</u>										
	L1-722-S00 MAP	17"	N/A	31" x 26" x 25"	35	\$1,877	\$1,954	\$2,464	\$2,636	\$2,854	\$3,018
<i>Fabric Requirements: 2 yards per chair, Non-directional, 54" wide.</i>											
Left Arm Chair 	<u>Left Arm Chair with Sled Base, Oak Wood</u>										
	L1-701-S00 OAK	17"	23"	31" x 26" x 25"	40	\$1,759	\$1,832	\$2,309	\$2,468	\$2,675	\$2,829
	<u>Left Arm Chair with Sled Base, Maple Wood</u>										
	L1-701-S00 MAP	17"	23"	31" x 26" x 25"	40	\$1,970	\$2,053	\$2,585	\$2,765	\$2,996	\$3,169
<i>Fabric Requirements: 2 yards per chair, Non-directional, 54" wide.</i>											
Right Arm Chair 	<u>Right Arm Chair with Sled Base, Oak Wood</u>										
	L1-711-S00 OAK	17"	23"	31" x 26" x 25"	40	\$1,759	\$1,832	\$2,309	\$2,468	\$2,675	\$2,829
	<u>Right Arm Chair with Sled Base, Maple Wood</u>										
	L1-711-S00 MAP	17"	23"	31" x 26" x 25"	40	\$1,970	\$2,053	\$2,585	\$2,765	\$2,996	\$3,169
<i>Fabric Requirements: 2 yards per chair, Non-directional, 54" wide.</i>											
Center (Armless) Chair 	<u>Center Armless Chair with Sled Base, Oak Wood</u>										
	L1-721-S00 OAK	17"	N/A	31" x 26" x 25"	35	\$1,714	\$1,786	\$2,250	\$2,410	\$2,608	\$2,759
	<u>Center Armless Chair with Sled Base, Maple Wood</u>										
	L1-721-S00 MAP	17"	N/A	31" x 26" x 25"	35	\$1,920	\$2,001	\$2,520	\$2,698	2,921	\$3,090
<i>Fabric Requirements: 2 yards per chair, Non-directional, 54" wide.</i>											

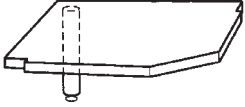
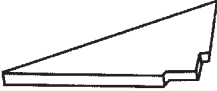
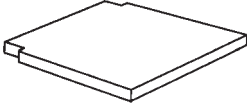
Please specify Wood Finish (Table 1) and Upholstery; if applicable (Table 5). Details can be found on pages GEN 4 and GEN 5.

Oak Catalog No.	Maple Catalog No.	Description	Wt. (lbs.)	Oak Price	Maple Price	
L1-705-S00 OAK	L1-705-S00 MAP	90° Inside Corner Tabletop This top also receives a matching wood leg in the back corner which is also mechanically fastened to the tabletop.	32	\$656	\$714	90° Inside Corner Tabletop 
L1-706-S00 OAK	L1-706-S00 MAP	90° Outside Corner Tabletop	26	\$653	\$711	90° Outside Corner Tabletop 
L1-707-S00 OAK	L1-707-S00 MAP	Straight Tabletop	23	\$815	\$889	Straight Tabletop 
L1-708-S00 OAK	L1-708-S00 MAP	45° Inside Corner Tabletop	26	\$923	\$1,012	45° Inside Corner Tabletop 

Please specify Wood Finish (Table 1) . Details can be found on page GEN 4.

General Specifications

END FRAME ASSEMBLY

End frames are 24-1/4"H x 26-5/8"D x 2-1/2" thick skeletal type construction. The arm is 24-1/4" high at the front and arches down with a 71" radius to 20-3/4" high at the rear of the arm. The arm assembly receives a 1/4" polyurethane 1240 FR density foam wrap and is fully upholstered. When specified only, the end frame assembly will receive a 1" thick solid wood top cap of either red oak or maple as specified. The wood cap is 3-3/8" wide. The arm assembly on the bottom surface will receive two-nickel chrome plated nail glides.

UPHOLSTERED SEAT AND BACK

The seat and back frame are a single piece of 3/4" bent-plywood. The seat portion is fitted with a Dimatrol Webbing and then covered with black cambric fabric for comfort. This is then covered with 3-1/2" thick foam, which is also used on the chair back. The entire seat and back assembly are covered with the specified upholstery fabric except for the underside of the seat which is covered with a black cambric fabric.

Brodart upholstery materials meet requirements of the following fire codes: Calif. Technical Bulletin #117 (sec. E part 1); CS-191-53 class 1.

Fabrics which meet Calif. Technical Bulletin #133 are available.

Seat height at front – 17"

Arm height – 24-9/32."

SEAT TO ARM STRETCHER RAIL

The front rail is 24-3/4" long x 3-1/2" wide and wrapped with the same 1/4" foam as the ends and upholstery. The seat support rail is 24-3/4" long x 3-1/2" wide and is not upholstered. The rear rail is 24-3/4" long x 11-7/8" wide and is wrapped with the same 1/4" foam as the ends, and is upholstered. All rails are bolted with 1/4"- 20 bolts through metal brackets into metal bushings inserted in the arm assemblies.

Catalog No.	Overall H x W x D	Wt. (lbs.)	COM Price	Wood/G1 Price	Grade 2 Price	Grade 3 Price	Grade 4 Price	Grade 5 Price	
<u>Fully Upholstered Lounge Chair</u>									Fully Upholstered Chair
L4-121-S00	31-3/8" x 30-5/8" x 28-7/16"	55	\$2,425	\$2,354	\$2,631	\$2,935	\$3,438	\$3,636	

Fabric Requirements: 6-1/2 yards per chair, Non-directional, 54" wide.



<u>Upholstered Lounge Chair with Curved Oak Arm Caps</u>									Upholstered w/Arm Caps
L4-122-S00	31-3/8" x 30-5/8" x 28-7/16"	55	\$2,669	\$2,593	\$2,897	\$3,245	\$3,786	\$4,004	
<u>Upholstered Lounge Chair with Curved Maple Arm Caps</u>									
L4-122-S02	31-3/8" x 30-5/8" x 28-7/16"	55	\$2,716	\$2,641	\$2,949	\$3,291	\$3,855	\$4,077	

Fabric Requirements: 6-1/2 yards per chair, Non-directional, 54" wide.



Please specify Wood Finish (Table 1) and Upholstery; if applicable (Table 5). Details can be found on pages GEN 4 and GEN 5.

General Specifications

END FRAME ASSEMBLY

End frames are constructed of legs that are 1" thick x 3"W, a bottom stretcher rail 1" thick x 2-1/4"W and a top arm rail 2-1/2"W x 1" thick that is arched to match the radius of the arm. All parts are constructed from solid red oak. All joints are mortised, tenoned, and glued to form a solid unit.

The arm is 1" thick x 3-3/8"W at the front and tapers to a width of 2-5/8" at the back. The arm is constructed of solid red oak which has been steam bent to a 72" radius.

The front stretcher and front seat rail are 3"W x 1" thick solid red oak. The back seat rail is 2-3/4"W by 1" thick solid red oak. The cross stretcher and seat rails are mortised, tenoned, and glued into the side frames.

UPHOLSTERED SEAT AND BACK

The seat and back frame are a single piece of 3/4" bent-plywood. The seat portion is fitted with a Dimatrol Webbing and then covered with black cambric fabric for comfort. This is then covered with 3-1/2" thick foam, which is also used on the chair back. The entire seat and back assembly are covered with the specified upholstery fabric except for the underside of the seat which is covered with a black cambric fabric.

Brodart upholstery materials meet requirements of the following fire codes: Calif. Technical Bulletin #117 (sec. E part 1); CS-191-53 class 1.

Fabrics which meet Calif. Technical Bulletin #133 are available.

Seat height at front – 16-3/4."

Arm height – 24-9/32."

WOOD PLATEN FOR SIDE FRAME (OPTIONAL)

A 1/4" thick wood platen can be inserted into the side frame at the time of manufacture. This frame is constructed of 1/4" veneered plywood and is mortised into the adjoining frame members.

UPHOLSTERED SIDE FRAME (OPTIONAL)

The side frame is upholstered using 1/4" fire-resistant polyurethane foam over a 1/4" platen and covered with the selected upholstery material.

Catalog No.	Overall H x W x D	Wt. (lbs.)	COM Price	Wood/G1 Price	Grade 2 Price	Grade 3 Price	Grade 4 Price	Grade 5 Price	
<u>One Seat Lounge Chair with Open Frame, Oak Wood</u>									
L5-102-S00 OAK	31-3/8" x 31" x 28-3/8"	45	\$1,766	\$1,746	\$2,065	\$2,164	\$2,551	\$2,696	One Seat with Open Frame
<u>One Seat Lounge Chair with Open Frame, Maple Wood</u>									
L5-102-S00 MAP	31-3/8" x 31" x 28-3/8"	45	\$1,978	\$1,955	\$2,313	\$2,424	\$2,857	\$3,020	
<i>Fabric Requirements: 2 yards per chair, Non-directional, 54" wide.</i>									
<u>One Seat Lounge Chair with Wood Insert, Oak Wood</u>									
L5-103-S00 OAK	31-3/8" x 31" x 28-3/8"	47	\$2,037	\$1,977	\$2,296	\$2,393	\$2,887	\$3,054	One Seat with Wood Insert
<u>One Seat Lounge Chair with Wood Insert, Maple Wood</u>									
L5-103-S00 MAP	31-3/8" x 31" x 28-3/8"	47	\$2,281	\$2,214	\$2,571	\$2,680	\$3,233	\$3,420	
<i>Fabric Requirements: 3 yards per chair, Non-directional, 54" wide.</i>									
<u>One Seat Lounge Chair with Upholstered Insert, Oak Wood</u>									
L5-104-S00 OAK	31-3/8" x 31" x 28-3/8"	47	\$2,172	\$2,085	\$2,420	\$2,521	\$3,045	\$3,221	One Seat with Upholstered Insert
<u>One Seat Lounge Chair with Upholstered Insert, Maple Wood</u>									
L5-104-S00 MAP	31-3/8" x 31" x 28-3/8"	47	\$2,433	\$2,335	\$2,710	\$2,823	\$3,410	\$3,608	
<i>Fabric Requirements: 4 yards per chair, Non-directional, 54" wide.</i>									

Please specify Wood Finish (Table 1) and Upholstery; if applicable (Table 5). Details can be found on pages GEN 4 and GEN 5.

Lounge Furniture

L5 Lounge Series, Seating

	Catalog No.	Overall H x W x D	Wt. (lbs.)	COM Price	Wood/G1 Price	Grade 2 Price	Grade 3 Price	Grade 4 Price	Grade 5 Price	
Two Seat with Open Frame 	<u>Two Seat Lounge Chair with Open Frame, Oak Wood</u>									
	L5-212-S00 OAK	31-3/8" x 55-1/4" x 28-3/8"	80	\$2,773	\$2,648	\$3,288	\$3,478	\$3,867	\$4,089	
	<u>Two Seat Lounge Chair with Open Frame, Maple Wood</u>									
	L5-212-S00 MAP	31-3/8" x 55-1/4" x 28-3/8"	80	\$3,105	\$2,965	\$3,683	\$3,896	\$4,331	\$4,580	
<i>Fabric Requirements: 4 yards per chair, Non-directional, 54" wide.</i>										
Two Seat with Wood Insert 	<u>Two Seat Lounge Chair with Wood Insert, Oak Wood</u>									
	L5-213-S00 OAK	31-3/8" x 55-1/4" x 28-3/8"	82	\$3,255	\$3,078	\$3,716	\$3,908	\$4,493	\$2,708	
	<u>Two Seat Lounge Chair with Wood Insert, Maple Wood</u>									
	L5-213-S00 MAP	31-3/8" x 55-1/4" x 28-3/8"	82	\$3,646	\$3,446	\$4,163	\$4,377	\$5,032	\$3,034	
<i>Fabric Requirements: 5 yards per chair, Non-directional, 54" wide.</i>										
Two Seat with Upholstered Insert 	<u>Two Seat Lounge Chair with Upholstered Insert, Oak Wood</u>									
	L5-214-S00 OAK	31-3/8" x 55-1/4" x 28-3/8"	82	\$3,464	\$3,272	\$3,926	\$4,127	\$4,776	\$5,052	
	<u>Two Seat Lounge Chair with Upholstered Insert, Maple Wood</u>									
	L5-214-S00 MAP	31-3/8" x 55-1/4" x 28-3/8"	82	\$3,880	\$3,665	\$4,397	\$4,622	\$5,349	\$5,658	
<i>Fabric Requirements: 6 yards per chair, Non-directional, 54" wide.</i>										
Three Seat with Open Frame 	<u>Three Seat Lounge Chair with Open Frame, Oak Wood</u>									
	L5-312-S00 OAK	31-3/8" x 79-5/8" x 28-3/8"	115	\$3,685	\$3,497	\$4,454	\$4,742	\$5,105	\$5,398	
	<u>Three Seat Lounge Chair with Open Frame, Maple Wood</u>									
	L5-312-S00 MAP	31-3/8" x 79-5/8" x 28-3/8"	115	\$4,127	\$3,917	\$4,989	\$5,312	\$5,718	\$6,046	
<i>Fabric Requirements: 6 yards per chair, Non-directional, 54" wide.</i>										
Three Seat with Wood Insert 	<u>Three Seat Lounge Chair with Wood Insert, Oak Wood</u>									
	L5-313-S00 OAK	31-3/8" x 79-5/8" x 28-3/8"	117	\$4,160	\$3,893	\$4,851	\$5,139	\$5,684	\$6,010	
	<u>Three Seat Lounge Chair with Wood Insert, Maple Wood</u>									
	L5-313-S00 MAP	31-3/8" x 79-5/8" x 28-3/8"	117	\$4,658	\$4,360	\$5,434	\$5,756	\$6,365	\$6,731	
<i>Fabric Requirements: 7 yards per chair, Non-directional, 54" wide.</i>										
Three Seat with Upholstered Insert 	<u>Three Seat Lounge Chair with Upholstered Insert, Oak Wood</u>									
	L5-314-S00 OAK	31-3/8" x 79-5/8" x 28-3/8"	117	\$4,357	\$4,074	\$5,046	\$5,332	\$5,948	\$6,290	
	<u>Three Seat Lounge Chair with Upholstered Insert, Maple Wood</u>									
	L5-314-S00 MAP	31-3/8" x 79-5/8" x 28-3/8"	117	\$4,880	\$4,563	\$5,651	\$5,972	\$6,663	\$7,045	
<i>Fabric Requirements: 8 yards per chair, Non-directional, 54" wide.</i>										

Please specify Wood Finish (Table 1) and Upholstery; if applicable (Table 5). Details can be found on pages GEN 4 and GEN 5.

General Specifications

TABLETOPS



Tabletops are 1-3/16" thick, 3-ply, 45# density particleboard core with a .050" thick, high-pressure laminate top sheet and a backing sheet not less than .020" thick for balanced construction. High-pressure laminate has a lo-glare finish resistant to scratches, fading, and staining. Edges are solid Northern-grown red oak. The edge band is applied before the top laminate sheet constituting an internal edge band.

APRON

A 3-1/2"W x 1" thick solid Northern-grown red oak apron is fitted between the legs, and behind the extended tabletop edge band. Bottom edge and both ends of each apron receive a 1/2" radius. Aprons are secured to the tabletop by attaching hardwood cleats to the inside surface of the aprons and screwing through the cleats into the underside of the tabletop.

LEGS

Legs are glued up, 2-1/4" solid Northern-grown red oak. All vertical edges of legs receive a 1/2" radius. Bottom edges of legs are radiused 1/8". Each leg has a 2" diameter, adjustable glide mounted in a recessed tee-nut. The glide is further recessed into the leg by means of counter-sunk boring which accepts the upper two-thirds of the glide. Legs attach to the aprons by means of formed 14-gauge steel corner brackets. Each leg is bolted to the corner bracket with two 5/16"-hex-head bolts per leg.

Oak Catalog No.	Maple Catalog No.	Description	H x W x D	Wt. (lbs.)	Oak Price	Maple Price	
LX-626-S00 OAK	LX-626-S00 MAP	Round Table	16-3/16" x 36" Diameter	66	\$1,467	\$1,643	Round
							
LX-625-S00 OAK	LX-625-S00 MAP	Square Table	16-3/16" x 30" x 30"	51	\$1,220	\$1,366	Square
							
LX-627-S00 OAK	LX-627-S00 MAP	Rectangular Table	16-3/8" x 48" x 24"	46	\$1,291	\$1,444	Rectangular
							

Please specify Wood Finish (Table 1) and High-Pressure Laminate (Table 2). Details can be found on page GEN 4.

Lounge Furniture

LX Lounge Series, Cylinder & Cube Tables

	Oak Catalog No.	Maple Catalog No.	Description	H x W x D	Wt. (lbs.)	Oak Price	Maple Price
Cylinder Tables 	LX-620-S00 OAK	LX-620-S00 MAP	Cylinder Table	18" x 18" Diameter	20	\$1,121	\$1,256
	LX-621-S00 OAK	LX-621-S00 MAP	Cylinder Table	18" x 24" Diameter	31	\$1,385	\$1,552
	LX-622-S00 OAK	LX-622-S00 MAP	Cylinder Table	18" x 30" Diameter	42	\$1,581	\$1,771

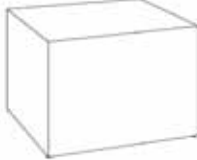
Cube Tables 	LX-610-S00 OAK	LX-610-S00 MAP	Cube Table	18" x 18" x 18"	50	\$1,442	\$1,615
	LX-611-S00 OAK	LX-611-S00 MAP	Cube Table	18" x 24" x 24"	73	\$1,611	\$1,804
	LX-612-S00 OAK	LX-612-S00 MAP	Cube Table	18" x 30" x 30"	100	\$1,857	\$2,079

Note: Cylinder and Cube Table are All Wood Veneer with no laminate.

Please specify Wood Finish (Table 1). Details can be found on page GEN 4.

General Specifications

FRAME

Frame members are constructed from premium hardwood plywood and rails, posts, and other main frame parts are of lumber not less than 5/4" thick kiln dried to a moisture content of 6-8%. All lumber is of sound stock, without knots, shakes or other defects which affect appearance and/or performance. All main frame joints are puzzle-joint construction with overlapped and notched hardwood plywood components. In addition, the frame is glued, stapled, and wood screws are used where necessary for further structural integrity.

UPHOLSTERY CONSTRUCTION

The seat platform is constructed with sinuous 7.5-gauge steel wire springs firmly attached to the front and back rails. Springs are installed on 5" c/c. A spring unit surface is attained by attaching two (2) 16 gauge insulated steel tie wires (#F16SW) to each spring with Hartco clips running the entire length of the seat. A Flex-O-Lator unit is laid over the springs. The surface is covered with a layer of woven polypropylene matting and five (5) inches of Ultracel premium polyurethane foam.

The back receives Universal sinuous 7.5-gauge steel wire springs firmly attached to the top and bottom rails. Springs are installed on 5" c/c. A spring unit surface is attained by attaching two (2) 16-gauge insulated steel tie wires (#F16SW) to each spring with Hartco clips running the entire length of the back. A 2-1/2" layer of premium ultracel polyurethane foam with a compression of 20 pounds is covered with a layer of polyester fiber. The surface is covered with a layer of woven polypropylene matting and 2-1/2" Ultracel premium polyurethane foam.

Arm sides are covered with furniture grade paperboard. The tops of the arms receive a contoured H.D. bonded foam insert for softness and a final layer of 1/2" foam is applied over the top and sides of the arms.

TABLET ARM

Standard tablet arm is bow front laminate top with black T-mold. WilsonArt laminates available for the laminate surface. Tablet is mounted to the right arm in the seated position. Standard bow front design is 22"W x 13"D. Tablet arm available in optional left arm seated position.

Note: WilsonArt Black 1595-60 laminate is the standard on tablet arm. Please designate the WilsonArt laminate to be provided.

CASTERS (OPTIONAL)

Front casters are locking hard wheel with a load rating of 110 lbs. Mounting height is 2-1/2", wheel diameter is 55mm and cup diameter is 45mm.

FINAL ASSEMBLY

The underside bottom of the chair is covered with a sheet of cambric for dust protection. The base frame of the chair receives four extruded plastic legs. Legs measure 2-1/2"H and are 2" diameter. Chairs are packed using padding and shrink wrap to minimize movement during shipping.

WOOD FINISH

Exposed wood is of Beech construction and machine sanded and stained. Wood is then sealed and finished with a conversion varnish topcoat.

C.O.M. FABRIC

For C.O.M. fabric on multiple rolls, add an additional yard of fabric per roll to the yardage requirements. Multiple rolls have shorter pieces of fabric and do not allow nesting or stacking to achieve the best yield which may result in yardage shortages. Request for additional fabric from the client may delay the order. Yardage should be added to the roll and not provided separately.

Brodart upholstery materials meet requirements of the following fire codes: Calif. Technical Bulletin #117 (Sec. E part 1); CS-191-53 class 1.

Fabrics which meet Calif. Technical Bulletin #133 are available.

Lounge Furniture

Engage Lounge Series, Seating

Catalog No.	Overall H x W x D	Wt. (lbs.)	COM Price	Wood/G1 Price	Grade 2 Price	Grade 3 Price	Grade 4 Price	Grade 5 Price
Lounge Chair								
<u>Upholstered Lounge Chair, No Wood Arm Caps, No Casters</u>								
ENGLNG1SS	32-1/2" x 31-1/2" x 30"	65	\$2,756	\$2,676	\$2,890	\$3,317	\$3,907	\$4,120
<u>Upholstered Lounge Chair with Wood Arm Caps, No Casters</u>								
ENGLNG1SWAS	32-1/2" x 31-1/2" x 30"	65	\$3,122	\$3,031	\$3,273	\$3,758	\$4,425	\$4,668
<u>Upholstered Lounge Chair with Casters, No Wood Arm Caps</u>								
ENGLNG1SFCS	32-1/2" x 31-1/2" x 30"	65	\$2,937	\$2,851	\$3,078	\$3,536	\$4,162	\$4,391
<u>Upholstered Lounge Chair with Wood Arm Caps and Casters</u>								
ENGLNG1SWAFCS	32-1/2" x 31-1/2" x 30"	65	\$3,303	\$3,206	\$3,463	\$3,976	\$4,681	\$4,938

Note: All Lounge Chairs have a 18-1/2" Seat Height and a 24-1/2" Arm Height.

Fabric Requirements: 4-1/2 yards per chair, Non-directional, 54" wide.

Lounge Chair with Tablet Arm								
<u>Upholstered Lounge Chair with Tablet, No Wood Arm Caps, No Casters</u>								
ENGLNG1SRTS	32-1/2" x 31-1/2" x 30"	75	\$3,128	\$3,037	\$3,280	\$3,766	\$4,434	\$4,677
<u>Upholstered Lounge Chair with Tablet, Wood Arm Caps, No Casters</u>								
ENGLNG1SRTWAS	32-1/2" x 31-1/2" x 30"	75	\$3,494	\$3,393	\$3,664	\$4,205	\$4,952	\$5,223
<u>Upholstered Lounge Chair with Tablet, Casters, No Wood Arm Caps</u>								
ENGLNG1SRTFCS	32-1/2" x 31-1/2" x 30"	75	\$3,309	\$3,212	\$3,469	\$3,983	\$4,690	\$4,947
<u>Upholstered Lounge Chair with Tablet, Wood Arm Caps and Casters</u>								
ENGLNG1SRTWAFCS	32-1/2" x 31-1/2" x 30"	75	\$3,675	\$3,568	\$3,853	\$4,425	\$5,209	\$5,494

Note: All Lounge Chairs have a 18-1/2" Seat Height and a 24-1/2" Arm Height.

Fabric Requirements: 4-1/2 yards per chair, Non-directional, 54" wide.

Loveseat								
<u>Upholstered Loveseat, No Wood Arm Caps, No Casters</u>								
ENGLNG2SS	32-1/2" x 53-1/2" x 30"	90	\$3,951	\$3,837	\$4,144	\$4,758	\$5,601	\$5,907
<u>Upholstered Loveseat with Wood Arm Caps and No Casters</u>								
ENGLNG2SWAS	32-1/2" x 53-1/2" x 30"	90	\$4,317	\$4,191	\$4,528	\$5,198	\$6,120	\$6,456

Note: All Lounge Chairs have a 18-1/2" Seat Height and a 24-1/2" Arm Height.

Fabric Requirements: 8 yards per chair, Non-directional, 54" wide.

Please specify Wood Finish (Table 1), High-Pressure Laminate; if applicable (Table 2) and Upholstery (Table 5).
Details can be found on pages GEN 4 and GEN 5.

General Specifications

INNER CORE

Inner core is constructed using High-Density compressed foam.

BASE

Base is constructed using 1/2" thick Birch Support Board.



GLIDES

Seats are equipped with 1/4" thick x 7/8" diameter nylon glides.

UPHOLSTERY MATERIALS AND FABRICS

Brodart fabric selections and polyurethane foam are fire rated.

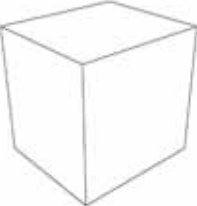



Fabrics which meet Calif. Technical Bulletin #133 are available.

Catalog No.	Overall H x W x D	Wt. (lbs.)	COM Price	Grade 1 Price	Grade 2 Price	Grade 3 Price	Grade 4 Price	Grade 5 Price	
<u>Rectangle Ottoman</u>									Rectangle Ottoman
BROF001S	17-1/4" x 18" x 16"	10	\$585	\$542	\$792	\$882	\$977	\$1,068	
<i>Fabric Requirements: 3 yards per ottoman, Non-directional, 54" wide.</i>									
<u>Crescent Ottoman</u>									Crescent Ottoman
BROF003S	17-1/4" x 18" x 18"	10	\$585	\$542	\$792	\$882	\$977	\$1,068	
<i>Fabric Requirements: 3 yards per ottoman, Non-directional, 54" wide.</i>									
<u>Round Ottoman</u>									Round Ottoman
BROF005S	17-1/4" x 18" x 18"	10	\$585	\$542	\$792	\$882	\$977	\$1,068	
<i>Fabric Requirements: 3 yards per ottoman, Non-directional, 54" wide.</i>									

Please specify Upholstery (Table 5). Details can be found on page GEN 5.

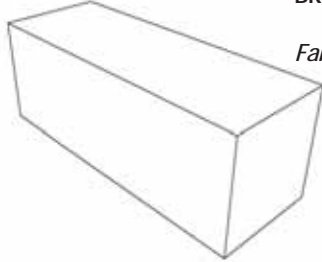
Lounge Furniture

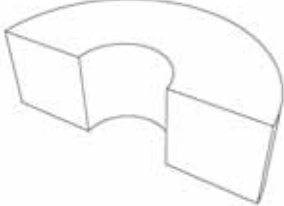
Cirro Soft Seating

	Catalog No.	Overall H x W x D	Wt. (lbs.)	COM Price	Grade 1 Price	Grade 2 Price	Grade 3 Price	Grade 4 Price	Grade 5 Price
Pentagon Ottoman 	<u>Pentagon Ottoman</u> BROF007S	17-1/4" x 26" x 24"	15	\$877	\$817	\$1,117	\$1,214	\$1,364	\$1,531
<i>Fabric Requirements: 4 yards per ottoman, Non-directional, 54" wide.</i>									
Bench 	<u>Bench</u> BROF009S	17-1/4" x 48" x 18"	26	\$1,537	\$1,447	\$1,777	\$1,904	\$2,084	\$2,281
<i>Fabric Requirements: 3 yards per bench, Non-directional, 54" wide.</i>									
Quarter Round Ottoman 	<u>Quarter Round Ottoman</u> BROF011S	17-1/4" x 27" x 18"	15	\$1,249	\$1,189	\$1,489	\$1,586	\$1,736	\$1,903
<i>Fabric Requirements: 3 yards per ottoman, Non-directional, 54" wide.</i>									
Half Round Ottoman 	<u>Half Round Ottoman</u> BROF013S	17-1/4" x 54" x 18"	25	\$2,272	\$2,137	\$2,737	\$3,012	\$3,232	\$3,377
<i>Fabric Requirements: 6 yards per ottoman, Non-directional, 54" wide.</i>									
Arc Ottoman 	<u>Arc Ottoman</u> BROF015S	17-1/4" x 38" x 18"	15	\$1,505	\$1,410	\$1,740	\$1,867	\$2,047	\$2,244
<i>Fabric Requirements: 4 yards per ottoman, Non-directional, 54" wide.</i>									

Please specify Upholstery (Table 5). Details can be found on page GEN 5.

Catalog No.	Overall H x W x D	Wt. (lbs.)	COM Price	Grade 1 Price	Grade 2 Price	Grade 3 Price	Grade 4 Price	Grade 5 Price	
BROF038S	17-1/4" x 60" x 60"	60	\$3,949	\$3,599	\$4,549	\$4,949	\$5,249	\$5,499	Daisy Set (24" Center Round with 5 Crescents)

Fabric Requirements: 18 yards per Complete Daisy Set, Non-directional, 54" wide.



Please specify Upholstery (Table 5). Details can be found on page GEN 5.

Cabinets



2017 Price List and Specifications

Brodart Co. Contract Furniture - Made in USA

280 North Road, Clinton County Industrial Park • McElhattan, PA 17748

Toll-Free: 888-521-1884 • E-Mail: furniture@brodart.com • www.brodartfurniture.com

General Specifications

TOPS

When specified, optional tops will be 1-3/16" thick, 3-ply 45# particleboard grade M2 or better with a top surface of .050" thick, high-pressure laminate and a backing sheet not less than .020" thick for balanced construction. High-pressure laminate will be log-lam finish resistant to scratches, fading, and staining that meets or exceeds NEMA standards. Top will receive bands on one long and two short edges. Edges will be solid Northern-grown Red Oak or Maple. The edge band will be a flush design 5/8" thick x 1-3/16", of specified profile design, externally banded with a 1/4" radius at corners.

SUBTOP

The cabinet will receive two (2) 3/4" x 6" 7-ply, furniture grade veneer-core hardwood plywood rails in the top (front and rear) of the cabinet. The rails will be doweled and pocket screwed to the end panels to complete construction of the cabinet. The sub top rails will anchor the top to the cabinet.

END PANEL

End panels will be 3/4" thick, 7-ply, furniture grade veneer-core hardwood plywood, with plain-sliced slip matched Northern-grown Red Oak or Maple veneer on both sides. Exposed edges are externally banded with a 3/4" x 1.5mm solid, Northern-grown Red Oak or Maple veneer edge band. When specified, the end panel receives 32mm boring for shelf adjustment. The end panels and sub top will be joined with dowel pin construction and pocket screws. Each panel will receive two (2) 3/4" nylon nail glides.

BASE

The cabinet will receive a 3/4" Thick x 4" high 7-ply, furniture-grade veneer-core hardwood plywood base rail in the front and rear of the cabinet. The rails will be doweled and pocket screwed to the end panels to complete construction of the cabinet. Exposed edges will be externally banded with a 3/4" x 1.5mm solid, Northern-grown Red Oak or maple veneer edge band. Base rails will be positioned inside the end panels of the cabinet.

BACK PANEL

The back panel will be 3/4" thick, 7-ply furniture-grade plywood with plain sliced Northern-grown Red Oak or Maple veneers. The top and end panels will receive a dado which captures the back panel on three sides. The back will receive six (6) 5/8"- #8 Philips pan head screws fastened to the hanger rails and end panels. The back panel will rest on the base rail.

DOOR

When specified, doors will be 3/4" thick, 7-ply furniture-grade veneer-core hardwood plywood with plain-sliced slip matched Northern-grown Red Oak or Maple veneer on both sides. Exposed edges will be externally banded with a 3/4" x 1.5mm thick solid, Northern-grown Red Oak or maple veneer edge band. Each door receives two (2) European hinges and one four inch flat black wire pull. A solid oak or maple door stop, 3/4" thick x 2-1/8"H is placed at the top and bottom of the wardrobe and runs the entire width of the cabinet. Doors will be 3/4" half overlay in the cabinet.

SHELVES

When specified, shelves will be 3/4" thick, 7-ply, furniture-grade veneer-core hardwood plywood, with plain-sliced slip matched Northern-grown Red Oak or maple veneer on both sides. Exposed edges are externally banded with a 3/4" x 1.5mm thick solid, Northern-grown Red Oak or maple veneer edge band.

SPACER RAIL





When specified, cabinets with drawers will receive spacer rails placed between drawers for structural support and as a drawer stop. Rails are 1" thick furniture-grade veneer-core hardwood plywood. The rails will be doweled and pocket screwed to the end panels to complete construction of the cabinet.

HANGER RAIL

The cabinet will receive a 3/4" x 4" 7-ply, furniture-grade veneer-core hardwood plywood rail in the top, bottom and middle rear of the cabinet. The rails will be doweled and pocket screwed to the end panels to complete construction of the cabinet. Hanger rails will be positioned inside the end panels of the desk module.

DRAWER

When specified, drawers will be constructed of solid hardwood with 1/4" thick wood bottom panel. Drawers will have 3-ply particleboard fronts with select Northern-grown Red Oak or Maple face veneer. Drawers will receive full extension slides with 100# load capacity and one four inch flat black wire pull.

Oak Catalog No.	Maple Catalog No.	Description	H x W x D	Wt. (lbs.)	Oak Price	Maple Price	
<i>32"H Unit with 1 Door with Lock, 1 Adjustable Shelf</i>							1 Door Cabinet
CBO241832DRS	CBM241832DRS	Cabinet with Right Opening Door	32" x 18" x 24"	116	\$1,124	\$1,225	
CBO241832DLS	CBM241832DLS	Cabinet with Left Opening Door	32" x 18" x 24"	116	\$1,124	\$1,225	
<i>32"H Unit with 2 Doors with Lock, 1 Adjustable Shelf</i>							2 Door Cabinet
CBO242432DS	CBM242432DS	Cabinet with 2 Doors	32" x 24" x 24"	134	\$1,368	\$1,491	
CBO243032DS	CBM243032DS	Cabinet with 2 Doors	32" x 30" x 24"	134	\$1,445	\$1,576	
CBO243632DS	CBM243632DS	Cabinet with 2 Doors	32" x 36" x 24"	134	\$1,549	\$1,688	
CBO244232DS	CBM244232DS	Cabinet with 2 Doors	32" x 42" x 24"	134	\$1,617	\$1,762	
<i>32"H Unit with 1 Pull Out Drawer and 1 Door with Lock, 1 Adjustable Shelf</i>							1 Door Storage Cabinet
CBO241832PDDRS	CBM241832PDDRS	Cabinet with Pull Out Drawer, Right Opening Door	32" x 18" x 24"	136	\$1,455	\$1,586	
CBO241832PDDL	CBM241832PDDL	Cabinet with Pull Out Drawer, Left Opening Door	32" x 18" x 24"	136	\$1,455	\$1,586	
<i>32"H Unit with 2 Pull Out Drawers and 2 Doors</i>							2 Door Storage Cabinet
CBO242432PDDS	CBM242432PDDS	Cabinet with 2 Pull Out Drawers, 2 Doors	32" x 24" x 24"	134	\$1,999	\$2,179	
CBO243032PDDS	CBM243032PDDS	Cabinet with 2 Pull Out Drawers, 2 Doors	32" x 30" x 24"	134	\$2,180	\$2,376	
CBO243632PDDS	CBM243632PDDS	Cabinet with 2 Pull Out Drawers, 2 Doors	32" x 36" x 24"	134	\$2,313	\$2,521	
<i>Work Surface for Base Cabinets with Subtop</i>							Work Surface for Base Cabinets with Subtop
		Work Surface per Square Foot			\$58	\$64	
		Mitered Corner per Corner			\$409	\$446	

Note: Price listed is for any standard Brodart 5/8" flush edge band profile. Please specify on order.

Please specify Wood Finish (Table 1). Details can be found on page GEN 4.

General Specifications

TOPS

Standard top will be 3/4" thick, 7-ply furniture-grade veneer-core hardwood plywood with plain-sliced slip matched Northern-grown Red Oak or Maple veneer on both sides. Exposed edges will be externally banded with a 3/4" x 1.5mm solid, Northern-grown Red Oak or maple veneer edge band.

END PANEL

End panel will be 3/4" thick, 7-ply, furniture-grade veneer-core hardwood plywood, with plain-sliced slip matched Northern-grown Red Oak or Maple veneer on both sides. Exposed edges will be externally banded with a 3/4" x 1.5mm solid, Northern-grown Red Oak or Maple veneer edge band. The end panel will receive 32mm boring for shelf adjustment. The end panels, top and base will be joined with dowel pin construction and pocket screws.

BASE

Standard base will be 3/4" thick, 7-ply furniture-grade veneer-core hardwood plywood with plain-sliced slip matched Northern-grown Red Oak or maple veneer on both sides. Exposed edges will be externally banded with a 3/4" x 1.5mm solid, Northern-grown Red Oak or maple veneer edge band.

BACK PANEL

The back panel will be 1/4" thick, 3-ply furniture-grade plywood with plain sliced Northern-grown Red Oak or maple veneers. The top, base and end panels will receive a dado which captures the back panel on four sides. The back will be glued and pin tacked to the hanger rails.

HANGER RAIL

The cabinet will receive 3/4" x 4" 7-ply, furniture-grade veneer-core hardwood plywood rail in the top, middle and bottom rear of the cabinet. The rails will be doweled and pocket screwed to the end panels to complete construction of the cabinet. Hanger rails will be positioned inside the end panels of the desk module.

DOOR

When specified, doors will be 3/4" thick, 7-ply furniture-grade veneer-core hardwood plywood with plain-sliced slip matched Northern-grown Red Oak or maple veneer on both sides. Exposed edges will be externally banded with a 3/4" x 1.5mm thick solid, Northern-grown Red Oak or maple veneer edge band. Each door will receive two (2) European hinges and one four inch flat black wire pull. A solid oak or maple door stop, 3/4" thick x 2-1/8"H will be placed at the top and bottom of the wardrobe and run the entire width of the cabinet. Doors will be 3/4" half overlay in the cabinet.

SHELVES

Shelves will be 3/4" thick, 7-ply, furniture-grade veneer-core hardwood plywood, with plain-sliced slip matched Northern-grown Red Oak or maple veneer on both sides. Exposed edges will be externally banded with a 3/4" x 1.5mm thick solid, Northern-grown Red Oak or maple veneer edge band.

Oak Catalog No.	Maple Catalog No.	Description	H x W x D	Wt. (lbs.)	Oak Price	Maple Price
24"H Unit with 1 Door with Lock, 1 Adjustable Shelf						
1 Door Wall Cabinet						
CW0121824DRS	CWM121824DRS	Cabinet with Right Opening Door	24" x 18" x 12-3/4"	48	\$1,232	\$1,343
CW0121824DLS	CWM121824DLS	Cabinet with Left Opening Door	24" x 18" x 12-3/4"	48	\$1,232	\$1,343
30"H Unit with 1 Door with Lock, 1 Adjustable Shelf						
CW0121830DRS	CWM121830DRS	Cabinet with Right Opening Door	30" x 18" x 12-3/4"	48	\$1,296	\$1,413
CW0121830DLS	CWM121830DLS	Cabinet with Left Opening Door	30" x 18" x 12-3/4"	48	\$1,296	\$1,413
24"H Unit with 2 Doors with Lock, 1 Adjustable Shelf						
2 Door Wall Cabinet						
CW0122424DS	CWM122424DS	Cabinet with 2 Doors	24" x 24" x 12-3/4"	59	\$1,274	\$1,389
CW0123024DS	CWM123024DS	Cabinet with 2 Doors	24" x 30" x 12-3/4"	70	\$1,527	\$1,665
CW0123624DS	CWM123624DS	Cabinet with 2 Doors	24" x 36" x 12-3/4"	81	\$1,671	\$1,822
30"H Unit with 2 Doors with Lock, 1 Adjustable Shelf						
CW0122430DS	CWM122430DS	Cabinet with 2 Doors	30" x 24" x 12-3/4"	59	\$1,341	\$1,462
CW0123030DS	CWM123030DS	Cabinet with 2 Doors	30" x 30" x 12-3/4"	70	\$1,595	\$1,739
CW0123630DS	CWM123630DS	Cabinet with 2 Doors	30" x 36" x 12-3/4"	81	\$1,717	\$1,872
24"H Open Wall Cabinet without Door, 1 Adjustable Shelf						
Open Wall Cabinet						
CW0121824S	CWM121824S	Cabinet without Doors	24" x 18" x 12"	39	\$875	\$954
CW0122424S	CWM122424S	Cabinet without Doors	24" x 24" x 12"	49	\$911	\$993
CW0123024S	CWM123024S	Cabinet without Doors	24" x 30" x 12"	59	\$999	\$1,090
CW0123624S	CWM123624S	Cabinet without Doors	24" x 36" x 12"	69	\$1,042	\$1,135
30"H Open Wall Cabinet without Door, 1 Adjustable Shelf						
CW0121830S	CWM121830S	Cabinet without Doors	30" x 18" x 12"	44	\$938	\$1,022
CW0122430S	CWM122430S	Cabinet without Doors	30" x 24" x 12"	54	\$975	\$1,063
CW0123030S	CWM123030S	Cabinet without Doors	30" x 30" x 12"	64	\$1,052	\$1,146
CW0123630S	CWM123630S	Cabinet without Doors	30" x 36" x 12"	74	\$1,093	\$1,191

1 Door Wall Cabinet



2 Door Wall Cabinet



Open Wall Cabinet



Please specify Wood Finish (Table 1). Details can be found on page GEN 4.

General Specifications

TOPS

Standard top will be 3/4" thick, 7-ply furniture-grade veneer-core hardwood plywood with plain-sliced slip matched Northern-grown Red Oak or Maple veneer on both sides. Exposed edges will be externally banded with a 3/4" x 1.5mm solid, Northern-grown Red Oak or Maple veneer edge band. Top will be positioned over and flush with the outside edges of the end panels.

END PANEL

End panel will be 3/4" thick, 7-ply, furniture-grade veneer-core hardwood plywood, with plain-sliced slip matched Northern-grown Red Oak or Maple veneer on both sides. Exposed edges will be externally banded with a 3/4" x 1.5mm solid, Northern-grown Red Oak or maple veneer edge band. The end panels and top will be joined with 12-gauge angled metal brackets 3/4" x 3/4" screwed to the inside surface of the panel and top. Each panel will receive two (2) 3/4" nylon nail glides.

INTERMEDIATE PANEL

When specified, intermediate panel will be 3/4" thick, 7-ply, furniture-grade veneer-core hardwood plywood, with plain-sliced slip matched Northern-grown Red Oak or maple veneer on both sides. Exposed edges will be externally banded with a 3/4" x 1.5mm thick solid, Northern-grown Red Oak or Maple veneer edge band.

BASE

The cabinet base will receive a 3/4" x 4" 7-ply, furniture-grade veneer-core hardwood plywood rail in the front and rear of the cabinet. The rails will be doweled and pocket screwed to the end panels to complete construction of the cabinet. Exposed edges will be externally banded with a 3/4" x 1.5mm thick solid, Northern-grown Red Oak or maple veneer edge band. Base rails will be positioned inside the end panels of the desk module.

BACK PANEL

The back panel will be 1/4" thick, 3-ply furniture-grade plywood with plain sliced Northern-grown Red Oak or Maple veneers. The top and end panels will receive a dado which captures the back panel on three sides. The back will receive ten (10) 5/8"- #8 Philips pan head screws fastened to the hanger rails and end panels. The back panel will rest on the base rail.

SHELF

Shelf will be 3/4" thick, 7-ply, furniture-grade veneer-core hardwood plywood, with plain-sliced slip matched Northern-grown Red Oak or maple veneer on both sides. Exposed edge on the front side of the shelf will be externally banded with a 3/4" x 1.5mm solid, Northern-grown Red Oak or Maple veneer edge band. The shelf will be secured with 12-gauge angled metal brackets 3/4" x 3/4" screwed to the inside surface of the panel and top.

CLOTHES BAR



When specified, a solid 1-1/4" diameter Birch dowel rod clothes bar will be placed below the fixed shelf and spans the full width of the wardrobe. The bar will be secured by two (2) 2-1/2" x 2-7/32" round pole sockets. The sockets will be fastened to the end panel with wood screws.

HANGER RAIL

The cabinet will receive a 3/4" x 4" 7-ply, furniture-grade veneer-core hardwood plywood rail in the top, bottom and middle rear of the cabinet. The rails will be doweled and pocket screwed to the end panels to complete construction of the cabinet. Hanger rails will be positioned inside the end panels of the desk module.

DOORS

Doors will be 3/4" thick, 7-ply furniture-grade veneer-core hardwood plywood with plain-sliced slip matched Northern-grown Red Oak or Maple veneer on both sides. Exposed edges opposite the hinges will be externally banded with a 3/4" x 1.5mm thick solid, Northern-grown Red Oak or Maple veneer edge band. Each door will receive three (3) black five knuckle institutional hinges and one four inch flat black wire pull. A solid oak or maple door stop, 3/4" thick x 2-1/8"H will be placed at the top and bottom of the wardrobe and runs the entire width of the cabinet. Doors will be inset in the cabinet.

Oak Catalog No.	Maple Catalog No.	Description	H x W x D	Wt. (lbs.)	Oak Price	Maple Price	
<i>82"H Unit with 4 Adjustable Shelves and 1 Fixed Shelf</i>							Storage Cabinet
CSO242482DS	CSM242482DS	Cabinet with 2 Doors & Locks	82" x 24" x 24"	234	\$2,626	\$2,863	
CSO243082DS	CSM243082DS	Cabinet with 2 Doors & Locks	82" x 30" x 24"	266	\$3,046	\$3,319	
CSO243682DS	CSM243682DS	Cabinet with 2 Doors & Locks	82" x 36" x 24"	298	\$3,206	\$3,494	
<i>72"H Unit with 4 Adjustable Shelves and 1 Fixed Shelf</i>							
CSO242472DS	CSM242472DS	Cabinet with 2 Doors & Locks	72" x 24" x 24"	226	\$2,522	\$2,748	
CSO243072DS	CSM243072DS	Cabinet with 2 Doors & Locks	72" x 30" x 24"	258	\$2,924	\$3,187	
CSO243672DS	CSM243672DS	Cabinet with 2 Doors & Locks	72" x 36" x 24"	290	\$3,078	\$3,355	
<i>82"H Unit with 2 Adjustable Shelves and Coat Rod</i>							Storage Cabinet
CSO242482SCDS	CSM242482SCDS	Cabinet with 2 Doors & Locks	82" x 24" x 24"	201	\$2,465	\$2,687	
<i>72"H Unit with 2 Adjustable Shelves and Coat Rod</i>							
CSO242472SCDS	CSM242472SCDS	Cabinet with 2 Doors & Locks	72" x 24" x 24"	193	\$2,366	\$2,579	
<i>82"H Unit with Partitions, 3 Adjustable Shelves, 1 Fixed Shelf and Coat Rod</i>							Storage Cabinet with Partitions
CSO242482SPCDS	CSM242482SPCDS	Cabinet with 2 Doors & Locks	82" x 24" x 24"	241	\$2,854	\$3,111	
CSO243082SPCDS	CSM243082SPCDS	Cabinet with 2 Doors & Locks	82" x 30" x 24"	273	\$3,403	\$3,710	
CSO243682SPCDS	CSM243682SPCDS	Cabinet with 2 Doors & Locks	82" x 36" x 24"	306	\$3,524	\$3,841	
<i>72"H Unit with Partitions, 3 Adjustable Shelves, 1 Fixed Shelf and Coat Rod</i>							
CSO242472SPCDS	CSM242472SPCDS	Cabinet with 2 Doors & Locks	72" x 24" x 24"	233	\$2,740	\$2,987	
CSO243072SPCDS	CSM243072SPCDS	Cabinet with 2 Doors & Locks	72" x 30" x 24"	265	\$3,267	\$3,561	
CSO243672SPCDS	CSM243672SPCDS	Cabinet with 2 Doors & Locks	72" x 36" x 24"	298	\$3,384	\$3,688	

Please specify Wood Finish (Table 1). Details can be found on page GEN 4.

Display Furniture



2017 Price List and Specifications

Brodart Co. Contract Furniture - Made in USA

280 North Road, Clinton County Industrial Park • McElhattan, PA 17748

Toll-Free: 888-521-1884 • E-Mail: furniture@brodart.com • www.brodartfurniture.com

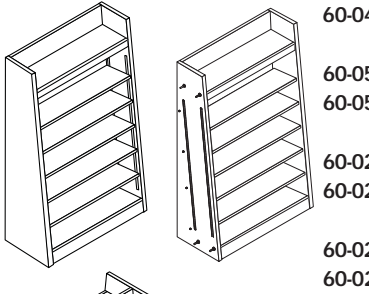
	Oak Catalog No.	Maple Catalog No.	Description	H x W x D	Wt. (lbs.)	Oak Price	Maple Price
A-Frame Shelving 	60-048-S00 OAK	60-048-S00 MAP	Single-Faced Starter	42" x 37-1/8" x 16-3/4"	107	\$1,753	\$1,911
	60-049-S00 OAK	60-049-S00 MAP	Single-Faced Adder	42" x 36-3/16" x 16-3/4"	107	\$1,528	\$1,665
	60-050-S00 OAK	60-050-S00 MAP	Single-Faced Starter	60-1/2" x 37-1/8" x 16-3/4"	148	\$2,119	\$2,310
	60-051-S00 OAK	60-051-S00 MAP	Single-Faced Adder	60-1/2" x 36-3/16" x 16-3/4"	148	\$1,801	\$1,963
	60-022-S00 OAK	60-022-S00 MAP	Double-Faced Starter	42" x 37-1/8" x 33-5/8"	214	\$2,925	\$3,188
	60-023-S00 OAK	60-023-S00 MAP	Double-Faced Adder	42" x 36-3/16" x 33-5/8"	184	\$2,648	\$2,886
	60-024-S00 OAK	60-024-S00 MAP	Double-Faced Starter	60-1/2" x 37-1/8" x 33-5/8"	296	\$3,733	\$4,069
	60-025-S00 OAK	60-025-S00 MAP	Double-Faced Adder	60-1/2" x 36-3/16" x 33-5/8"	248	\$3,001	\$3,270

The a-frame panels are tapered for style and made of 1" thick, 3-ply veneered particleboard with solid oak or maple hardwood edge banding. Shelves are 3/4" thick, 10"D solid oak or maple hardwood. Middle shelves adjust on clip-and-strip hardware and are slightly angled to the rear.

Slatwall End Panels 	60-245-S00 OAK	60-245-S00 MAP	Slatwall End Panel For Double-Faced A-Frame Display	42" x 41-7/8" x 33-1/2"	60	\$1,023	\$1,115
	60-246-S00 OAK	60-246-S00 MAP	Slatwall End Panel For Double-Faced A-Frame Display	60-1/2" x 60-3/8" x 33-1/2"	65	\$1,117	\$1,218

Panel is constructed of 3/4" thick slatwall with 1/4" thick solid wood trim.

Mobile Bookstore Displayer with Storage 	60-056-S00 OAK	60-056-S00 MAP	Mobile Bookstore Displayer with Storage Unit	54" x 39-3/16" x 55-5/8"	289	\$5,669	\$6,180
--	----------------	----------------	---	--------------------------	-----	---------	---------

This bookstore style shelving is constructed using quality wood materials. The flat base area is 11"D and can be used as an additional display area. The ends of the display are provided with slatwall panels. The unit includes six adjustable shelves 3/4"H x 10"D, two fixed top shelves and two fixed base shelves.

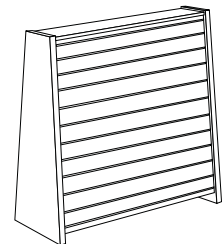
Double-Faced A-Frame Slatwall 	60-738-S00 OAK	60-738-S00 MAP	Double-Faced Frame Slatwall with Casters	54" x 39-3/16" x 55-5/8"	289	\$3,434	\$3,744
	60-739-S00 OAK	60-739-S00 MAP	Double-Faced Frame Slatwall without Casters	54" x 39-3/16" x 55-5/8"	289	\$3,106	\$3,386

Constructed using furniture-grade veneered 3-ply wood with solid oak or maple hardwood edge banding. Slatwall panels are 47-3/4"W x 47-1/2"H (each panel). A 4-1/2"H black toe kick is on two long sides.

Please specify Wood Finish (Table 1). Details can be found on page GEN 4.

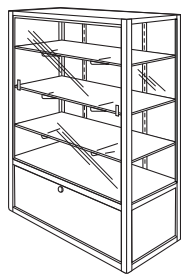
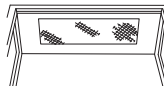
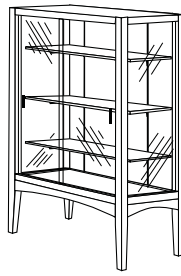
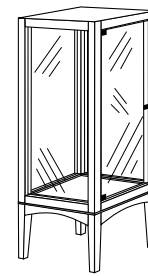
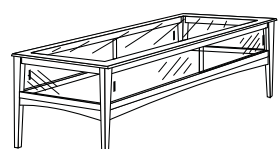
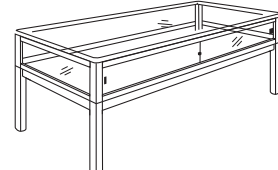
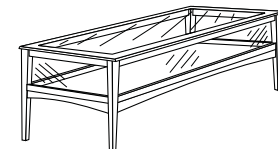
Oak Catalog No.	Maple Catalog No.	Description	H x W x D	Wt. (lbs.)	Oak Price	Maple Price	
60-452-S00 OAK	60-452-S00 MAP	Classic Display Case	82" x 48" x 20"	400	\$10,373	\$11,307	<p>Classic Display Case</p> 
60-453-S00 OAK	60-453-S00 MAP	Classic Display Case	72" x 48" x 20"	380	\$10,027	\$10,929	
		<p>Freestanding case has adjustable tempered plate glass shelves, tempered glass sides, and sliding doors, with lock. Base of unit features a lockable storage compartment 17"H. Solid-wood frames are tenoned together to ensure stability. Equipped with adjustable glides.</p>					
60-456-S00 OAK	60-456-S00 MAP	Optional Lighting		5	\$789	\$860	
		<p>Wood construction finished to match case. Includes a fluorescent lamp, plastic diffuser panel, and an on-off switch mounted into the top enclosure panel.</p>					
60-168-S00 OAK	60-168-S00 MAP	Leg Base Exhibit Case with 3 adjustable shelves.	82" x 48" x 20"	320	\$8,193	\$8,930	<p>Leg Base Exhibit Case and Cube Display Case</p> 
		<p>This case has lockable sliding doors at the front with two stationary side panels constructed of 1/4" thick glass; doors include a lock. Shelves are constructed of 1/4" tempered glass. Back panel is wood.</p>					
60-169-S00 OAK	60-169-S00 MAP	Cube Display Case	82" x 24" x 24"	185	\$5,654	\$6,162	
		<p>Solid frames are tenoned together for added stability. The side panels and door are 1/4" thick laminated glass; shelves are 1/4" thick tempered glass. The door incorporates a lock for security. The shelves are adjustable on a pin-and-hole system offering flexibility.</p>					
		<p>Both are constructed of solid wood. Each leg is 2" square at the top, tapering to 1-1/2" at the bottom and includes an adjustable leveling glide.</p>					
60-166-S00 OAK	60-166-S00 MAP	Horizontal Exhibit Case, 8"H Display	37" x 72" x 36"	200	\$5,951	\$6,486	<p>Horizontal Exhibit Case</p> 
60-167-S00 OAK	60-167-S00 MAP	Horizontal Exhibit Case, 14"H Display	43" x 72" x 36"	220	\$6,363	\$6,936	
		<p>This case is constructed of solid wood. Each leg is 2" square at the top tapering to 1-1/2" at the bottom and includes an adjustable leveling glide. The case offers lockable sliding doors on one side along with three stationary panels constructed of safety glass. The top is tempered glass for added strength.</p>					
60-454-S00 OAK	60-454-S00 MAP	Horizontal Classic Exhibit Case, 8"H Display	37" x 72" x 36"	200	\$5,817	\$6,340	
		<p>Construction is of solid wood. Frames are tenoned together for added stability. Edges of wood top are radiused 1/2". Legs are 2-1/4" square with a 1/4" radius on all four corners, and are supplied with adjustable leveling glides. Top of case and four sides are tempered glass, with the display surface being felt covered. Lockable sliding glass doors in rear of cabinet allow for easy access.</p>					
60-333-S00 OAK	60-333-S00 MAP	Horizontal Flip Top Exhibit Case, 8"H Display	37" x 72" x 36"	210	\$6,887	\$7,507	<p>Horizontal Exhibit Case</p> 
60-334-S00 OAK	60-334-S00 MAP	Horizontal Flip Top Exhibit Case, 14"H Display	43" x 72" x 36"	240	\$7,321	\$7,981	
		<p>Unit is constructed of solid wood leg base with arched apron. Lockable flip top is constructed of framed-up 1" thick x 4"W pieces of solid wood. Top of case and four sides are tempered glass.</p>					

Please specify Wood Finish (Table 1). Details can be found on page GEN 4.

General Specifications

BOOK SHELF UNIT

Shelves are constructed of 18-gauge metal. Book shelves are flat and 10"D. All units come with an acrylic signage display area at the top of the unit. The viewable display area is 3-1/4"H x 48"W.

MEDIA SHELF UNIT

Shelves are constructed of 18-gauge metal. Media shelves are set at an angle for easy viewing and are 6-1/2"D. Nickel plated wire metal dividers are available for the media shelves and can be inserted in 1-3/4" increments. Media shelves also come with a 1/8" thick acrylic lip that runs the length of the shelf and protrudes above the base of the shelf 2-1/4".

END PANELS

End panels are available in both solid and slatwall configurations. Panels are constructed of 3/4" Veneered Particleboard and banded with 1.6mm edge banding. The panels are mounted to the unit via two 14-gauge metal brackets.

DOUBLE-FACED CAPACITY:

CD:	1200	Elementary Books:	320
DVD:	960	Picture Books:	450
CD w/Security:	1,000	Adult Books:	270
DVD w/Security:	800		

Note: Units 25% longer than traditional display units.

	Oak Catalog No.	Maple Catalog No.	Description	H x W x D	Wt. (lbs.)	Oak Price	Maple Price
Book Unit with 8 Book Shelves, Anti-Sway Bar and Sign Holder	<i>Double-Faced A-Frame Book Unit with Eight (8) 9" Book Shelves, Anti-Sway Bar and Sign Holder</i>						
	GMDDFBS67S	N/A	Double-Faced Starter	67" x 50" x 30"	270	\$3,987	N/A
	GMDDFBA67S	N/A	Double-Faced Adder	67" x 48" x 30"	270	\$3,172	N/A



CD/DVD Unit with 10 DVD/CD Shelves, 90 Wire Dividers, Anit-SwayBar and Sign Holder	<i>Double-Faced A-Frame Unit with Ten (10) DVD/CD Shelves, 90 Wire Dividers and Anti-Sway Bar and Sign Holder</i>						
	GMDDFMS67S	N/A	Double-Faced Starter	67" x 50" x 30"	270	\$4,583	N/A
	GMDDFMA67S	N/A	Double-Faced Adder	67" x 48" x 30"	270	\$3,767	N/A

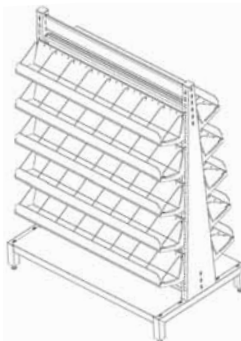

End Panels and Back Panels	<i>End Panels and Back Panels</i>					
	GMDODFPP67S	GMDMDFPP67S	Double-Faced Solid End Panel	270	\$1,156	\$1,260
	GMDODFSP67S	GMDMDFSP67S	Double-Faced Slatwall End Panel	270	\$1,770	\$1,929
	GMDOBP67S	GMDMBP67S	End Panel for 67" H Unit	270	\$220	\$240

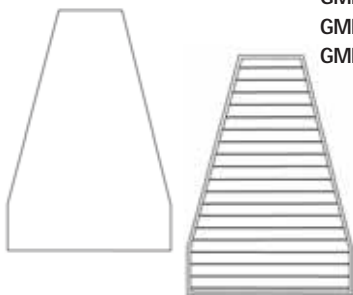

Please specify Wood Finish; if applicable (Table 1) and Metal Color (Table 3).
Details can be found on pages GEN 4 and GEN 5.

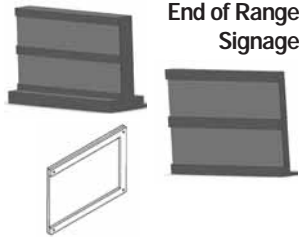
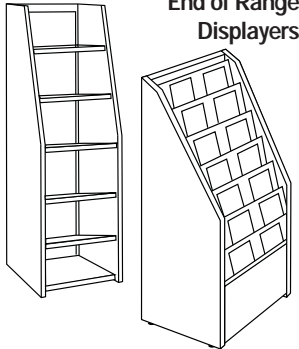
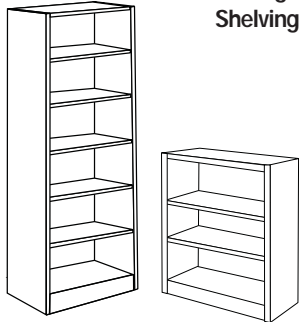
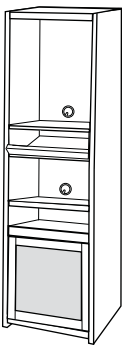
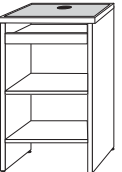
Oak Catalog No.	Maple Catalog No.	Description	H x W x D	Wt. (lbs.)	Oak Price	Maple Price	
64-100-S00 OAK	60-100-S00 MAP	Label Holder for Shelving Top	5-7/8" x 9" x 2-7/8"	1	\$93	\$101	
64-101-S00 OAK	60-101-S00 MAP	Label Holder for Shelving End Panel	5-1/4"H x 9"W	1	\$59	\$63	
63ALH107S	N/A	Acrylic Label Holder	7-1/2"H x 10"W	1	\$73	N/A	
60-013-S00 OAK	60-013-S00 MAP	Book Displayer Has five sloping shelf spaces for displaying books spine out at an angle for easy access. Adjustable shelves are 9"D. End panels are 3/4" thick, veneered particleboard with banded edges and are equipped with adjustable leveling glides. Back and bottom are 3/4" thick particleboard with banded edges.	59" x 19-3/8" x 16"	163	\$1,669	\$1,818	
60-115-S00 OAK	60-115-S00 MAP	Magazine/Newspaper Displayer Displayer provides seven tiers in black wire framing for display of newspapers or magazines. Pockets are 1-1/2"D. End panels are 3/4" thick, veneered particleboard with banded edges and are equipped with adjustable leveling glides. Back and bottom shelf are painted black, with a 15-1/2" clearance above the bottom shelf.	59" x 19-3/8" x 16"	125	\$1,669	\$1,818	
S1-114-S00	1S-114-S00	42"H Shelving has 4 shelves	42" x 20" x 12"	91	\$932	\$1,016	
S1-115-S00	1S-115-S00	42"H Shelving has 4 shelves	42" x 24" x 12"	114	\$944	\$1,030	
S1-116-S00	1S-116-S00	48"H Shelving has 4 shelves	48" x 20" x 12"	101	\$958	\$1,045	
S1-117-S00	1S-117-S00	48"H Shelving has 4 shelves	48" x 24" x 12"	124	\$971	\$1,059	
S1-118-S00	1S-118-S00	60-1/2"H Shelving has 4 shelves	60-1/2" x 20" x 12"	129	\$1,268	\$1,382	
S1-119-S00	1S-119-S00	60-1/2"H Shelving has 4 shelves	60-1/2" x 24" x 12"	160	\$1,280	\$1,395	
S1-120-S00	1S-120-S00	82"H Shelving has 5 shelves	82" x 20" x 12"	165	\$1,372	\$1,495	
S1-121-S00	1S-121-S00	82"H Shelving has 5 shelves	82" x 24" x 12"	204	\$1,384	\$1,509	
		This standard construction shelving is designed for the end of 20"D or 24"D shelving ranges. Shelves are 12"D and constructed of solid hardwood. The upright end panels are 1" thick and utilize the pin-and-hole system to support the wood shelves.					
60-052-S00 OAK	60-052-S00 MAP	Computer Station for Wood Shelving	82" x 24" x 12"	125	\$1,973	\$2,151	
60-053-S00 OAK	60-053-S00 MAP	Computer Station for Metal Shelving	84" x 24" x 12"	135	\$2,165	\$2,359	
		End of range units are standard type construction and are designed for the end of 24" deep shelving. The unit has a locking door on the bottom for computer storage with a perforated metal front for heat ventilation. The top has two adjustable shelves with pin and hole system and adjustable slanted keyboard shelf. The back panel at the top is inset for wire management. The end panels are 1" thick.					
60-012-S00 OAK	60-012-S00 MAP	OPAC Station End of range OPAC unit is designed for the end of 24" deep shelving units. It has a flat work surface for computer monitor with a pull out keyboard shelf. It also has two fixed flat shelves below the pull out shelf. The work surface is HPL with solid wood edges. The end panels are 1-3/16" thick.	40-1/2" x 24" x 16"	110	\$1,318	\$1,438	

Please specify Wood Finish (Table 1). Details can be found on page GEN 4.

	Oak Catalog No.	Maple Catalog No.	Description	H x W x D	Wt. (lbs.)	Oak Price	Maple Price
Newspaper Displayer	60-203-S00 OAK	60-203-S00 MAP	Newspaper Displayer	67" x 28-3/16" x 28-3/16"	100	\$4,143	\$4,516



Constructed of veneered 3/4" plywood using high-quality black plastic corner molding on all vertical edges. Pocket has clear acrylic front for ease of displayed items. The unit includes 16 pockets (8-3/4"H x 21-1/4"W x 2-3/4"D).

Vertical Newspaper Rack	60-180-S00 OAK	60-180-S00 MAP	Vertical Newspaper Racks	62-1/2" x 30-7/8" x 17-3/4"	50	\$1,539	\$1,678
--------------------------------	----------------	----------------	--------------------------	-----------------------------	----	---------	---------

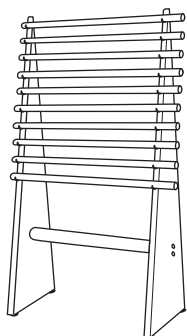

A-frame ends and cross-braces are solid hardwood screwed together. J-hooks hold the ten newspaper sticks which are included.

Wall-Mounted Newspaper Rack	60-969-S00 OAK	60-969-S00 MAP	Wall-Mounted Newspaper Racks	29-1/2" x 2-1/2" x 1-3/4"	17	\$365	\$398
------------------------------------	----------------	----------------	------------------------------	---------------------------	----	-------	-------

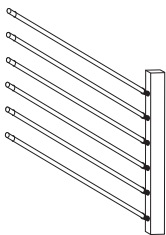

Construction is solid hardwood with six angled holes to receive the sticks which are included. Fastening holes are drilled for front or side mounting.

Magazine Rack	60-868-S00 OAK	60-868-S00 MAP	Magazine Racks	41-1/2" x 35-3/32" x 17-3/16"	200	\$2,131	\$2,322
----------------------	----------------	----------------	----------------	-------------------------------	-----	---------	---------

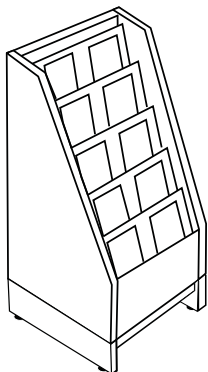

Magazine Racks has six sloped slots for magazine display. The unit is built with apron and leg base construction. The aprons and legs are solid oak or maple hardwood construction.

Please specify Wood Finish (Table 1). Details can be found on page GEN 4.

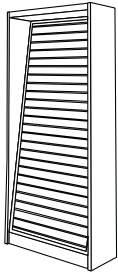
Oak Catalog No.	Maple Catalog No.	Description	Wt. H x W x D	Oak (lbs.)	Maple Price	Price	
S1-113-S00	1S-113-S00	Slatwall Shelving, Starter	60-1/2" x 36" x 12"	96	\$1,763	\$1,922	Slatwall Shelving
S2-113-S00	2S-113-S00	Slatwall Shelving, Adder	60-1/2" x 36" x 12"	81	\$1,327	\$1,446	
S1-112-S00	1S-112-S00	Slatwall Shelving, Starter	82" x 36" x 12"	112	\$1,883	\$2,053	
S2-112-S00	2S-112-S00	Slatwall Shelving, Adder	82" x 36" x 12"	92	\$1,475	\$1,608	

This standard construction shelving unit is fitted with a 3/4" thick slatwall inset panel.

60-070-S00 OAK	60-070-S00 MAP	Three-Sided Slatwall Kiosk Constructed of 1-3/16" thick, 3-ply veneered particleboard and HPL covered slatwall. Base is 8"H, usable slatwall area 54"H x 31"W (each panel).	65-1/8" x 34-3/4" x 30-7/2"	300	\$3,026	\$3,299	Three-Sided Slatwall Kiosk
----------------	----------------	--	-----------------------------	-----	---------	---------	-----------------------------------

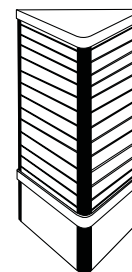

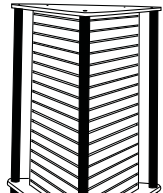
60-800-S00 OAK	60-800-S00 MAP	Three-Sided Multimedia Kiosk Horizontal top and bottom are 1-3/16" thick, 3-ply veneered particleboard with a hardwood veneer edge band. The vertical support rails are 2-1/2" diameter steel tubes. The metal is ASTM A-513 type 2 steel and is 16-gauge. Each vertical support rail has a 2" diameter, self-leveling, adjustable floor glide and attaches to the horizontal top panel using 3/8" bolts. Vertical slatwall panels are 54-1/4"H x 30-3/4"W with a surface of high-pressure laminate. Triangular slatwall display area is attached to the top and bottom horizontal panels using 5/16" bolts fastened to internally and externally threaded bushings. The corners of the slatwall are joined together with a rounded black plastic extrusion.	65-1/8" x 42" x 47-7/8"	325	\$4,330	\$4,720	
----------------	----------------	---	-------------------------	-----	---------	---------	--

60-801-S00 OAK	60-801-S00 MAP	Optional Cork Board for Kiosk Bulletin board is corkboard 1/2" thick. A black metal hanger bracket fastened to internally embedded "T" nuts is mounted on the back so the unit can be easily hung on slatwall. Designed for use with the multimedia kiosk.	15-1/2"H x 30"W	20	\$319	\$348	Optional Bulletin Board
----------------	----------------	---	-----------------	----	-------	-------	--------------------------------



60-037-S00 OAK	60-037-S00 MAP	Four-Sided Slatwall Displayer with Shelves and Casters	42" x 21-1/2" x 20-1/4"	90	\$2,925	\$3,188	Four-Sided Slatwall Displayer with Shelf
60-038-S00 OAK	60-038-S00 MAP	Four-Sided Slatwall Displayer with Shelves (without Casters)	42" x 21-1/2" x 20-1/4"	85	\$2,580	\$2,813	

This unit is provided with two slatwall end panels and two open sides with adjustable shelves. Shelf depth is 9". Includes four 3/4"H adjustable shelves and two base shelves.

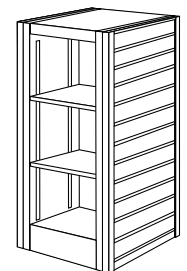

Please specify Wood Finish (Table 1). Details can be found on page GEN 4.

Display Furniture

Specialty/Design Flex Displayers

	Oak Catalog No.	Maple Catalog No.	Description	H x D	Wt. (lbs.)	Oak Price	Maple Price
Specialty Shelving	S1-202-S00	1S-202-S00	FYI Reference Shelving, Starter	42" x 24"	145	\$2,349	\$2,561
	S2-202-S00	2S-202-S00	FYI Reference Shelving, Adder	42" x 24"	125	\$1,977	\$2,155

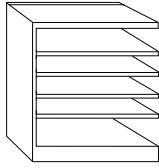
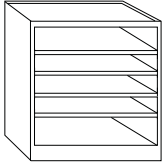

Reference shelving is 42"H in the back and 39"H in the front.
Tops have a 3/4" x 3/4" solid-wood retainer strip on the front edge.
Units have 1/2" thick plywood backs. Shelves are 20-1/2"D.

Serpentine Design Flex Shelving	S1-197-S00	1S-197-S00	Serpentine with Wood Shelves	42"H	400	\$6,417	\$6,994
	S1-186-S00	1S-186-S00	Serpentine with Omega Flat Shelves	42"H	400	\$6,375	\$6,948
	S1-185-S00	1S-185-S00	Serpentine with Omega Divider Shelves	42"H	400	\$7,217	\$7,867
	S1-184-S00	1S-184-S00	Serpentine with Omega Media Display Shelves	42"H	400	\$8,090	\$8,818

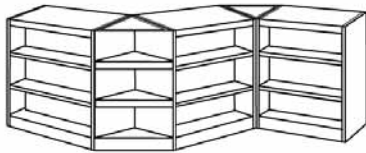

Three Wing Design Flex Shelving	S1-200-S00	1S-200-S00	Three Wing with Wood Shelves	42"H	380	\$5,271	\$5,745
	S1-192-S00	1S-192-S00	Three Wing with Omega Flat Shelves	42"H	380	\$5,230	\$5,701
	S1-191-S00	1S-191-S00	Three Wing with Omega Divider Shelves	42"H	380	\$6,070	\$6,617
	S1-190-S00	1S-190-S00	Three Wing with Omega Media Display Shelves	42"H	380	\$6,943	\$7,568

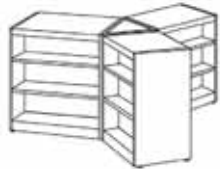

Horseshoe Design Flex Shelving	S1-199-S00	1S-199-S00	Horseshoe with Wood Shelves	42"H	400	\$6,417	\$6,994
	S1-189-S00	1S-189-S00	Horseshoe with Omega Flat Shelves	42"H	400	\$6,375	\$6,948
	S1-188-S00	1S-188-S00	Horseshoe with Omega Divider Shelves	42"H	400	\$7,212	\$7,861
	S1-187-S00	1S-187-S00	Horseshoe with Omega Media Display Shelves	42"H	400	\$8,090	\$8,818

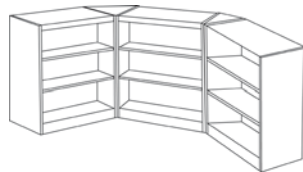

90 Degree Design Flex Shelving	S1-196-S00	1S-196-S00	90 Degree with Wood Shelves	42"H	300	\$4,078	\$4,445
	S1-195-S00	1S-195-S00	90 Degree with Omega Flat Shelves	42"H	300	\$4,047	\$4,411
	S1-194-S00	1S-194-S00	90 Degree with Omega Divider Shelves	42"H	300	\$4,609	\$5,024
	S1-193-S00	1S-193-S00	90 Degree with Omega Media Display Shelves	42"H	300	\$5,192	\$5,660

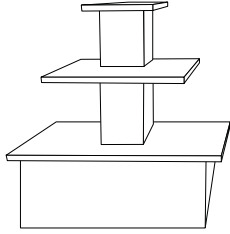
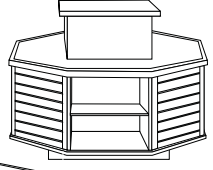
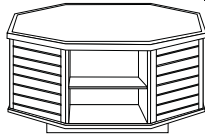
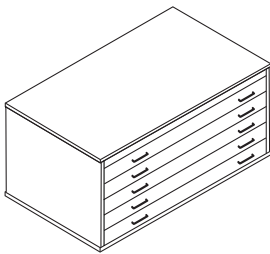
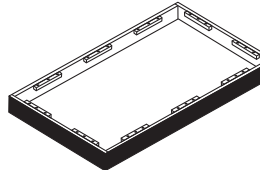
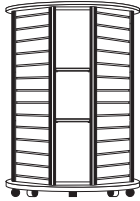
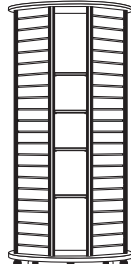

Please specify Wood Finish (Table 1) and High-Pressure Laminate; if applicable (Table 2). Details can be found on page GEN 4.

Oak Catalog No.	Maple Catalog No.	Description	Wt. H x W x D	Oak (lbs.)	Maple Price	Price	
60-228-S00 OAK	60-228-S00 MAP	Large 3-Tier Displayer Constructed of hardwood veneered 3-ply particleboard. This unit offers three display surfaces – the first is 16-5/8" from the floor and is 47-1/2" square. Second is 34" from the floor and is 32" square. Third level is 51" from the floor and is 16" square. A 10" square center column supports the top two levels. The top of each shelf is covered with high-pressure laminate for added protection.	51" x 47-1/2" x 47-1/2"	350	\$2,314	\$2,523	Miscellaneous Displayers 
60-239-S00 OAK	60-239-S00 MAP	Octagonal Displayer with Riser	42" x 48" x 48"	200	\$4,109	\$4,479	
60-239-S07 OAK	60-239-S07 MAP	Mobile Octagonal Displayer with Riser	42" x 48" x 48"	175	\$4,817	\$5,251	
60-242-S00 OAK	60-242-S00 MAP	Octagonal Displayer without Riser	30" x 48" x 48"	200	\$3,548	\$3,867	
60-242-S07 OAK	60-242-S07 MAP	Mobile Octagonal Displayer without Riser	30" x 48" x 48"	175	\$4,258	\$4,641	
		Constructed of 3/4" oak or maple plywood and solids with inset 3/4" slatwall panels. The display surfaces are covered with high-pressure laminate for added durability with solid hardwood edge banding. The display cubes offer 3/4" solid wood shelves adjustable in 32mm increments. The riser is 24" square and 12"H. This unit has a 4"H black toe kick for increased functionality. Mobile versions have 2-1/3" heavy-duty swivel casters.					
60-899-S00 OAK	60-899-S00 MAP	Map Cabinet The cabinet is constructed five drawers high. Drawers have matched fronts, measuring 2-1/2"H x 44"W x 25-1/4"D inside. Drawer fronts are 3-7/8"H, screwed to the solid-wood drawer bodies. Drawer slides on hardwood slide mechanism and has stops to prevent accidental removal. Cabinet top, base, and sides are 3/4" thick, 7-ply veneer-core plywood with hardwood veneers. Cabinet back panel is 1/4" matching plywood. All exposed edges of panels are banded with 1/2" thick, solid hardwood. Cabinets may be stacked.	23-1/4" x 48-1/2" x 28-3/8"	225	\$5,876	\$6,405	
60-900-S00	N/A	Map Cabinet Base Constructed of 3/4" thick, 7-ply veneer-core plywood, the base creates a 4"H recessed, ebonized toe space.	4" x 47-1/4" x 27-3/8"	10	\$307	N/A	
60-303-S00 OAK	60-303-S00 MAP	Mobile Multimedia Kiosk Child Height. 4-slatwall areas that are 11-7/8" wide by 42"H. The 4-shelf areas are 8-1/2" inside width x 42"H with 2-adjustable shelves each area.	46-1/2" x 33" x 33"	175	\$3,483	\$3,797	Mobile Multimedia Displayers 
60-304-S00 OAK	60-304-S00 MAP	Mobile Multimedia Kiosk Four slatwall areas that are 11-7/8"W by 64-1/2"H. The four shelf areas are 8-1/2" inside width x 64-1/2"H with 2 adjustable shelves each area. Both units are constructed of 3/4" thick, 7-ply hardwood with 1.6mm edge bands. Octagon shaped unit with alternating slatwall and adjustable shelf area. The units sit on locking swivel casters.	69" x 33" x 33"	200	\$4,415	\$4,813	

Please specify Wood Finish (Table 1) and High-Pressure Laminate; if applicable (Table 2). Details can be found on page GEN 4.

Display Furniture

Mobile Displayers

	Oak Catalog No.	Maple Catalog No.	Description	H x W x D	Wt. (lbs.)	Oak Price	Maple Price
Mobile Pyramid Displayers	60-307-S00 OAK	60-307-S00 MAP	3-Sided Mobile Pyramid Displayer, Each Side is 38-11/16"W	73" x 38-3/4" x 33-1/2"	195	\$2,942	\$3,207
	60-309-S00 OAK	60-309-S00 MAP	4-Sided Mobile Pyramid Displayer, Each Side is 39"W	73" x 39" x 39"	245	\$3,754	\$4,092

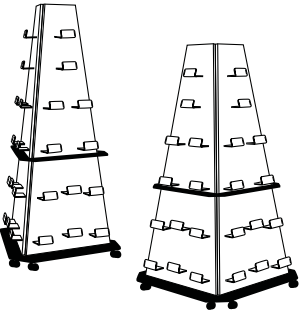

Constructed of 3/4" thick, 3-ply veneered particleboard. These units offers a unique method of display. Available in triangular or square pyramid designs with 2" dual-wheel, swivel locking casters.

Mobile Book Displayers	60-112-S00 OAK	60-112-S00 MAP	Double-Faced Browser with Casters	33-3/4" x 57-3/4" x 35-3/4"	200	\$5,643	\$6,151
	60-113-S00 OAK	60-113-S00 MAP	Single-Faced Browser with Casters	33-3/4" x 57-3/4" x 18-3/4"	175	\$4,025	\$4,387
	60-262-S00 OAK	60-262-S00 MAP	Double-Faced Browser - Small	23" x 25" x 25"	200	\$1,601	\$1,744

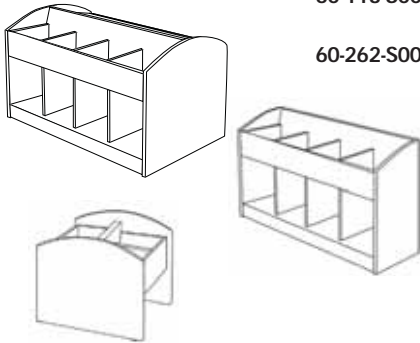

Mobile Bin Browsers	60-263-S00 OAK	60-263-S00 MAP	Single-Faced Mobile Browser with Seat	24-5/8" x 23-3/4" x 25"	140	\$1,850	\$2,017
	60-264-S00 OAK	60-264-S00 MAP	Double-Faced Mobile Browser with Seat	24-5/8" x 45" x 25"	190	\$2,607	\$2,842

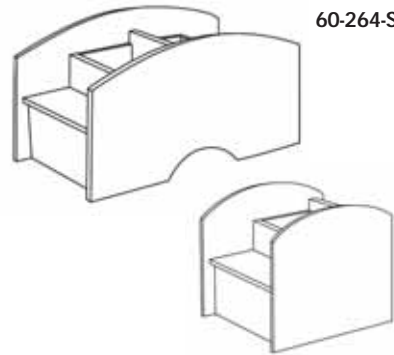

Mobile Magazine/Book Displayer	60-017-S00 OAK	60-017-S00 MAP	Double-Faced Magazine/Book Displayer	60-1/2" x 37-3/16" x 24"	150	\$3,742	\$4,078
---	----------------	----------------	---	--------------------------	-----	---------	---------

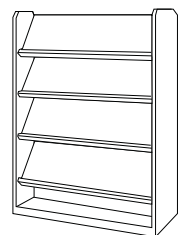

Please specify Wood Finish (Table 1). Details can be found on page GEN 4.

Oak Catalog No.	Maple Catalog No.	Description	H x W x D	Wt. (lbs.)	Oak Price	Maple Price	
60-072-S00 OAK	60-072-S00 MAP	CD Display Center, Starter	42" x 38-3/16" x 20"	110	\$2,902	\$3,164	42"H CD Display Center
60-071-S00 OAK	60-071-S00 MAP	CD Display Center, Adder	42" x 37-3/16" x 20"	90	\$2,676	\$2,917	

Three drawers, approx. capacity is 450 CDs.
 Solid hardwood construction using starter/adder configurations. End panels and intermediates are 3/4" solid hardwood. Each drawer is fully extendable and fitted with a black molded plastic single CD tray (multipack CD tray available upon request).

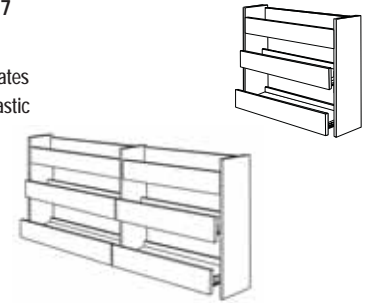

60-075-S00 OAK	60-075-S00 MAP	CD Display Center, Starter	61" x 38-3/16" x 20"	145	\$3,501	\$3,816	61"H CD Display Center
60-074-S00 OAK	60-074-S00 MAP	CD Display Center, Adder	61" x 37-3/16" x 20"	125	\$3,083	\$3,360	

Four drawers, approx. capacity is 600 CDs.
 Solid hardwood construction using starter/adder configurations. End panels and intermediates are 3/4" solid hardwood. Each drawer is fully extendable and fitted with a black molded plastic single CD tray (multipack CD tray available upon request).

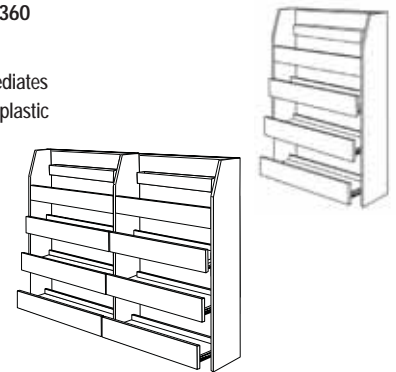

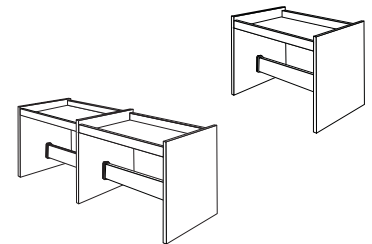

60-751-S00 OAK	60-751-S00 MAP	CD Browser, Starter	39-1/2" x 38-1/4" x 39-3/4"	175	\$2,085	\$2,273	Classic CD Browser
60-752-S00 OAK	60-752-S00 MAP	CD Browser, Adder	39-1/2" x 37-3/8" x 39-3/4"	125	\$1,738	\$1,894	

Constructed of 3/4" thick veneered 3-ply particleboard core with solid hardwood edge banding. Stretcher system is manufactured from solid hardwood. The display area is double-sided and holds approximately 300 CDs per unit in a double-sided black plastic display insert.

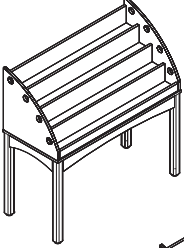
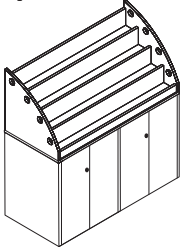
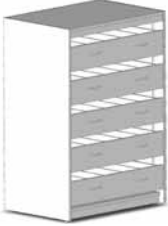

Please specify Wood Finish (Table 1). Details can be found on page GEN 4.

	Oak Catalog No.	Maple Catalog No.	Description	H x W x D	Wt. (lbs.)	Oak Price	Maple Price
CD/DVD Displayer	60-580-S00 OAK	60-580-S00 MAP	CD/DVD Table	49" x 47-3/4" x 21-1/4"	125	\$1,426	\$1,554
			Single side displayer with cascading stair step design and five levels. Constructed of 3/4" thick, 7-ply hardwood with 1.6mm edge bands. The base is leg and apron construction.				
	60-581-S00 OAK	60-581-S00 MAP	CD/DVD Cabinet	52" x 47-3/4" x 21-1/4"	125	\$3,307	\$3,604
			Single side displayer with cascading stair step design and five levels. Constructed of 3/4" thick, 7-ply hardwood with 1.6mm edge bands. The base is a storage cabinet on locking casters. Two sided with four doors. Each side is lockable. Each side has a fixed shelf that is 16" deep and 22-5/8" wide.				
CD/DVD Units	64-771-S00 OAK	64-771-S00 MAP	CD/DVD Drawer Unit	49-5/8" x 34-1/2" x 23-1/8"	250	\$5,462	\$5,954
			Five drawers, approx. capacity is 850 CDs and 600 DVDs. This drawer unit features five drawers installed using full extension slides. Each drawer has five compartments with a metal follower block. Drawers are constructed with a solid wood body and drawer front and a black pull handle. Unit accommodates media 8" tall. The cabinet is constructed using 3/4" thick, 3-ply veneered particleboard.				
CD/DVD Drawer	60-336-S00 OAK	60-336-S00 MAP	CD/DVD Display Unit	49-5/8" x 34-1/2" x 23-1/8"	250	\$5,237	\$5,709
			Five drawers, approx. capacity is 850 CDs and 600 DVDs.				
CD/DVD Display							

Please specify Wood Finish (Table 1). Details can be found on page GEN 4.

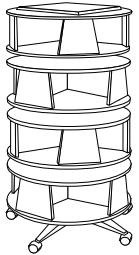
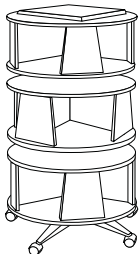
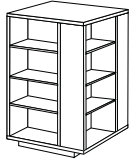
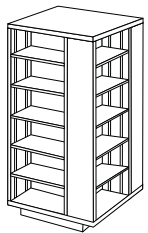
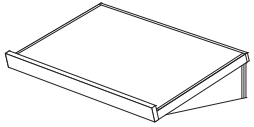
Oak Catalog No.	Maple Catalog No.	Description	H x W x D	Wt. (lbs.)	Oak Price	Maple Price	
60-194-S00	60-234-S00	4-Tier Revolving Displayer with 8-1/2"H Shelves Four tiers with four compartments each holding 752 CDs, 132 books or 368 DVDs up to 9"H. Each compartment is 9"H x 11-3/4"W x 11-3/4"D.	56-1/8" x 27" Diameter	110	\$4,148	\$4,521	<p style="text-align: right;">Revolving Displayers</p>  
60-195-S00	60-235-S00	4-Tier Revolving Displayer with 6-1/2"H Shelves Four tiers with four compartments each holding 752 CDs up to 7"H. Each compartment is 7"H x 11-3/4"W x 11-3/4"D.	56-1/8" x 27" Diameter	110	\$3,860	\$4,207	
60-196-S00	60-236-S00	3-Tier Revolving Displayer with 12-1/2"H Shelves Three tiers with four compartments each holding 132 books up to 13"H. Each compartment is 13"H x 11-3/4"W x 11-3/4"D. These durable displays are constructed of 3/4" solid plywood. Each unit is mounted on a five-prong base with 2" dual-wheel, full swivel locking casters.	56-1/8" x 27" Diameter	110	\$3,728	\$4,064	
60-057-S00 OAK	60-057-S00 MAP	4-Sided Revolving Displayer Holds 272 paperbacks, 1,088 CDs, 272 videocassettes or 544 DVDs.	48" x 27-1/4" x 27-1/4"	299	\$3,137	\$3,419	<p style="text-align: right;">4-Sided Revolving Displayers</p>  
60-058-S00 OAK	60-058-S00 MAP	4-Sided Revolving Displayer Holds 408 paperbacks, 1,632 CDs, 408 videocassettes or 816 DVDs. These displays are constructed of 3/4" thick, 3-ply oak veneered particleboard with solid hardwood edge banding. The adjustable shelves are 17-1/2"W. The units revolve on a 1000# load lazy susan.	66" x 27-1/4" x 27-1/4"	325	\$3,820	\$4,163	
60-854-S00 OAK	60-854-S00 MAP	S/F Revolving Dictionary Stand Rotates 360° for instant patron access. Constructed of 3/4" thick, 7-ply oak or maple hardwood veneer plywood with a 1/4" thick solid edge band on 3-sides and a 1/2" thick x 3/4" W band on the bottom edge. The bottom band has a raised edge that becomes the retainer to hold the book in place.	5-3/4" x 21" x 12"	10	\$426	\$464	<p style="text-align: right;">Revolving Dictionary Stand</p> 

Please specify Wood Finish (Table 1). Details can be found on page GEN 4.

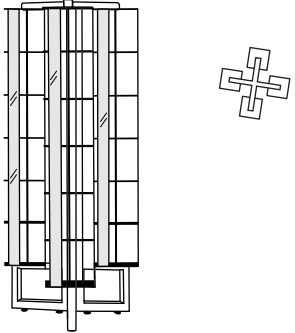
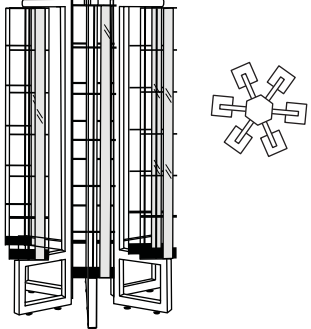
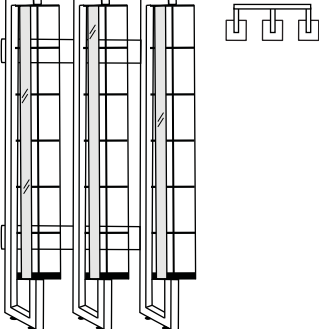
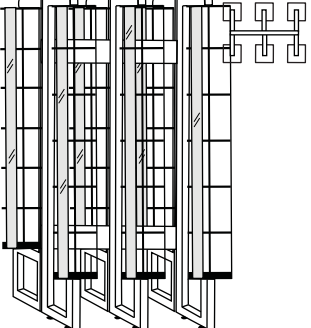
	Oak Catalog No.	Maple Catalog No.	Description	H x W x D	Wt. (lbs.)	Oak Price	Maple Price
Four Tower Island 	60-415-S00 OAK	60-415-S00 MAP	Four Tower Island with Six (6) 8-1/4"H Shelves	68-1/4" x 38" x 38"	136	\$3,050	\$3,325
	60-215-S00 OAK	60-215-S00 MAP	Four Tower Island with Five (5) 10"H Shelves	68-1/4" x 38" x 38"	136	\$2,943	\$3,208
Six Tower Island 	60-416-S00 OAK	60-416-S00 MAP	Six Tower Island with Six (6) 8-1/4"H Shelves	68-1/4" x 42-1/2" x 42-1/2"	210	\$4,882	\$5,321
	60-216-S00 OAK	60-216-S00 MAP	Six Tower Island with Five (5) 10"H Shelves	68-1/4" x 42-1/2" x 42-1/2"	210	\$4,736	\$5,163
Three Tower Wall 	60-417-S00 OAK	60-417-S00 MAP	Three Tower Wall with Six (6) 8-1/4"H Shelves	68-1/4" x 43-7/8" x 17-1/4"	128	\$2,438	\$2,657
	60-217-S00 OAK	60-217-S00 MAP	Three Tower Wall with Five (5) 10"H Shelves	68-1/4" x 43-7/8" x 17-1/4"	128	\$2,368	\$2,581
Six Tower Aisle 	60-418-S00 OAK	60-418-S00 MAP	Six Tower Aisle with Six (6) 8-1/4"H Shelves	68-1/4" x 43-7/8" x 34-1/2"	266	\$4,878	\$5,316
	60-218-S00 OAK	60-218-S00 MAP	Six Tower Aisle with Five (5) 10"H Shelves	68-1/4" x 43-7/8" x 34-1/2"	266	\$4,736	\$5,163

Please specify Wood Finish (Table 1). Details can be found on page GEN 4.

Catalog No.	Description	Overall H x W x D	Wt. (lbs.)	COM Price	Wood/G1 Price	Grade 2 Price	Grade 3 Price	Grade 4 Price	Grade 5 Price
<u>Shelving Bench, Oak Wood</u>									
S1-600-S00	12"D Starter	21"H x 12"D	45	\$923	\$917	\$1,132	\$1,182	\$1,340	\$1,416
S2-600-S00	12"D Adder	21"H x 12"D	45	\$797	\$792	\$978	\$1,019	\$1,156	\$1,223
S1-601-S00	16"D Starter	21"H x 16"D	50	\$997	\$991	\$1,224	\$1,274	\$1,447	\$1,530
S2-601-S00	16"D Adder	21"H x 16"D	50	\$855	\$850	\$1,050	\$1,094	\$1,240	\$1,312
<u>Shelving Bench, Maple Wood</u>									
1S-600-S00	12"D Starter	21"H x 12"D	45	\$971	\$966	\$1,192	\$1,241	\$1,410	\$1,491
2S-600-S00	12"D Adder	21"H x 12"D	45	\$843	\$838	\$1,034	\$1,078	\$1,224	\$1,295
1S-601-S00	16"D Starter	21"H x 16"D	50	\$1,058	\$1,052	\$1,299	\$1,352	\$1,536	\$1,624
2S-601-S00	16"D Adder	21"H x 16"D	50	\$917	\$912	\$1,127	\$1,173	\$1,334	\$1,410

Shelving Benches

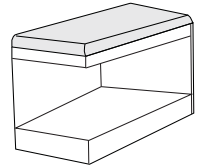
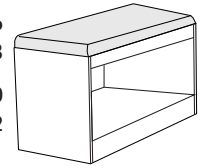

Catalog No.	Description	Overall H x W x D	Wt. (lbs.)	COM Price	Wood/G1 Price	Grade 2 Price	Grade 3 Price	Grade 4 Price	Grade 5 Price
<u>Reader's Roost, Oak Wood</u>									
60-274-S00	Reader's Roost	42" x 85" x 49-1/4"	375	\$6,065	\$6,054	\$7,472	\$7,790	\$8,840	\$9,349
<u>Reader's Roost, Maple Wood</u>									
77-274-S00	Reader's Roost	42" x 85" x 49-1/4"	375	\$6,675	\$5,606	\$8,224	\$8,572	\$9,727	\$10,287

Reader's Roost

Reader's Roost consists of three sections of wood shelving 42"H, with a carpeted platform 19"H. The shelving is oak or maple with 12"D shelves. Capacity: 600 children's books.

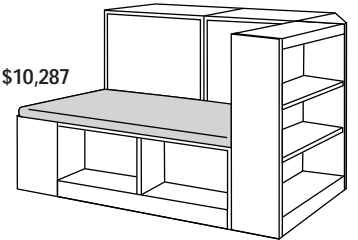

Catalog No.	Description	Overall H x W x D	Wt. (lbs.)	COM Price	Wood/G1 Price	Grade 2 Price	Grade 3 Price	Grade 4 Price	Grade 5 Price
<u>Hassock, Oak Wood</u>									
60-864-S00	Hassock	15" x 15" x 15"	18	\$633	\$628	\$705	\$730	\$916	\$971
<u>Hassock, Maple Wood</u>									
77-864-S00	Hassock	15" x 15" x 15"	18	\$709	\$703	\$790	\$818	\$1,026	\$1,087

Hassocks

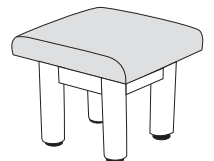

Please specify Wood Finish (Table 1) and Upholstery (Table 5). Details can be found on pages GEN 4 and GEN 5.

Wood Book Trucks



2017 Price List and Specifications

Brodart Co. Contract Furniture - Made in USA

280 North Road, Clinton County Industrial Park • McElhattan, PA 17748

Toll-Free: 888-521-1884 • E-Mail: furniture@brodart.com • www.brodartfurniture.com

General Specifications

Construction is solid hardwood not less than 3/4" thick. Except when indicated, each truck is supplied with two fixed and two swivel carpet casters with 5" diameter tires. Each caster is attached with four lag screws, except as indicated. Caster forks are steel, heat treated, and bright nickel plated. Wheels are gray rubber, 1-9/32"W on ball bearings. Seals and O-rings are used to produce a quiet caster. Load capacity rated at 200# per caster.

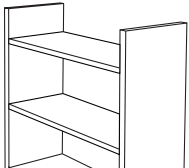
	Oak Catalog No.	Maple Catalog No.	Description	H x W x D	Wt. (lbs.)	Oak Price	Maple Price
	60-911-S01 OAK	60-911-S01 MAP	Large Book Truck with Flat Shelves	43" x 39-1/8" x 14-1/8"	82	\$1,688	\$1,840
	60-911-S02 OAK	60-911-S02 MAP	Large Book Truck with Flat Shelves and Rubber Bumpers	43" x 39-1/8" x 14-1/8"	82	\$2,046	\$2,231
	60-911-S03 OAK	60-911-S03 MAP	Large Book Truck with Flat Shelves and All Swivel Casters	43" x 39-1/8" x 14-1/8"	82	\$1,738	\$1,894
	60-911-S04 OAK	60-911-S04 MAP	Large Book Truck with Flat Shelves, Rubber Bumpers and All Swivel Casters	43" x 39-1/8" x 14-1/8"	82	\$2,095	\$2,284

Shelves are tenoned, glued and screwed into the ends. In addition, 3/4" by 3/4" hardwood cleats are glued and screwed under each end of both shelves. Trucks have 13-3/8" clearance between shelves.

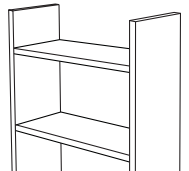
	60-912-S01 OAK	60-912-S01 MAP	Small Book Truck with Flat Shelves	43" x 32-1/2" x 14-1/8"	78	\$1,422	\$1,550
	60-912-S02 OAK	60-912-S02 MAP	Small Book Truck with Flat Shelves and Rubber Bumpers	43" x 32-1/2" x 14-1/8"	78	\$1,782	\$1,942
	60-912-S03 OAK	60-912-S03 MAP	Small Book Truck with Flat Shelves and All Swivel Casters	43" x 32-1/2" x 14-1/8"	78	\$1,471	\$1,603
	60-912-S04 OAK	60-912-S04 MAP	Small Book Truck with Flat Shelves, Rubber Bumpers and All Swivel Casters	43" x 32-1/2" x 14-1/8"	78	\$1,830	\$1,995

Shelves are tenoned, glued and screwed into the ends. In addition, 3/4" by 3/4" hardwood cleats are glued and screwed under each end of both shelves. Trucks have 13-3/8" clearance between shelves.

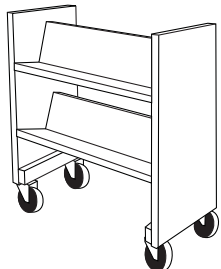
	60-870-S01 OAK	60-870-S01 MAP	Utility Book Truck	31" x 31-9/16" x 13-3/16"	40	\$1,164	\$1,268
	60-870-S02 OAK	60-870-S02 MAP	Utility Book Truck with Rubber Bumpers	31" x 32-9/16" x 13-3/16"	40	\$1,523	\$1,661

Unit has two sloped shelves that are tenoned, glued, and screwed into the ends. The truck is supplied with four heavy-duty swivel casters mounted to solid hardwood caster blocks.

Please specify Wood Finish (Table 1). Details can be found on page GEN 4.

Oak Catalog No.	Maple Catalog No.	Description	H x W x D	Wt. (lbs.)	Oak Price	Maple Price
60-917-S01 OAK	60-917-S01 MAP	Large Book Truck with Double-Faced Display Shelves	43" x 39-1/8" x 17"	80	\$2,056	\$2,242
60-917-S02 OAK	60-917-S02 MAP	Large Book Truck with Double-Faced Display Shelves and Rubber Bumpers	43" x 39-1/8" x 17"	80	\$2,417	\$2,635
60-917-S03 OAK	60-917-S03 MAP	Large Book Truck with Double-Faced Display Shelves and All Swivel Casters	43" x 39-1/8" x 17"	80	\$2,106	\$2,295
60-917-S04 OAK	60-917-S04 MAP	Large Book Truck with Double-Faced Display Shelves, Rubber Bumpers and All Swivel Casters	43" x 39-1/8" x 17"	80	\$2,464	\$2,686

Shelves are tenoned, glued and screwed into the ends. Top two shelves are 7-1/8"H x 5-3/4"D, double-faced and sloped. Bottom shelf is flat.

Large Book Truck with Double-Faced Display Shelves



60-919-S01 OAK	60-919-S01 MAP	Small Book Truck with Double-Faced Display Shelves	43" x 32-1/2" x 17"	75	\$1,792	\$1,953
60-919-S02 OAK	60-919-S02 MAP	Small Book Truck with Double-Faced Display Shelves and Rubber Bumpers	43" x 32-1/2" x 17"	75	\$2,151	\$2,344
60-919-S03 OAK	60-919-S03 MAP	Small Book Truck with Double-Faced Display Shelves and All Swivel Casters	43" x 32-1/2" x 17"	75	\$1,840	\$2,006
60-919-S04 OAK	60-919-S04 MAP	Small Book Truck with Double-Faced Display Shelves, Rubber Bumpers and All Swivel Casters	43" x 32-1/2" x 17"	75	\$2,201	\$2,399

Shelves are tenoned, glued and screwed into the ends. Top two shelves are 7-1/8"H x 5-3/4"D, double-faced and sloped. Bottom shelf is flat.

Small Book Truck with Double-Faced Display Shelves



T0-915-S00	M0-915-S00	Large Depressible Book Receiving Truck	30-3/4" x 26" x 22"	100	\$1,812	\$1,975
T0-915-S02	M0-915-S02	Large Depressible Book Receiving Truck with Rubber Bumpers	30-3/4" x 26" x 22"	100	\$1,957	\$2,133

Fits under 39" circulation desk. Construction is 3/4" edge-banded plywood in flush panel design. The depressible platform is plastic laminated and mounted on a spring mechanism, and has nylon rollers mounted into all four edges for ease of operation and stability. The truck is supplied with four heavy-duty 3" swivel casters mounted to solid hardwood caster blocks. The unit holds approximately 70 average-size books.

Large Depressible Book Receiving Truck

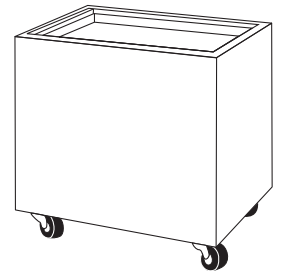

T0-914-S00	M0-914-S00	Small Depressible Book Receiving Truck for 32"H Units	23-3/4" x 26" x 22"	90	\$1,557	\$1,696
T0-914-S02	M0-914-S02	Small Depressible Book Receiving Truck for 32"H Units with Rubber Bumpers	23-3/4" x 26" x 22"	90	\$1,695	\$1,848

Fits under 39" circulation desk. Construction is 3/4" edge-banded plywood in flush panel design. The depressible platform is plastic laminated and mounted on a spring mechanism, and has nylon rollers mounted into all four edges for ease of operation and stability. The truck is supplied with four heavy-duty 3" swivel casters mounted to solid hardwood caster blocks. The unit holds approximately 70 average-size books.

Small Depressible Book Receiving Truck

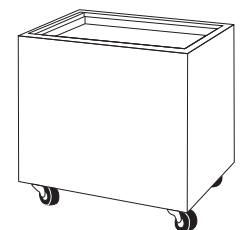

Please specify Wood Finish (Table 1). Details can be found on page GEN 4.

Electrical Accessories



2017 Price List and Specifications

Brodart Co. Contract Furniture - Made in USA

280 North Road, Clinton County Industrial Park • McElhattan, PA 17748

Toll-Free: 888-521-1884 • E-Mail: furniture@brodart.com • www.brodartfurniture.com

General Specifications

The Brodart power distribution system distributes power from the building's power supply to the furniture through the use of power-distribution channels which may be interconnected to allow multiple pieces to be shared from one power source. The components of the system are as follows:

A.) Power entry: Connects the building's power supply and feeds power to the furniture.

B.) Power-distribution channel: Houses duplex electrical outlets to access power and serves as a wire management channel.

C.) J-channel: An optional wire management tray, which may house data jacks. This channel is necessary when additional storage is required or when data lines are run in addition to electrical cords.

POWER-ENTRY ASSEMBLIES

Single-circuit power-entry assembly consist of a wood chase that is fastened to the unit with modular fasteners, a PVC plastic liner fastened to the wood chase, and the power-entry cable which is fastened inside of the PVC liner. The power entry cable has a 24" STO cord fitted with a 20-amp plug at the bottom of the assembly and a flexible metal conduit with a quick-connect coupling at the top. This power-entry assembly is used for single-circuit power distribution systems and provides access to circuit #1. The assembly can be plugged into any 20-amp outlet.

Multiple-circuit power-entry assembly is to be used if more than one circuit is required. The multiple-circuit power-entry assembly consists of a wood chase that is fastened to the unit with modular fasteners, a PVC plastic liner that is fastened to the wood chase and the power-entry cable which is fastened inside the PVC liner. The bottom of the power-entry has a 72" long liquid-tight conduit. Inside the conduit is an eight-wire harness that is wired to four building circuits: three sharing a common ground and one dedicated with an isolated ground.

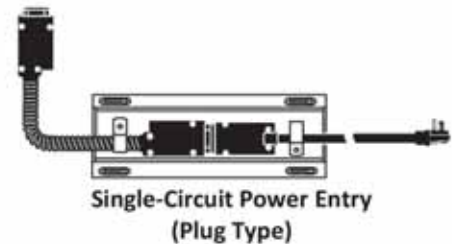

Single-Circuit Power Entry
(Plug Type)

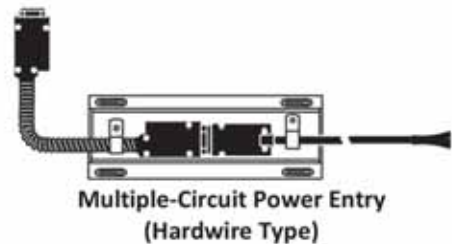

Multiple-Circuit Power Entry
(Hardwire Type)

The top of the power entry consists of a flexible metal conduit and a quick-connect coupling. This power entry is required when more than one circuit or when an isolated with a dedicated ground is required. This assembly must be installed by a qualified licensed electrician. A multiple-circuit system is required under the following conditions:

- 1.) The length of the wiring served by the power entry exceeds 30 feet.
- 2.) The total amperage served by the power entry exceeds 20 amps.
- 3.) A dedicated computer circuit is required. The dedicated computer circuit on system is circuit #4.
- 4.) More than thirteen (13) duplex receptacles are required.

Note: One power-entry assembly is required for each building power source accessed.

PANEL-MOUNT, POWER-DISTRIBUTION CHANNEL

The panel-mount power-distribution channel is constructed of 20-gauge steel and is finished using a black electrostatically applied epoxy powder paint. The channel is open at the top to allow excess wire to be stored behind the power blocks and the duplex receptacles. Front of the channel has cut-outs so two duplex outlets can be mounted. The duplex outlets are rated 15-amps at the receptacle with 20-amps though power. The duplex outlets are connected to each other and the power entry by means of 3/4" flexible metal conduit, which has a quick-connect coupling. The cable consists of an eight-wire, four-circuit system with three standard utility circuits and one isolated circuit with a dedicated ground (computer circuit). If a channel is ordered with one duplex outlet, a plastic cover is provided to cover the unused hole. Units mount to back panels or table keels.

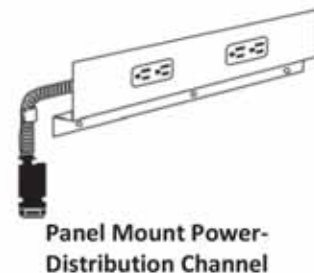

Panel Mount Power-
Distribution Channel

15-AMP POWER-ENTRY LEGS

Power-entry legs are to be used with leg-base tables and computer-access stations. Power-entry legs are available in single circuit only. Power-entry legs are finished to match the other legs on the table.

Note: 15-amp power legs cannot accept power strips. Receptacles are for electrical device only.

WIRE MANAGEMENT LEGS

Wire management legs are to be used with leg-base tables and computer-access stations. Wire management legs are finished to match the other legs on the table and allow wires to be run from the floor to the table inconspicuously.

J-CHANNEL (OPTIONAL)

J-Channel is constructed using 18-gauge steel and is finished using a black electrostatically applied epoxy powder-paint. The J-Channel attaches to the bottom of the power-distribution channel with the same screws that attach the power-distribution channels to the unit. The channel is 3-1/8"H and 4"D; the front lip of the channel is 2"H. The J-Channel provides additional wire-storage capacity or a data wire-management channel when data lines are required. J-Channel has four square holes that hold either communication or data jacks. Unit uses modular insert data jacks, which must be ordered separately.

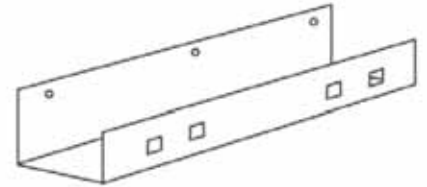

J-Channel

DUPLEX OUTLET RECEPTACLES (Multiple-Circuit System)

Duplex outlets can be ordered to access any of the four circuits available in the power-distribution channel. You must specify the number of the circuit to be accessed for each duplex outlet ordered. Circuit IV outlets access the isolated circuit with the dedicated ground. If circuit numbers are not specified, your power-distribution channels are shipped with circuit one duplex outlet receptacles. Duplex outlets are easily interchanged within the power-distribution assembly by pushing the duplex receptacle sideways and then pulling it out.

When ordering duplex receptacles for circuits I, II, III, or IV, the following catalog numbers should be specified.

Catalog No.	Description	Price
X3 001 S00	Circuit I	\$65
X3 002 S00	Circuit II	\$65
X3 003 S00	Circuit III	\$65
X3 004 S00	Circuit IV (Isolated Circuit)	\$65

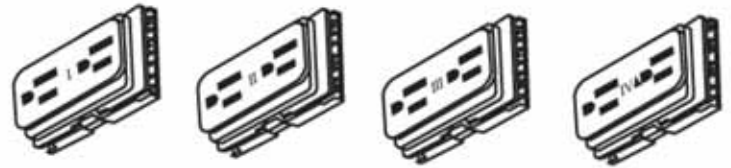

Duplex Outlet Receptacles

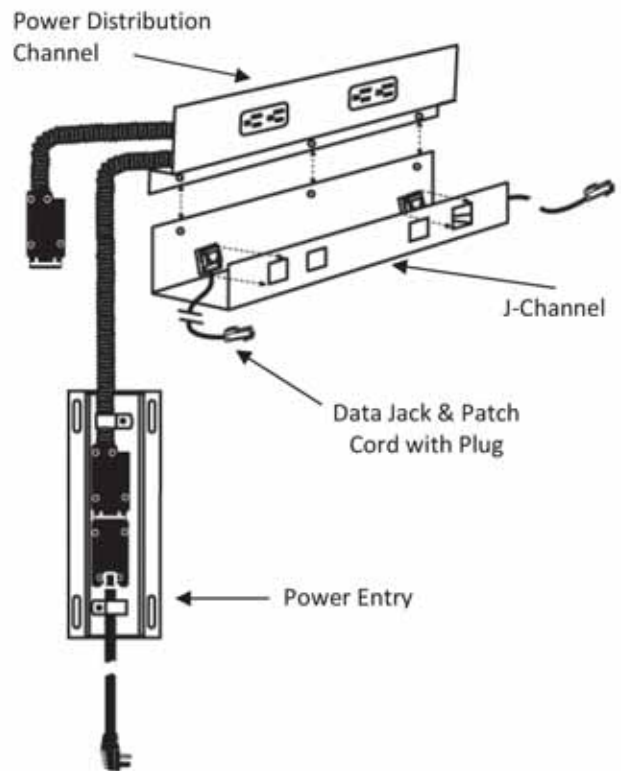

Panel Wire Manager Assembly for Data and Power

The following chart should be used to assist in the selection of electrical components for circulation desks.

Part Number		Power Distribution for Circulation Desks																						
		Single Circuit X3 100-500 (MAP)	Multi Circuit X3 100-502 (MAP)	X3-012-502	X3-017-502	X3-032-502	X3-040-502	X3-011-500	X3-012-500	X3-017-500	X3-032-500	X3-040-500	X3-047-500	X3-311-500	X3-312-500	X3-316-500	X3-317-500	X3-318-500	X3-332-500	X3-340-500	X3-347-500	X3-012-500	X3-047-500	X3-460-500
Circulation Desk Unit	Power Entry	One Duplex Outlet Channel				Two Duplex Outlet Channel				Bypass Channels & Harnesses						Wire Mgmt Trays								
		Bypass Channel						30"W	37"W	44"W														
Single Wide Units																								
XX-012/E12 [SW39/32 PL]	X	X	X				X																	1
XX-014/E14 [SW39/32]	X	X	X				X																	1
XX-015/E15 [SW39/32 BR]	X	X	X				X																	1
XX-E32 [SW32 ADA]				X				X																
XX-121/E21 [SW39/32 COS]	X	X																						
XX-122 [SW39/32 FCD]	X	X																						
XX-123/E23 [SW39/32 CD]	X	X																						
XX-124/E24 [SW39/32 OSD]	X	X																						
XX-131/E31 [SW39/32 CSD]	X	X	X				X																	1
XX-133 [SW39/32 F]	X	X	X				X																	1
XX-135 [SW39/32 FC]	X	X	X				X																	1
XX-172/E72 [SW39/32 D]	X	X	X				X																	1
XX-174/E74 [SW39/32 OS]	X	X	X				X																	1
XX-176/E76 [SW39/32 C]	X	X	X				X																	1
XX-134/E34 [SW39/32 FOS]	X	X	X				X																	1
XX-236/E36 [SW39/32 M5]																								
Double Wide Desks																								
XX-009 [DWAH PL]	X	X																						
XX-011/E11 [DW39/32 PL (35)]	X	X					X																	2
XX-011-SEA [DW39 PL28]	X	X					X																	2
XX-013/E13 [DW39/32]	X	X					X																	2
XX-E37 [DW32 DP]	X	X																						
XX-138/E38 [DW39/32 SP]	X	X																						
Corner Units																								
XX-010/E10 [9039/32 MC]	X	X	X				X																	1
XX-016/E16 [9039/32 CC]																								
XX-017/E17 [9039/32 MCP]	X	X	X				X																	1
XX-018/E18 [4539/32 CC]																								
XX-040/E40 [9039/32 OCCP]	X	X		X					X															2
XX-041/E41 [9039/32 OCC]	X	X		X					X															2
XX-047/E47 [6039/32 CCP]	X	X								X														1
XX-048/E48 [6039/32 CC]	X	X							X															1
XX-055/E55 [9039 CCC]																								
XX-058/E58 [4539/32 CCC]																								
XX-143/E43 [9039/32 OCS]																								
XX-150/E50 [9039 SC]																								

X= Electrical Distribution Channel

O = Bypass Channel

Notes:

If electrical distribution is not required in a given unit within a range of desks, and electric bypass channel can and must be used to continue the run of power to other units in the range.

Wire Management Trays are to be used to separate power from data.

XX-015-E15 Book Return Unit will receive a by-pass in most layout configurations.

All Closed Corner Units receive a factory installed PVC channel for by-pass (sold separately).

Catalog No.	Description	Price
-------------	-------------	-------

UL Listed Electric for Circulation Desks, Oak Wood

X3 100 S00 OAK	Power Entries, All Series, Cord and Plug (Single Circuit)	\$393
X3 100 S02 OAK	Power Entries, All Series, Hardwired (Multiple Circuit)	\$465

UL Listed Electric for Circulation Desks, Maple Wood

X3 100 S00 MAP	Power Entries, All Series, Cord and Plug (Single Circuit)	\$393
X3 100 S02 MAP	Power Entries, All Series, Hardwired (Multiple Circuit)	\$465

Note: Grommets are not always included on product as a standard item. If wires are to be passed through the work surface or from one unit to another, grommets may need to be ordered separately.

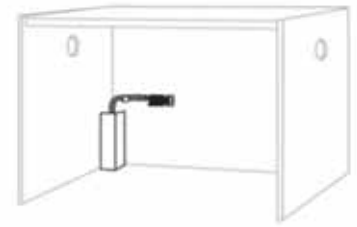

Power Distribution Channels for Circulation Desks, All Series

One Duplex Outlet Channel

X3 012 S02	Circ Desk, One Outlet Channel, SW Unit	\$486
X3 017 S02	Circ Desk, One Outlet Channel, Multipurpose Corner	\$825
X3 032 S02	Circ Desk, One Outlet Channel, ADA Unit	\$605
X3 040 S02	Circ Desk, One Outlet Channel, 90° Curved Corner	\$572

Two Duplex Outlet Channel

X3 011 S00	Circ Desk, Two Outlet Channel, DW Unit	\$608
X3 012 S00	Circ Desk, Two Outlet Channel, SW Unit	\$576
X3 017 S00	Circ Desk, Two Outlet Channel, Multipurpose Corner	\$906
X3 032 S00	Circ Desk, Two Outlet Channel, ADA Unit	\$625
X3 040 S00	Circ Desk, Two Outlet Channel, 90° Curved Corner	\$608
X3 047 S00	Circ Desk, Two Outlet Channel, 60°g Nu-Curve Desk	\$689

Bypass Channels

X3 311 S00	Circ Desk, Bypass Channel, DW Unit	\$573
X3 312 S00	Circ Desk, Bypass Channel, SW Unit	\$447
X3 316 S00	Circ Desk, Bypass Channel, 90° Closed Corner	\$441
X3 317 S00	Circ Desk, Bypass Channel, Multipurpose Corner	\$575
X3 318 S00	Circ Desk, Bypass Channel, 45° Closed Corner	\$441
X3 332 S00	Circ Desk, Bypass Channel, ADA Unit	\$477
X3 340 S00	Circ Desk, Bypass Channel, 90° Curved Corner	\$579
X3 347 S00	Circ Desk, Bypass Channel, 60° Nu-Curve Desk	\$572

Note: This assembly is for units that do not require electrical access but need to have power passed through to the adjoining units. Unit does not include any duplex outlets.

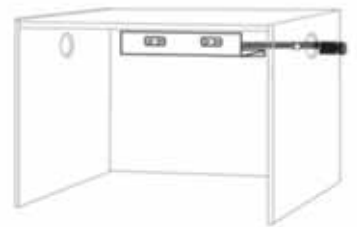
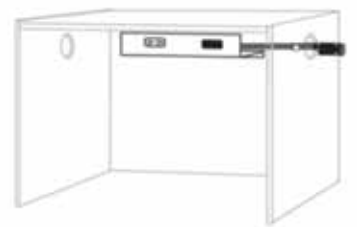

The following chart should be used to assist in the selection of electrical components for carrels and media stations.

Power Distribution and Wire Management for Carrels & MMS

Part Number	Single Circuit	Multi Circuit	X3 673 S02		X3 460 S02		X3 354 S00		X3 454 S00		X3 554 S00		X3 673 S00		X3 460 S00		X1 673 S00		X1 460 S00		
			Power Entry		One Duplex Outlet Channel				Two Duplex Outlet Channel				Wire Mgmt Tray								
Electrical for Carrels																					
36"W Panel Based Carrel	X3 100 S00 (MAP)	X3 100 S02 (MAP)	X								X							O			
48"W Panel Based Carrel	X3 100 S00 (MAP)	X3 100 S02 (MAP)		X										X							O
36"W Panel & Post Carrel	X3 101 S02 (MAP)	X3-101-S02 (MAP)	X								X										O
48"W Panel & Post Carrel	X3 101 S02 (MAP)	X3-101-S02 (MAP)		X										X							O
Electrical for MMS (LTS)																					
36"W Stations	X3 300 S00 (MAP)	X3 300 S02 (MAP)				X															
48"W Stations	X3 300 S00 (MAP)	X3 300 S02 (MAP)						X													
Functional Corner Unit	N/A	N/A								X											

X = Electrical Distribution Channel
 O = Wire Management Tray

Note: Wire Management Trays are to be used for separating data from power

Catalog No.	Description	Price
-------------	-------------	-------

Power Entries for Modular Media Stations, Oak Wood

X3 300 S00 OAK	Power Entry, Cord and Plug (Single Circuit)	\$385
X3 300 S02 OAK	Power Entry, Hardwired (Multiple Circuit)	\$458



Power Entries for Modular Media Stations, Maple Wood

X3 300 S00 MAP	Power Entry, Cord and Plug (Single Circuit)	\$385
X3 300 S02 MAP	Power Entry, Hardwired (Multiple Circuit)	\$458



Note: Grommets are not always included on product as a standard item. If wires are to be passed through the work surface or from one unit to another, grommets may need to be ordered separately.

Power Distribution Channels for Modular Media Stations

One Duplex Outlet

X3 354 S00	36" Wide Position	\$349
X3 454 S00	48" Wide Position	\$377
X3 554 S00	Functional Corner Unit	\$533

Note: This assembly is for units that do not require electrical access but need to have power passed through to the adjoining units.



Power Entries for Panel Based Carrels, Oak Wood Chase

X3 100 S00 OAK	Power Entries, All Series, Cord and Plug (Single Circuit)	\$393
X3 100 S02 OAK	Power Entries, All Series, Hardwired (Multiple Circuit)	\$465

Power Entries for Panel Based Carrels, Maple Wood Chase

X3 100 S00 MAP	Power Entries, All Series, Cord and Plug (Single Circuit)	\$393
X3 100 S02 MAP	Power Entries, All Series, Hardwired (Multiple Circuit)	\$465

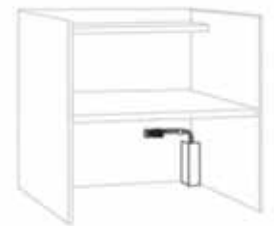

Power Entries for Panel and Post Furniture, Oak Wood Chase

X3 101 S00 OAK	Power Entries, All Series, Cord and Plug (Single Circuit)	\$393
X3 101 S02 OAK	Power Entries, All Series, Hardwired (Multiple Circuit)	\$465

Power Entries for Panel and Post Furniture, Maple Wood Chase

X3 101 S00 MAP	Power Entries, All Series, Cord and Plug (Single Circuit)	\$393
X3 101 S02 MAP	Power Entries, All Series, Hardwired (Multiple Circuit)	\$465



Power Distribution Channels for Carrels

One Duplex Outlet

X3 673 S02	36" Wide Position	\$486
X3 460 S02	48" Wide Position	\$501

Two Duplex Outlet

X3 673 S00	36" Wide Position	\$569
X3 460 S00	48" Wide Position	\$595

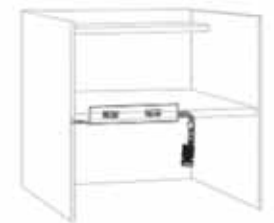

Note: Grommets are not always included on product as a standard item. If wires are to be passed through the work surface or from one unit to another, grommets may need to be ordered separately.



Catalog No.	Description	Price
-------------	-------------	-------

Quorum 94 Series Plate Style, 15-Amp Power-Outlet Leg, Oak Wood Veneer

X1 941 S00 OAK	Leg & Plate Type for 29"H Table	\$597
X1 941 S02 OAK	Leg & Plate Type for 27-1/2"H Table	\$593
X1 941 S03 OAK	Leg & Plate Type for 25"H Table	\$582
X1 941 S04 OAK	Leg & Plate Type for 32"H Table	\$638

Quorum 94 Series Plate Style, 15-Amp Power-Outlet Leg, Maple Wood Veneer

X1 941 S00 MAP	Leg & Plate Type for 29"H Table	\$650
X1 941 S02 MAP	Leg & Plate Type for 27-1/2"H Table	\$646
X1 941 S03 MAP	Leg & Plate Type for 25"H Table	\$634
X1 941 S04 MAP	Leg & Plate Type for 32"H Table	\$695

Quorum 94 Series Apron Style, 15-Amp Power-Outlet Leg, Oak Wood Veneer

X1 942 S00 OAK	Leg & Apron Type for 29"H Table	\$556
X1 942 S04 OAK	Leg & Apron Type for 32"H Table	\$596
X1 942 S05 OAK	Leg & Apron Type for 39"H Table	\$636

Quorum 94 Series Apron Style, 15-Amp Power-Outlet Leg, Maple Wood Veneer

X1 942 S00 MAP	Leg & Apron Type for 29"H Table	\$606
X1 942 S04 MAP	Leg & Apron Type for 32"H Table	\$649
X1 942 S05 MAP	Leg & Apron Type for 39"H Table	\$693

Leg is 2-1/4" square, 1/8" thick wall, aluminum extrusion with 3/4" radius on the outside corners. Leg is oak veneer wrapped to match other legs on the table and has three receptacles for power outlet and a 2' SJT power cord. A Hi-Pot Test of insulation and connections of 1,200 volts is given to each leg.

Note: The use of grommets for wire passage through the work surface is recommended. 15-amp power legs cannot accept power strips. Receptacles are for electrical device only.

Catalog No.	Description	Price
-------------	-------------	-------

Chancellor's Series Wire Management Leg

Round Leg Style

X3 CHR6 S00	Leg & Apron Type for 29"H Table	\$287
X3 CHR6 S02	Leg & Apron Type for 27-1/2"H Table	\$287
X3 CHR6 S03	Leg & Apron Type for 25"H Table	\$287
X3 CHR6 S04	Leg & Apron Type for 32"H Table	\$287

Square Leg Style

X3 CH25 S00	Leg & Plate Type for 29"H Table	\$287
X3 CH25 S02	Leg & Plate Type for 27-1/2"H Table	\$287
X3 CH26 S05	Leg & Apron Type for 39"H Table	\$287

Leg is constructed according to standard Chancellor Series Leg construction. Leg is slotted 4" from the top and 2-1/2" from the bottom with a 1/2" W slot. Slots receive a snap-on metal cover, which allows a 1" opening at the top and bottom of the slot for cord exit. Slot accepts two 3/8" power cords or four data cables.



Epoch Series Wire Management Leg

Powder-Coated Leg Style

59 945 S00	Powder-Coated Leg for 29"H Table	\$331
59 945 S02	Powder-Coated Leg for 27-1/2"H Table	\$332
59 945 S03	Powder-Coated Leg for 25"H Table	\$331

Chrome Leg Style

59C 945 S00	Chrome Leg for 29"H Table	\$655
59C 945 S02	Chrome Leg for 27-1/2"H Table	\$643
59C 945 S03	Chrome Leg for 25"H Table	\$643

Oak Wood Leg Style

59W 945 S00 OAK	Wood Leg for 29"H Table	\$388
59W 945 S02 OAK	Wood Leg for 27-1/2"H Table	\$388
59W 945 S03 OAK	Wood Leg for 25"H Table	\$388

Maple Wood Leg Style

59W 945 S00 MAP	Wood Leg for 29"H Table	\$388
59W 945 S02 MAP	Wood Leg for 27-1/2"H Table	\$388
59W 945 S03 MAP	Wood Leg for 25"H Table	\$388

Leg is constructed according to standard Epoch leg construction. The leg will receive a 3/4" wide slot located in the back of the leg underneath the angle bracket, 6-5/16" down from the top of the leg and 2-1/4" from the bottom of the leg. A spring loaded cover of 1/8" bent metal will provide access and storage of electrical cords. The spring loaded cover will provide a 1" D egress at the top and bottom of the slot for cords. The leg is powder coated, chromed, or wrapped in wood veneer according to the product specified.

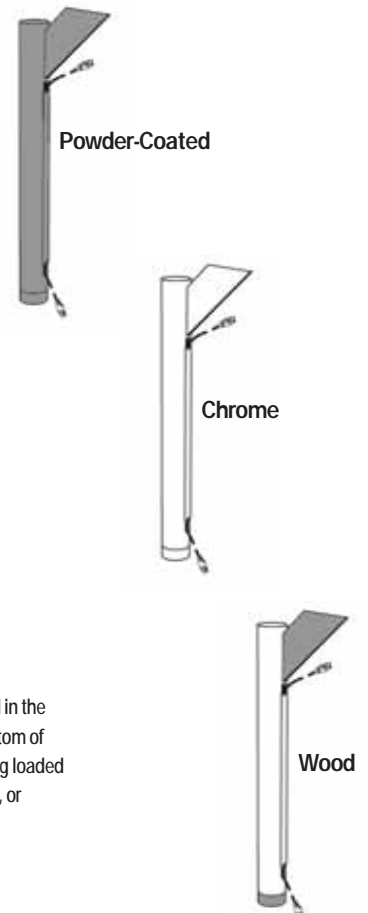



Catalog No.	Description	Price
<i>Quorum 94 Series Wire Management Leg</i>		
X3 945 S00	Leg & Plate Type for 29"H Table	\$267
X3 945 S02	Leg & Plate Type for 27-1/2"H Table	\$267
X3 945 S03	Leg & Plate Type for 25"H Table	\$267
X3 945 S04	Leg & Plate Type for 32"H Table	\$267
X3 946 S00	Leg & Apron Type for 29"H Table	\$267
X3 946 S04	Leg & Apron Type for 32"H Table	\$267
X3 946 S05	Leg & Apron Type for 39"H Table	\$267

Leg is constructed according to standard Quorum 94T Leg construction.
 Leg is slotted 4" from the top and 2-1/2" from the bottom with a 1/2" W slot.
 Slots receive a snap-on veneer wrapped cover, which allows a 1" opening at the top and bottom of the slot for cord exit. Slot accepts two 3/8" power cords or four data cables.

Catalog No.	Description	Price
-------------	-------------	-------

Duplex Outlet Receptacles

X3 001 S00	Circuit I	\$65
X3 002 S00	Circuit II	\$65
X3 003 S00	Circuit III	\$65
X3 004 S00	Circuit IV (Isolated Circuit)	\$65



Circuit I receptacles are supplied as standard. When ordering duplex receptacles for circuits II, III or IV, the following numbers should be specified.

Data/Communication Terminal & Jacks

X3 005 S00	RJ11 Telephone Jack	\$37
X3 007 S00	RJ45 Category Five Data Jack	\$40
X3 007 S02	RJ45 Category Five Data Jack w/9 ft Patch Cord	\$65
X3 007 S03	RJ45 Category Five Data Jack w/12 ft Patch Cord	\$69



Note: Data jacks are wired for TIA/EIA T568A.

Horizontal Surface-Mount Data Outlet Box without Data Jacks & Cables

X1 700 074	Horizontal Data Outlet Box Constructed of black ABS plastic, box is designed for use in the horizontal mounting of data. This box inter-members with the X1 700 065 and X1 700 066 raceways. Capacity of two jacks.	\$66
------------	--	------



Note: Data jacks not included.

Vertical Date Outlet Box without Data Jacks

X1 700 070	Vertical Data Outlet Box Constructed of black ABS plastic, box is designed for use in the vertical mounting of data. This box inter-members with the X1 700 065 and X1 700 066 raceways. Capacity of two jacks.	\$99
------------	--	------



Note: Data jacks not included.

Power Strips

X1 700 112	Power Strip, 3 Outlet Power Strip with a 9' SJT Cord	\$65
73 200 S00	Electrical Interport w/2 outlets & 2 ports for data (purchase data separately)	\$267
73 258 S00	15-amp Power/Data Strip This unit consists of an outlet strip with four surge-protected electrical outlets and two RJ45 category 5 data jacks. Unit has two 9' patch cords for data and a 9' power cord. Unit has a resettable circuit breaker.	\$305

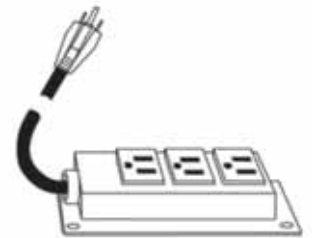

Note: Grommets are not always included on product as a standard item. If wires are to be passed through the work surface or from one unit to another, grommets may need to be ordered separately.

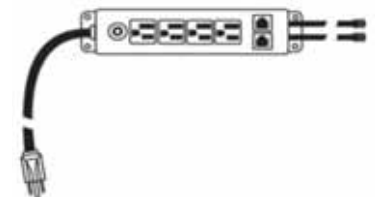

Catalog No.	Description	Price
<u>Tabletop/Worksurface Distribution</u>		
<u>Corner Mounted Power/Communication Center</u>		
73 560 S00	Corner Power Unit Constructed of black ABS plastic, the unit has four electrical outlets; three above the work surface, one below. The unit mounts in the corner of a carrel or PAC station. Unit comes with a nine foot SJT power cord.	\$258
73 559 S00	Corner Power and Communication Center without Patch Cords	\$436
73 559 S02	Corner Power and Communication Center with 9' Patch Cords Constructed of black ABS plastic, the unit has four electrical outlets; three above the work surface, one below. Unit also has a data module which allows for up to three data jacks. Unit comes standard with two RJ45 Category 5 data jacks. The unit mounts in the corner of a carrel or PAC station. Unit comes with a nine foot SJT power cord and can be ordered with or without nine foot data patch cords.	\$473
Note: Data jacks are wired for TIA/EIA T568A.		

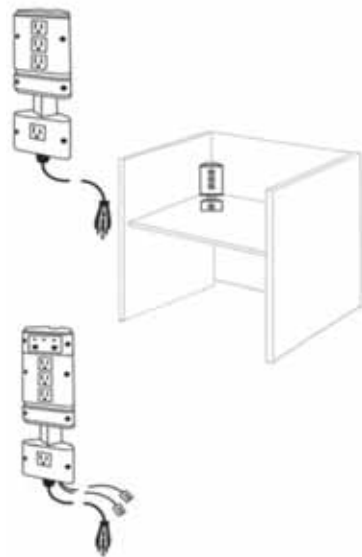

<u>Tabletop/Worksurface Distribution</u>		
<u>OPAC Station Power Assembly</u>		
73 274 S00	Panel Power Assembly for 3-, 4- and 6-Position PAC Station Overall dimensions: 14"H x 27-1/2"W x 2"D Power assembly panel is constructed of 3/4" veneered particleboard with 2-1/2"D cleats on the end for mounting to the PAC unit. The assembly is installed in the well created in the center of the PAC stations. The power assembly has two six-outlet, 15-amp power strips. Each outlet strip has a 9' SJT power cord. Space is available on the panel for future data patch panel requirements.	\$895
Note: Outlets are for electrical devices only and are not for plugging in power strips.		

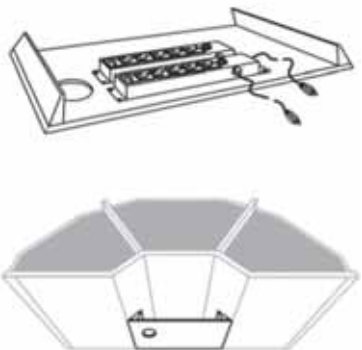

<u>Tabletop/Worksurface Distribution</u>		
<u>Panel Table Power and Data Outlet</u>		
73 280 S00	Panel Mounted Power and Data Outlet Overall dimensions: 2-3/4" x 8-1/2" x 3-3/8"D Unit is constructed using the same species of wood and the same finish as the unit on which it is mounted. The unit has three 15-amp electrical outlets with resettable circuit breaker and is provided with a 9' SJT cord and two RJ45 category 5 data jacks with nine foot patch cords.	\$589
Note: Outlets are for electrical devices only and are not for plugging in power strips.		



Catalog No.	Description	Price
-------------	-------------	-------

Tabletop/Worksurface Distribution
Single-Faced Tilt Up Power and Data Center

73 268 S00	<p>S/F Tilt Up Power and Data Center Overall dimensions: 10"W x 5-3/4"D Tilt up data and power center is constructed from 18-gauge steel painted black. The unit has three electrical outlets with resettable circuit breaker and comes standard with two RJ45 category 5 data jacks with 9' patch cords and a 9' SJT cord. The access door is spring loaded and opens to an approximate 42° angle. The access door is held closed with a spring-loaded clasp. Unit mounts into the tabletop. Door opening is 4-1/4"D x 8-3/8"W.</p>	\$572
------------	--	-------

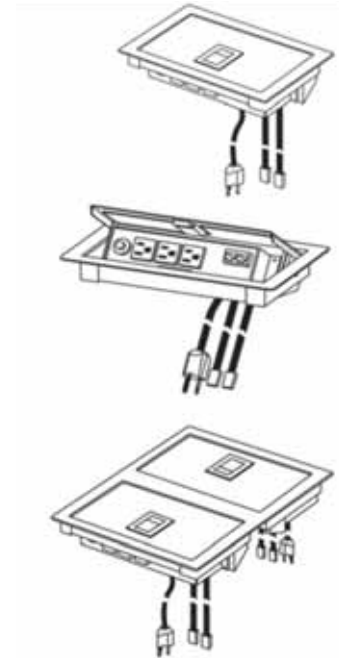

Tabletop/Worksurface Distribution
Double-Faced Tilt Up Power and Data Center

73 368 S00	<p>D/F Tilt Up Power and Data Center Overall dimensions: 10"W x 10-3/4"D Tilt up data and power center is constructed from 18-gauge steel painted black. The unit has six electrical outlets with resettable circuit breaker and comes standard with four RJ45 category 5 data jacks with 9' patch cords and two 9' SJT cords. The access doors are spring loaded and open to an approximate 42° angle. The access door is held closed with a spring-loaded clasp. Unit mounts into the tabletop. Door opening is 4-1/4"D x 8-3/8"W.</p>	\$1,195
------------	--	---------

Note: Data jacks are wired for TIA/EIA T568A. For factory cutout to install the unit, a sketch must be provided to show the unit in the work surface with dimensions noting the exact location.

Tabletop/Worksurface Distribution
Table Power Tap, Round

XSU PT4RD S	<p>Table Power Tap, Round Unit is designed to allow hidden power and data access in a work surface. Constructed of black ABS plastic, the unit contains three (3) 15-amp outlets and two (2) Cat 5 Ethernet connections. Power cord is 8' in length. Unit fits into a 4-7/32" diameter hole and overall dimension is 4-3/8" diameter.</p>	\$298
-------------	---	-------

Note: For factory cutout to install the unit, a sketch must be provided to show the unit in the work surface with dimensions noting the exact location.



Power Sphere (Fits into Standard 3" Grommet Hole)
Two Outlets per sphere - 8 spheres can be linked off one plug (in sequential order)

XBE01640L1 S	Power Sphere Starter, Link 1, 10' Cord & Plug	\$312
XBE01640L2 S	Power Sphere Adder, Link 2, 5' Cord (Black/Red)	\$239
XBE01640L3 S	Power Sphere Adder, Link 3, 5' Cord (Red/Blue)	\$239
XBE01640L4 S	Power Sphere Adder, Link 4, 5' Cord (Blue/Orange)	\$239
XBE01640L5 S	Power Sphere Adder, Link 5, 5' Cord (Orange/Yellow)	\$239
XBE01640L6 S	Power Sphere Adder, Link 6, 5' Cord (Yellow/Green)	\$239
XBE01640L7 S	Power Sphere Adder, Link 7, 5' Cord (Green/White)	\$239
XBE01640L8 S	Power Sphere Adder, Link 8, 5' Cord (White)	\$239

Unit is designed to fit into a standard 3" grommet hole. This 15A system can link up to 8 duplex devices (must be connected in sequence). Each module contains two outlets.

Note: For factory cutout to install the unit, a sketch must be provided to show the unit in the work surface with dimensions noting the exact location.







General Specifications

Have electrical power and data access conveniently located; where you need it and in the format required by your computer system and all other electrically powered equipment. Prevent wire clutter by storing excess cables and wires in wire-management channels.

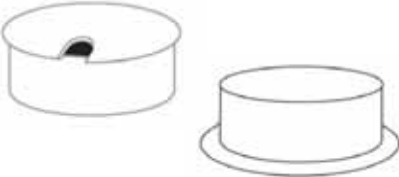
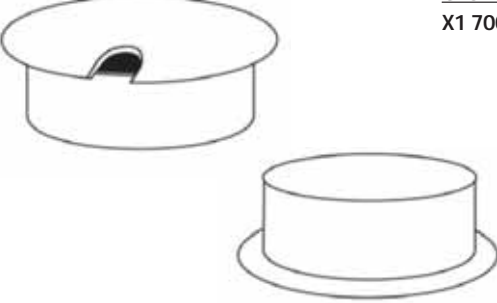
Based upon your specification, Brodart provides single or multi-circuit power systems with optional dedicated computer circuitry. Also, a choice of 15-amp or 20-amp systems, as you specify. Quick-connect cable couplings are utilized by Brodart to permit easy, on-site installations and to provide for rearrangement as changing needs dictate.

NOTES: Grommets are not always included as standard with the product. If wires are to be passed through work surfaces or from one unit to another you will need to order the grommets separately. For factory-cut holes to install grommets, a sketch must be provided to show the unit in the work surface with dimensions noting the exact location.

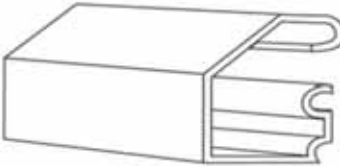
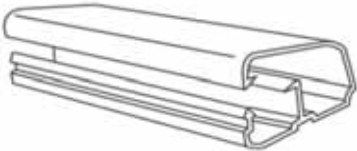
Catalog No.	Description	Price
 <u>Grommet with Cap, 2" Round</u> X1 700 001	Grommet with Cap, 2" Round Constructed Black of ABS plastic, 2" round grommet fits 1-3/4" diameter hole. Nominal 1-5/8" inside diameter. Includes notched 5/8" W removable cap.	\$64
 <u>Grommet with Cap, 3-1/2" Round</u> X1 700 002	Grommet with Cap, 3-1/2" Round Constructed Black of ABS plastic, 3-1/2" round grommet fits 3" diameter hole. Nominal 2-7/8" inside diameter. Includes notched 5/8" W removable cap.	\$72
 <u>Grommet with Paper Slot, 17" Long</u> X1 700 111	Grommet with Paper Slot, 17" Long Constructed Black of ABS plastic. Inside dimensions are 17" x 1".	\$151

Catalog No.	Description	Price	
<i>Plastic J-Channel Wire Manager</i>			
X1 700 020	<p>Plastic J-Channel Wire Manager Constructed of dark brown ABS plastic. Designed to be mounted by screwing or stapling to most surfaces. Front "J" is flexible for inserting cords. Inside dimensions: 1-1/2"H x 1"W x 72"L</p>	\$86	
<i>Data and Communication Raceway, 1/2"H x 1"W x 6'L</i>			
X1 700 065	<p>Data and Communication Raceway, 1/2"H x 1"W x 6'L One-piece, black, latching surface raceway for low voltage communications cabling applications. Supplied with preapplied adhesive-backed tape for trouble-free and permanent mounting. Will hold up to four data cables. Can be used with category 5 and fiber optic cabling applications.</p>	\$107	
<i>Power Data Raceway, 7/8"H x 1-1/2"W x 10'L</i>			
X1 700 066	<p>Power Data Raceway, 7/8"H x 1-1/2"W x 10'L One-piece, brown, latching surface raceway for data, voice, video, fiber optic and power cabling applications. Unit has two channels that can route both power and data. Supplied with preapplied adhesive-backed tape for trouble-free and permanent mounting. Unit requires screw mounting when using for power applications.</p>	\$164	
<i>Wire Manager For Table Mounting</i>			
X1 700 030	22" J-Channel, 3-1/2"H x 22"W x 3-1/4"D	\$72	
X1 700 031	28" J-Channel, 3-1/2"H x 28"W x 3-1/4"D	\$92	
<p>Designed for electrical or data cables, unit is constructed of 18-gauge steel with electrostatically applied black powder-paint. Designed to be mounted to the underside of a tabletop.</p> <p>Note: Grommets are not always included on product as a standard item. If wires are to be passed through the work surface or from one unit to another, grommets may need to be ordered separately.</p>			
<i>Wire Manager For Panel Mounting</i>			
XJ 012 S00	30" J-Channel, 3-1/8"H x 30"W x 4"D	\$145	
XJ 673 S00	32" J-Channel, 3-1/8"H x 32"W x 4"D	\$145	
XJ 047 S00	38" J-Channel, 3-1/8"H x 38"W x 4"D	\$164	
XJ 460 S00	44" J-Channel, 3-1/8"H x 44"W x 4"D	\$175	
<p>Designed for electrical or data cables, unit is constructed of 18-gauge steel with electrostatically applied black powder-paint. The front lip of the panel is 2"H. Unit mounts to back panels or keels.</p> <p>Note: Grommets are not always included on product as a standard item. If wires are to be passed through the work surface or from one unit to another, grommets may need to be ordered separately. Modular insert data jacks sold separately.</p>			



Catalog No.	Description	Price
-------------	-------------	-------

Vertical Wire Chase, Oak Wood

X1 700 195 OAK	Wood Wire Chase for 25"H Work Surface, Actual height 22"	\$164
X1 700 197 OAK	Wood Wire Chase for 29"H Work Surface, Actual height 26"	\$205
X1 700 199 OAK	Wood Wire Chase for 39"H Work Surface, Actual height 36"	\$223

Vertical Wire Chase, Maple Wood

X1 700 195 MAP	Wood Wire Chase for 25"H Work Surface, Actual height 22"	\$164
X1 700 197 MAP	Wood Wire Chase for 29"H Work Surface, Actual height 26"	\$205
X1 700 199 MAP	Wood Wire Chase for 39"H Work Surface, Actual height 36"	\$223

Designed to manage cords below the work surface, unit is constructed the wood species specified and finished to match. Inside Dimensions are 2-1/4" x 3"



Flexible Wire Management Channels (Leg Style)

73 210 S00	32" for Sitting Height Tables	\$329
73 210 S01	39" for Standing Height Tables	\$362



Metal Vertical Wire Manager

X1 700 050	Vertical Wire Manager for Table Mounting Designed to be mounted underneath the work surface below a grommet. Unit is constructed of a 3-1/2" diameter steel tube and finished with black electrostatically applied powder paint.	\$254
------------	--	-------